



US00D713182S

(12) **United States Design Patent**
Longacre

(10) **Patent No.:** **US D713,182 S**

(45) **Date of Patent:** **** Sep. 16, 2014**

(54) **MULTI-PURPOSE GUITAR STAND**

(71) Applicant: **Michael Alan Longacre**, Hermosa Beach, CA (US)

(72) Inventor: **Michael Alan Longacre**, Hermosa Beach, CA (US)

(**) Term: **14 Years**

(21) Appl. No.: **29/485,929**

(22) Filed: **Mar. 25, 2014**

(51) **LOC (10) Cl.** **06-06**

(52) **U.S. Cl.**
USPC **D6/682**

(58) **Field of Classification Search**
USPC D6/396-397, 449-450, 466-467, 509,
D6/672-673, 682-682.4; D14/447;
248/166; 211/1-2, 13.1, 44-45, 72,
211/85.2, 85.6, 85.8, 85.14, 85.31, 86.01
See application file for complete search history.

(56) **References Cited**

U.S. PATENT DOCUMENTS

3,312,503	A *	4/1967	Suzuki	297/440.12
D252,001	S *	6/1979	Arnold	D6/552
D347,527	S *	6/1994	Breen et al.	D6/349
5,445,435	A *	8/1995	Sheckles	297/440.12
D362,125	S *	9/1995	Crust	D6/349
D460,566	S *	7/2002	Henschel et al.	D25/65

D558,991	S *	1/2008	Vardy	D6/353
D577,833	S *	9/2008	Eveleth	D25/65
D610,304	S *	2/2010	Hong et al.	D28/9
7,721,899	B2 *	5/2010	Lambert	211/65
D651,818	S *	1/2012	Omori	D6/349
8,167,148	B2 *	5/2012	Jacobson et al.	211/85.6
D675,039	S *	1/2013	Foisy	D6/682
D689,718	S *	9/2013	Puckett	D6/683
D702,065	S *	4/2014	Moore	D6/682.4

* cited by examiner

Primary Examiner — Kelley Donnelly

(57) **CLAIM**

The ornamental design for a multi-purpose guitar stand, as shown and described.

DESCRIPTION

FIG. 1 is a perspective front view of a multi-purpose guitar stand, shown in use as a stool;

FIG. 2 is a perspective bottom view of the multi-purpose guitar stand, shown in use as a guitar stand;

FIG. 3 is a front elevation view of the multi-purpose guitar stand, rear elevation view is a mirror image thereof;

FIG. 4 is a left side elevation view of the multi-purpose guitar stand, right side elevation view is a mirror image thereof;

FIG. 5 is a top plan view of the multi-purpose guitar stand; and,

FIG. 6 is a bottom plan view of the multi-purpose guitar stand. The guitar and guitarist figure are shown in broken lines for illustrative purposes only and form no part of the claimed design.

1 Claim, 4 Drawing Sheets

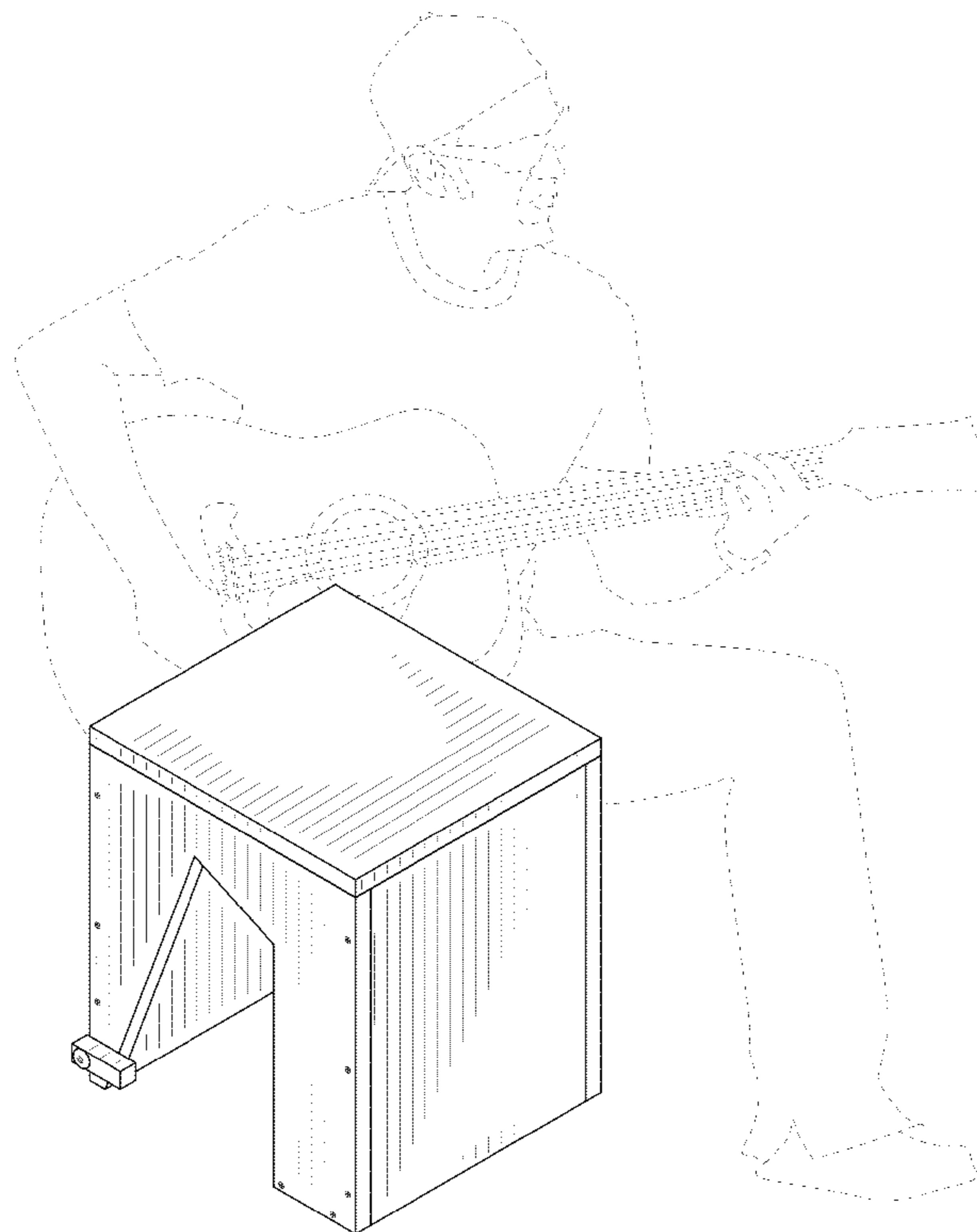

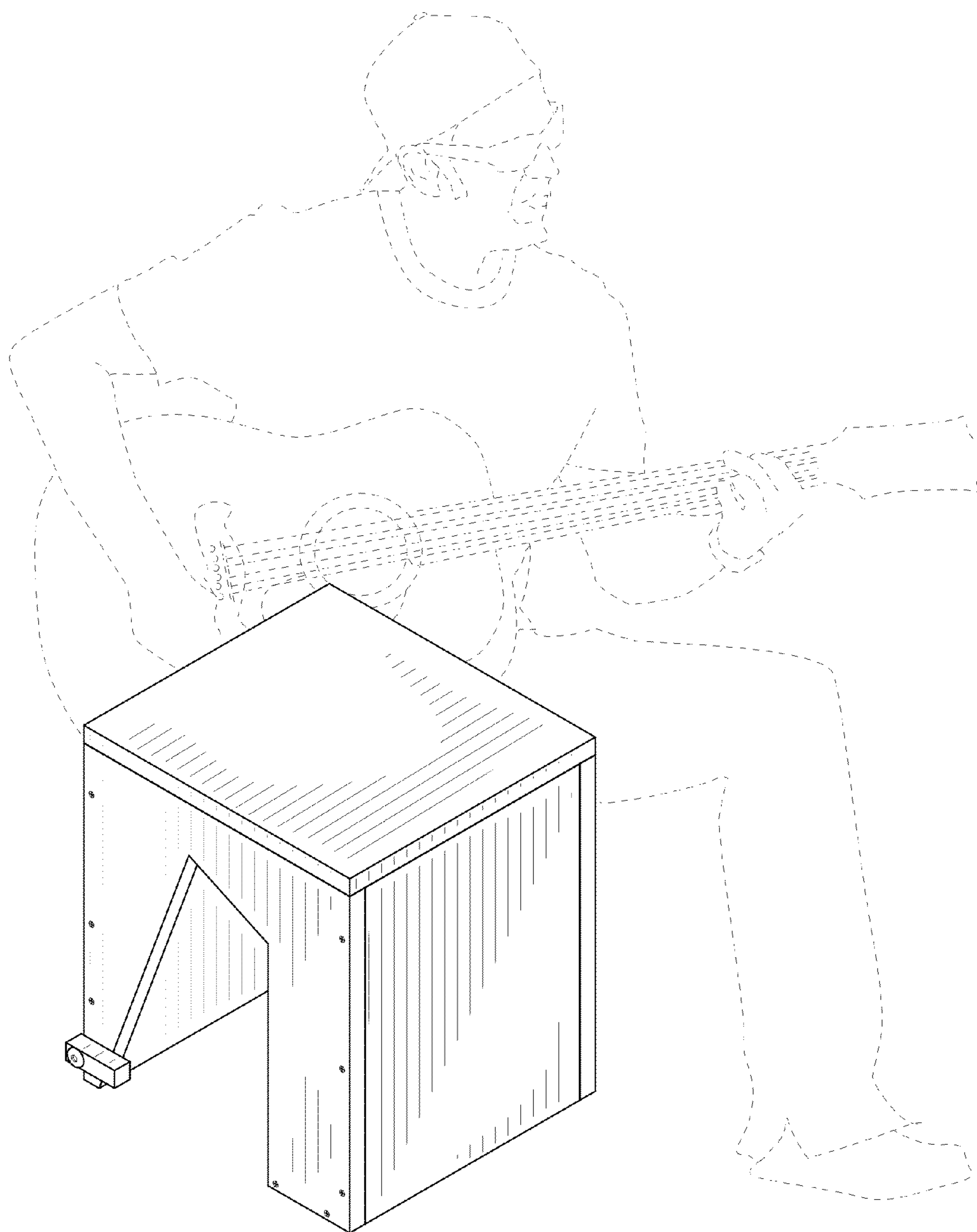

FIG. 1

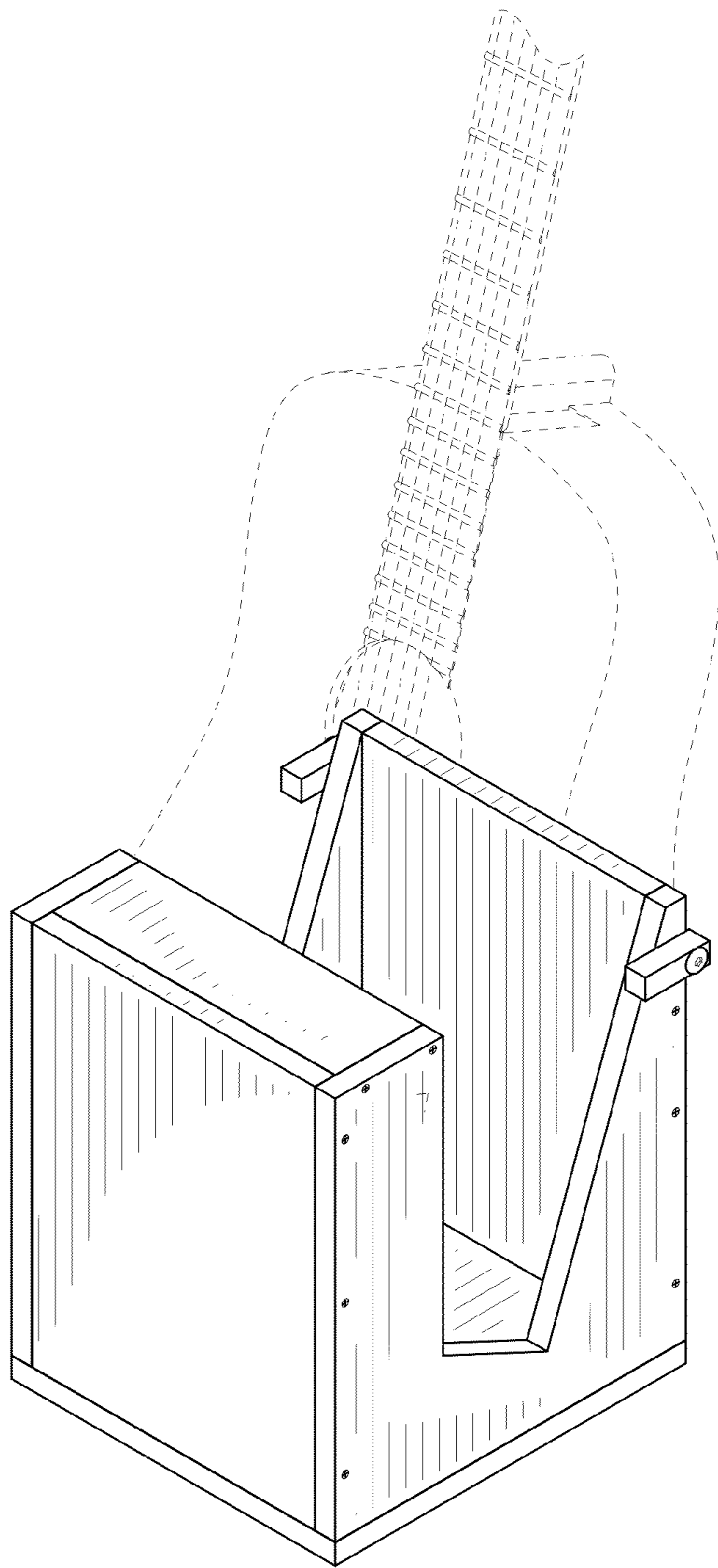

FIG. 2

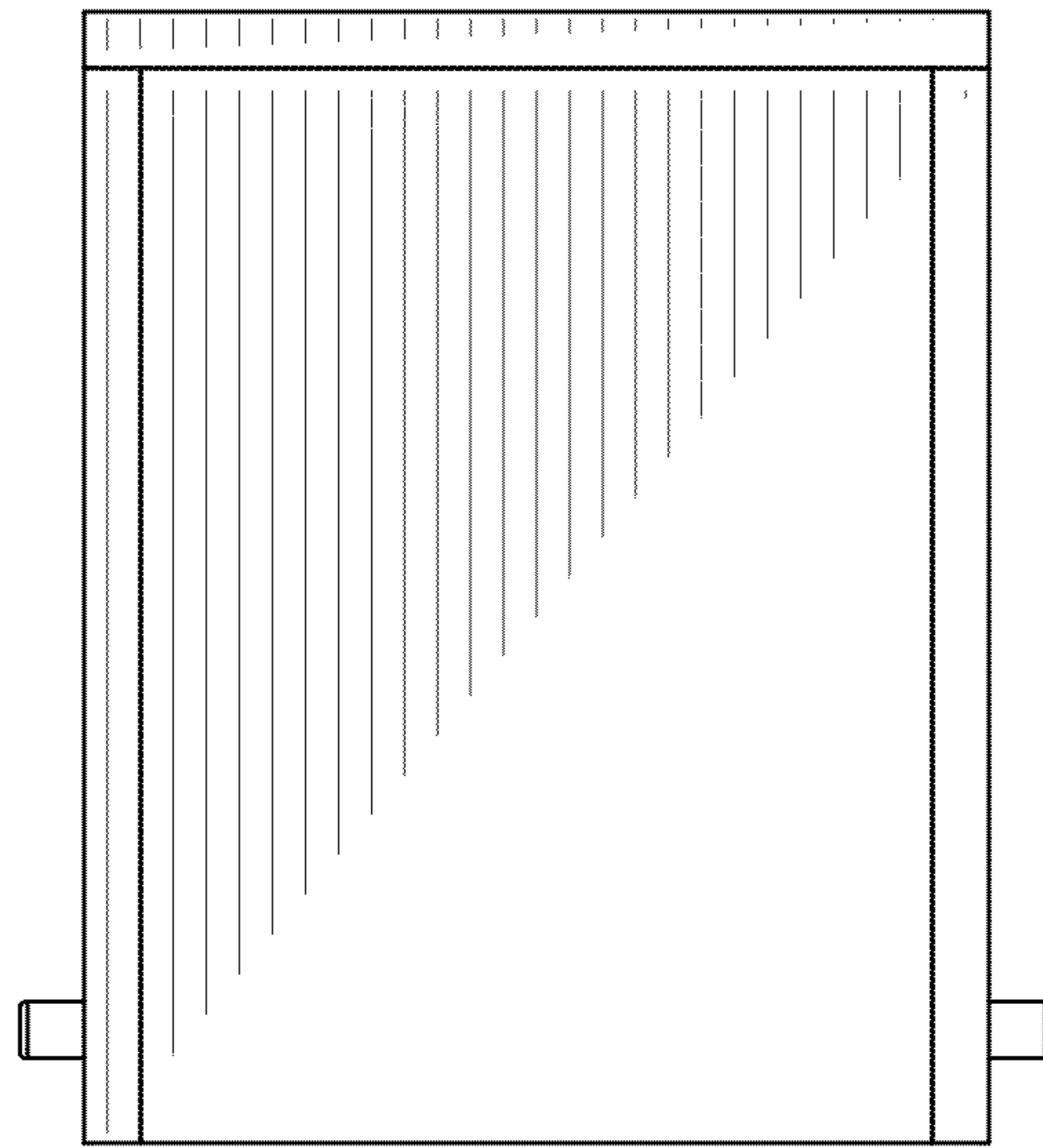

FIG. 3

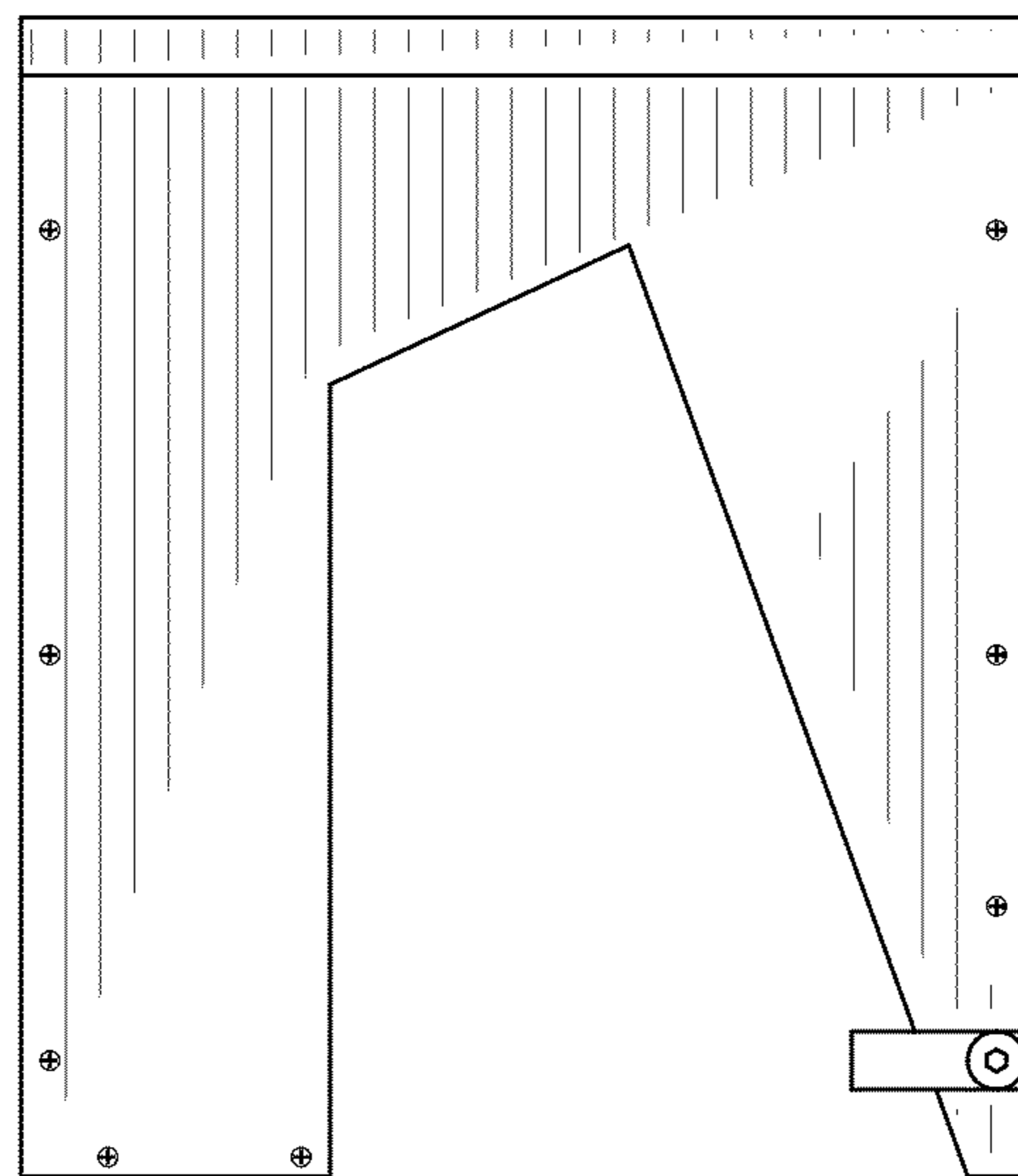

FIG. 4

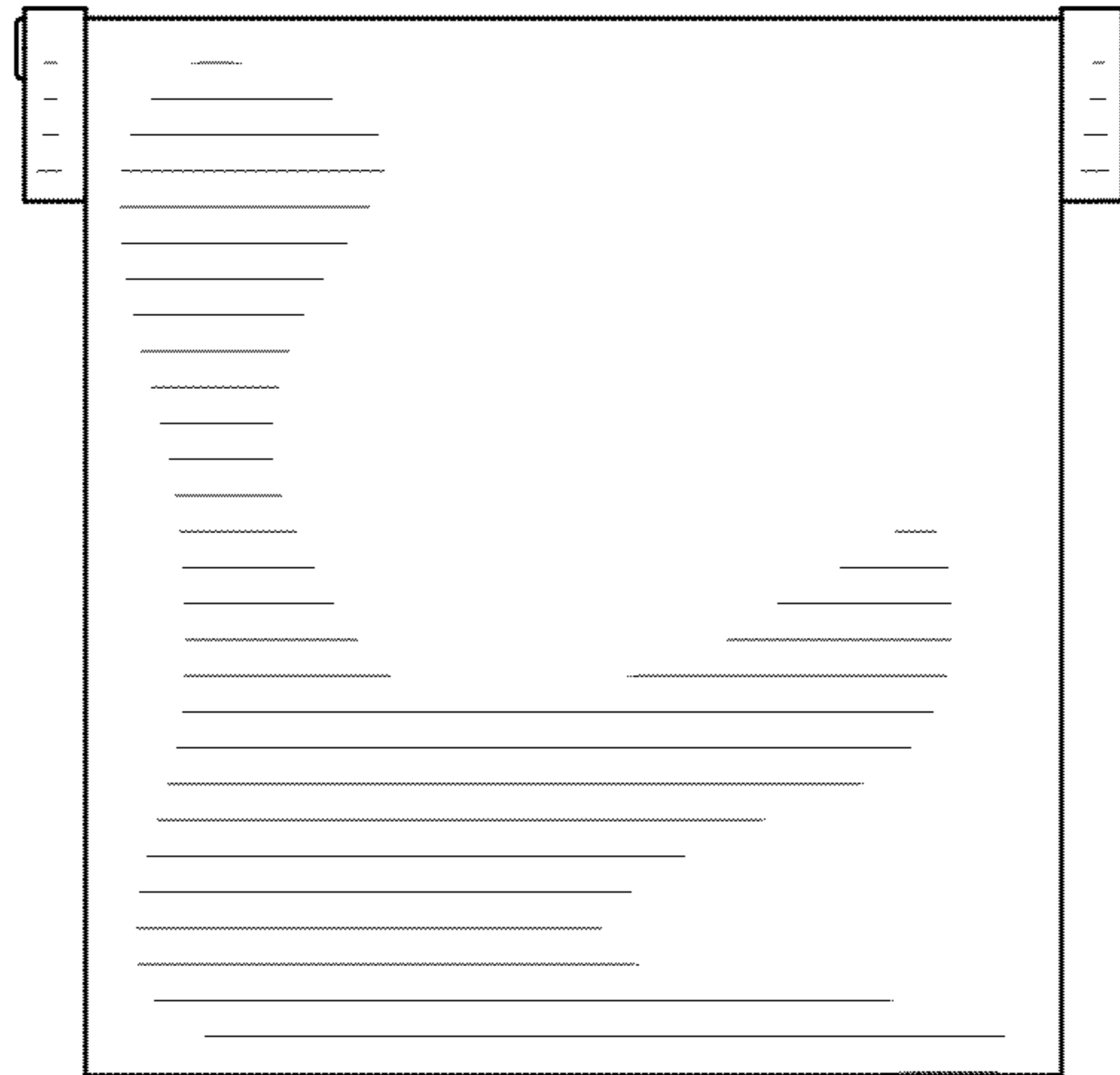

FIG. 5

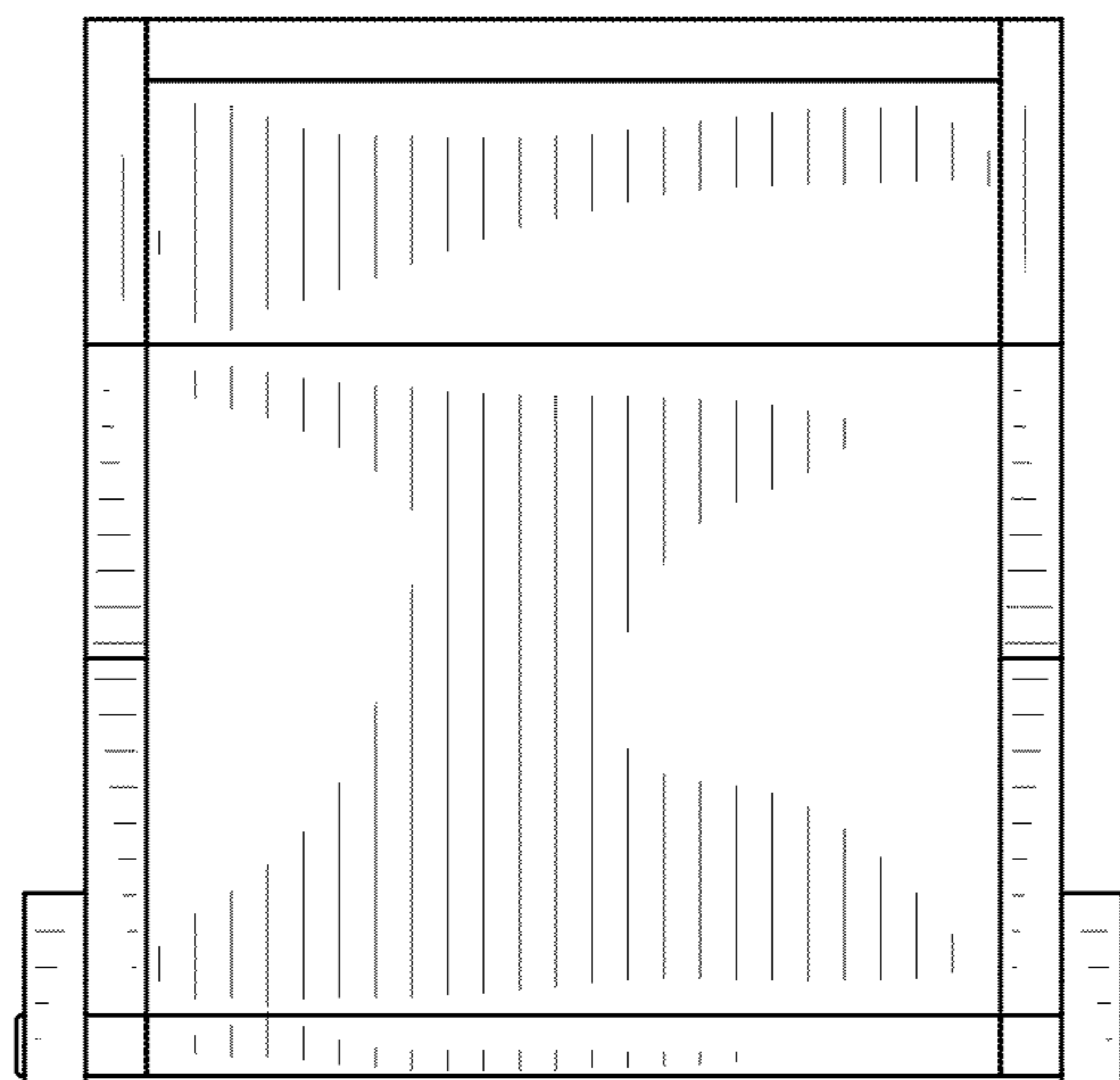

FIG. 6