



US00D713167S

(12) **United States Design Patent**  
**Snell**

(10) **Patent No.:** **US D713,167 S**

(45) **Date of Patent:** **\*\* Sep. 16, 2014**

(54) **DISPENSER**

(71) Applicant: **InterDesign, Inc.**, Solon, OH (US)

(72) Inventor: **Russell Benton Snell**, Bentleyville, OH  
(US)

(73) Assignee: **InterDesign, Inc.**, Solon, OH (US)

(\*\*) Term: **14 Years**

(21) Appl. No.: **29/472,238**

(22) Filed: **Nov. 11, 2013**

**Related U.S. Application Data**

(62) Division of application No. 29/411,666, filed on Jan. 25, 2012, now Pat. No. Des. 694,548.

(51) **LOC (10) Cl.** ..... **23-02**

(52) **U.S. Cl.**  
USPC ..... **D6/542**

(58) **Field of Classification Search**  
USPC ..... D6/542-545; D9/682, 688, 690, 291,  
D9/448, 449; 221/282; 222/14, 173, 146.3,  
222/628, 251, 181.1, 181.3

See application file for complete search history.

(56) **References Cited**

U.S. PATENT DOCUMENTS

D578,814 S *	10/2008	Dretzka .....	D6/542
D599,598 S *	9/2009	Ghiorghie .....	D6/542
D619,397 S *	7/2010	Snell .....	D6/542
D635,808 S *	4/2011	DeBretton Gordon .....	D6/542
D637,847 S *	5/2011	Kraemer .....	D6/542
D661,148 S *	6/2012	Yang et al. ....	D6/542
D661,149 S *	6/2012	Yang et al. ....	D6/542
D669,718 S *	10/2012	Legreca et al. ....	D6/542

\* cited by examiner

*Primary Examiner* — Brian N Vinson

(74) *Attorney, Agent, or Firm* — Calfee Halter & Griswold LLP

(57) **CLAIM**

I claim the ornamental design a dispenser, as shown and described.

**DESCRIPTION**

FIG. 1 is a rear/right/bottom perspective view of a dispenser; FIG. 2 is a front/left/top perspective view thereof; FIG. 3 is a front elevational view thereof; FIG. 4 is a rear elevational view thereof; FIG. 5 is a right side elevational view thereof; FIG. 6 is a left side elevational view thereof; FIG. 7 is a top plan view thereof; and, FIG. 8 is a bottom plan view thereof. The broken lines in the Figures are for illustrative, environmental purposes only and form no part of the claimed design.

**1 Claim, 5 Drawing Sheets**

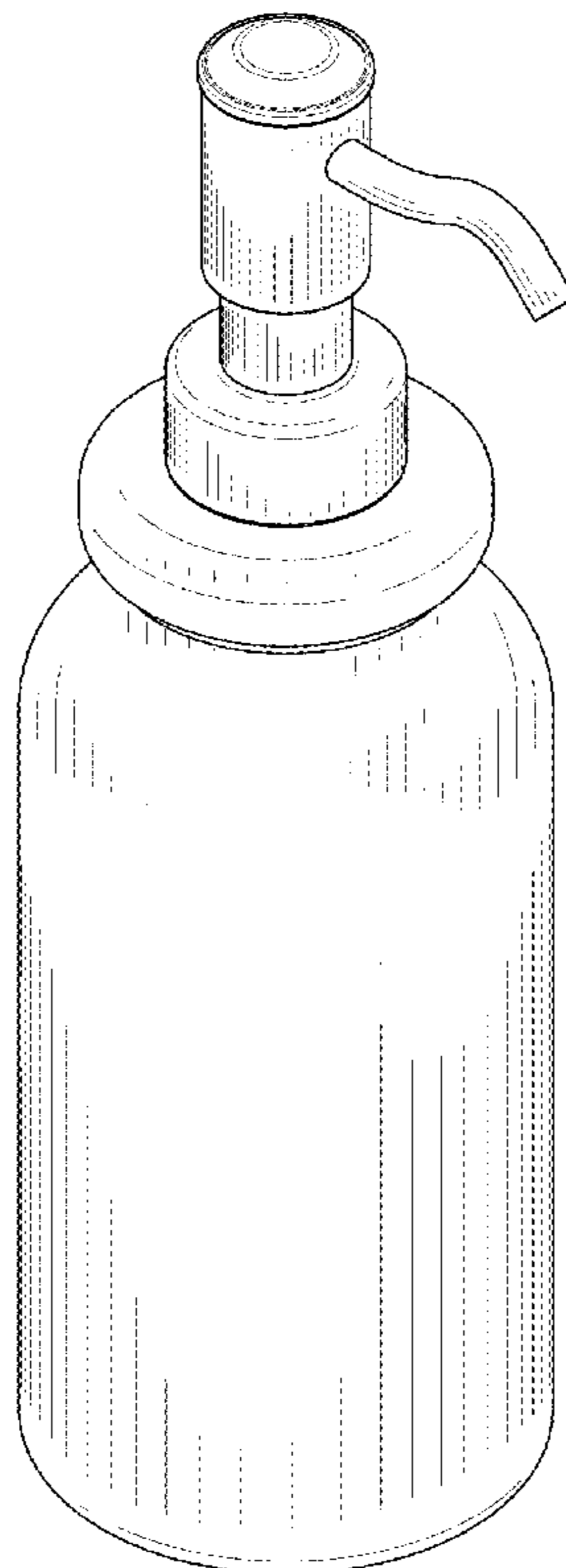

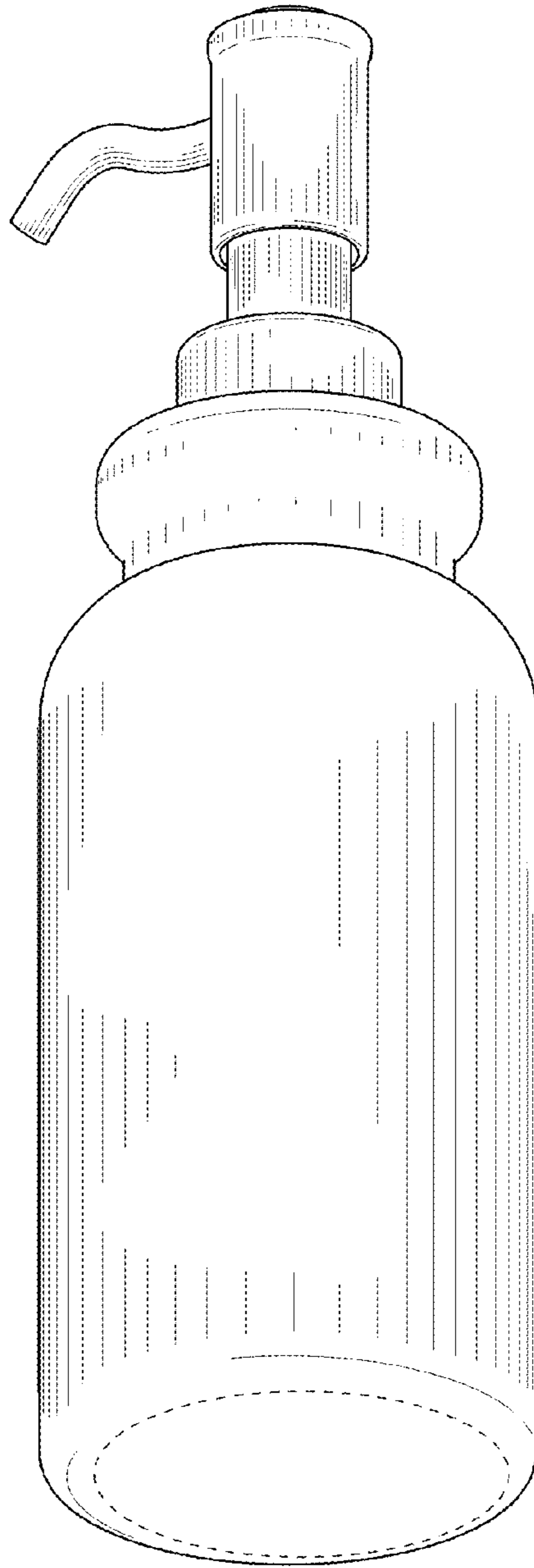

FIG. 1

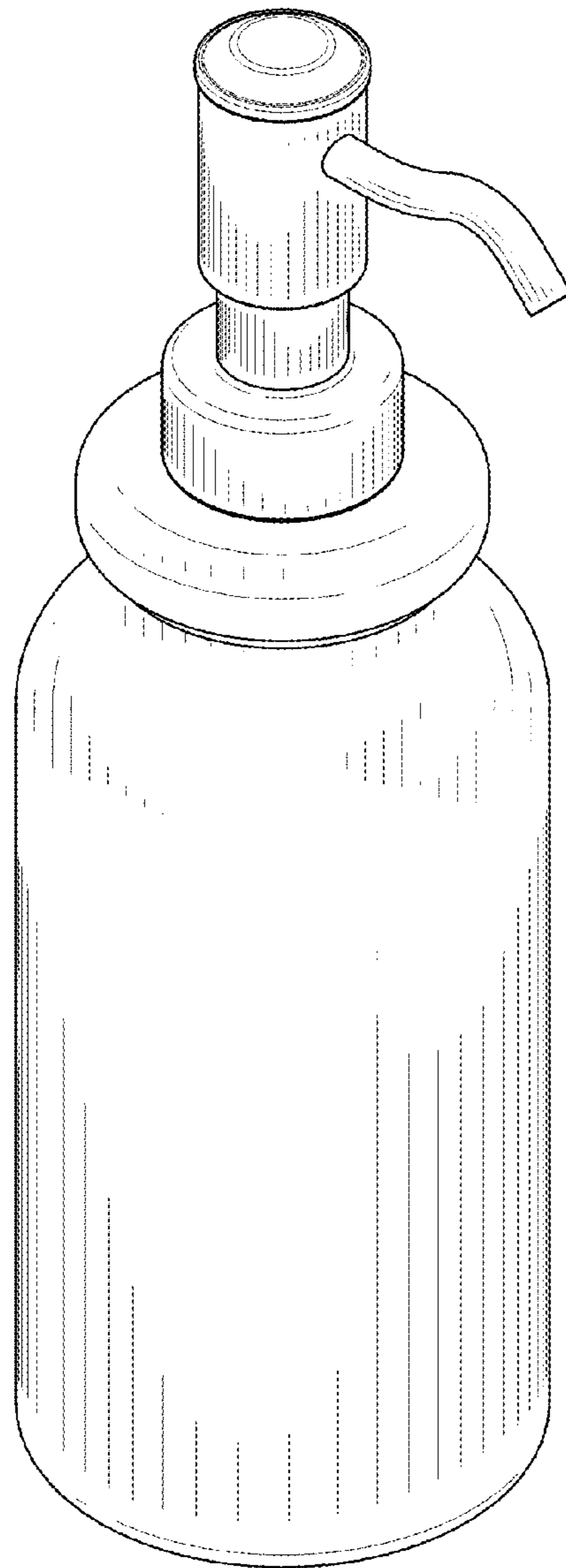

FIG. 2

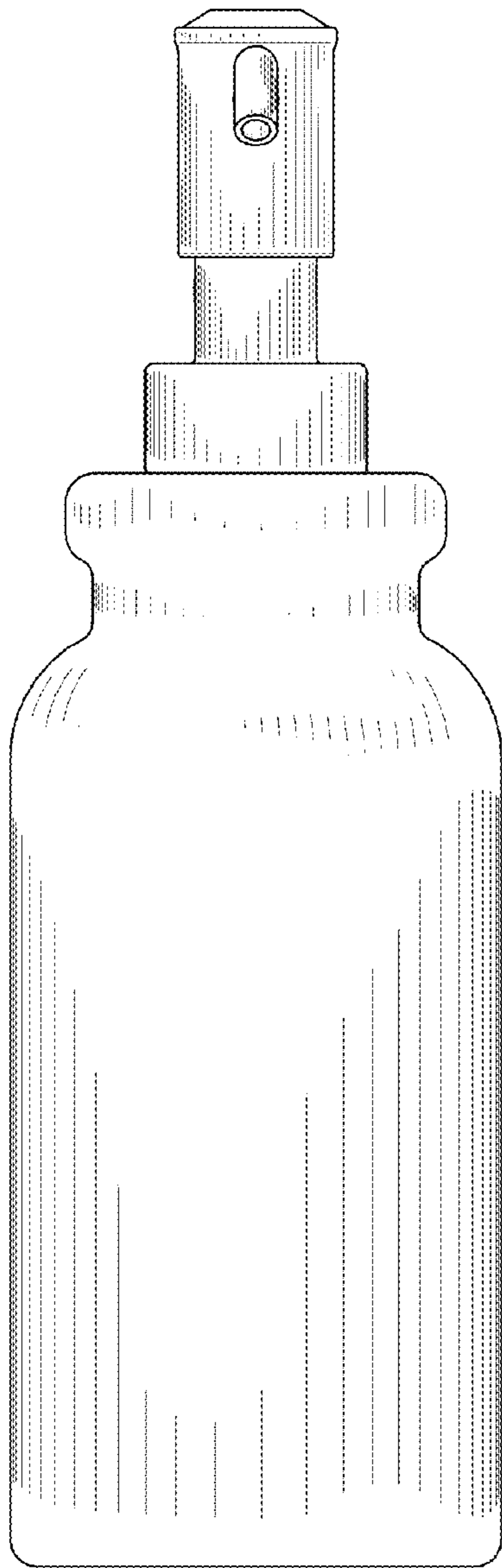

FIG. 3

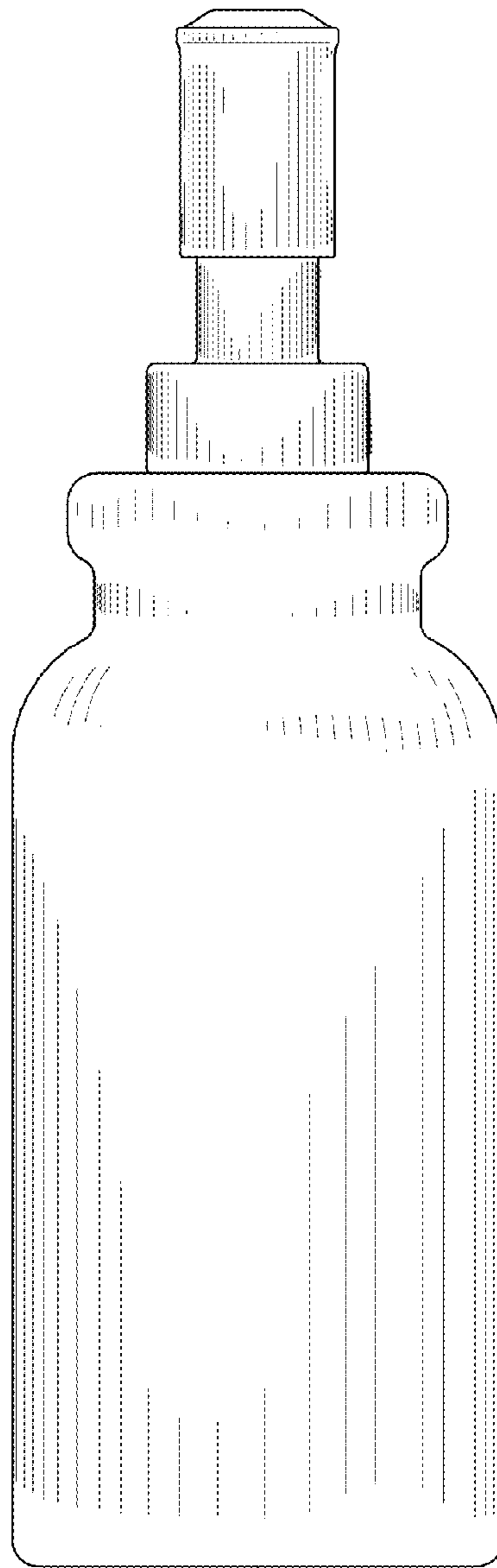

FIG. 4



FIG. 5



FIG. 6

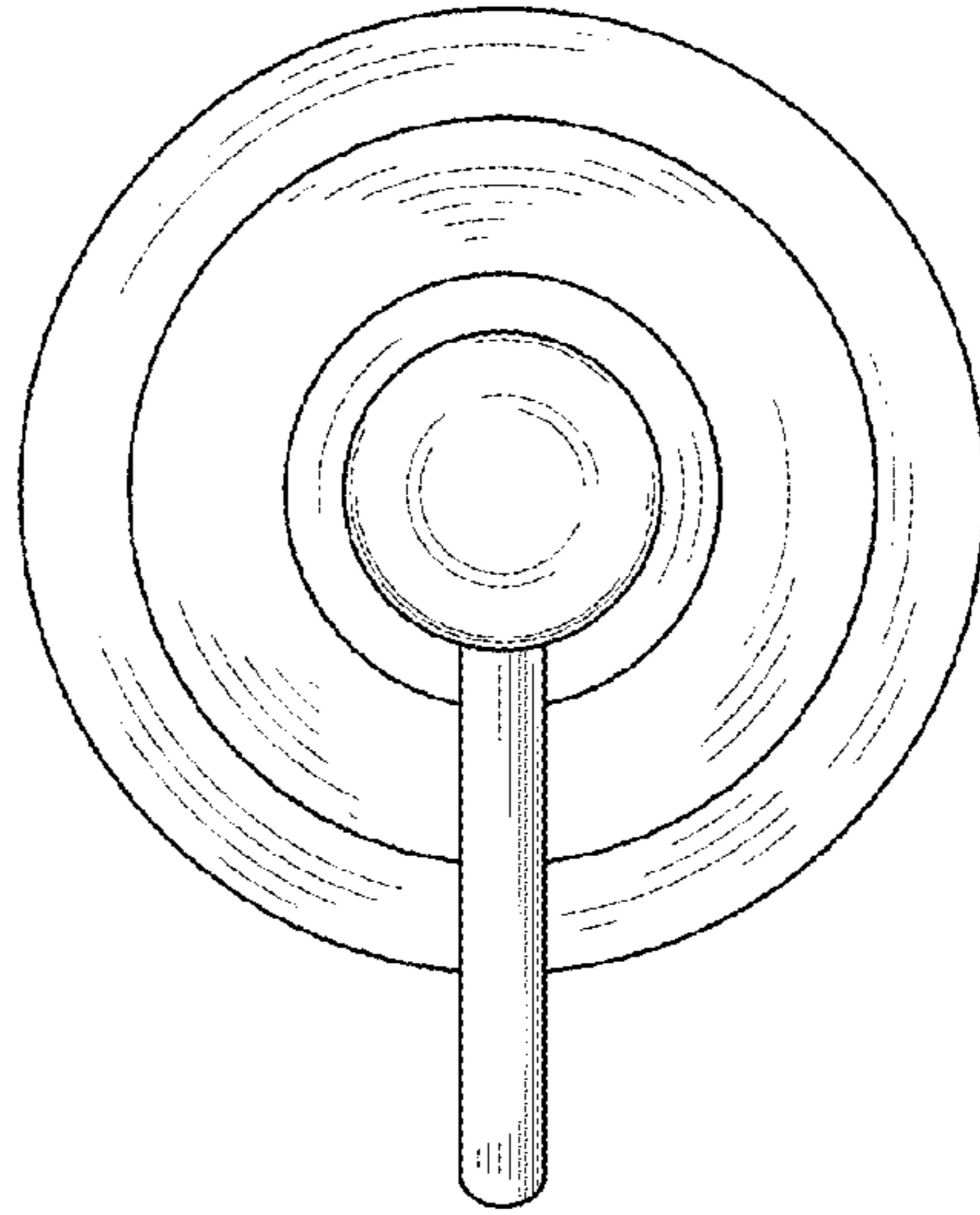

FIG. 7

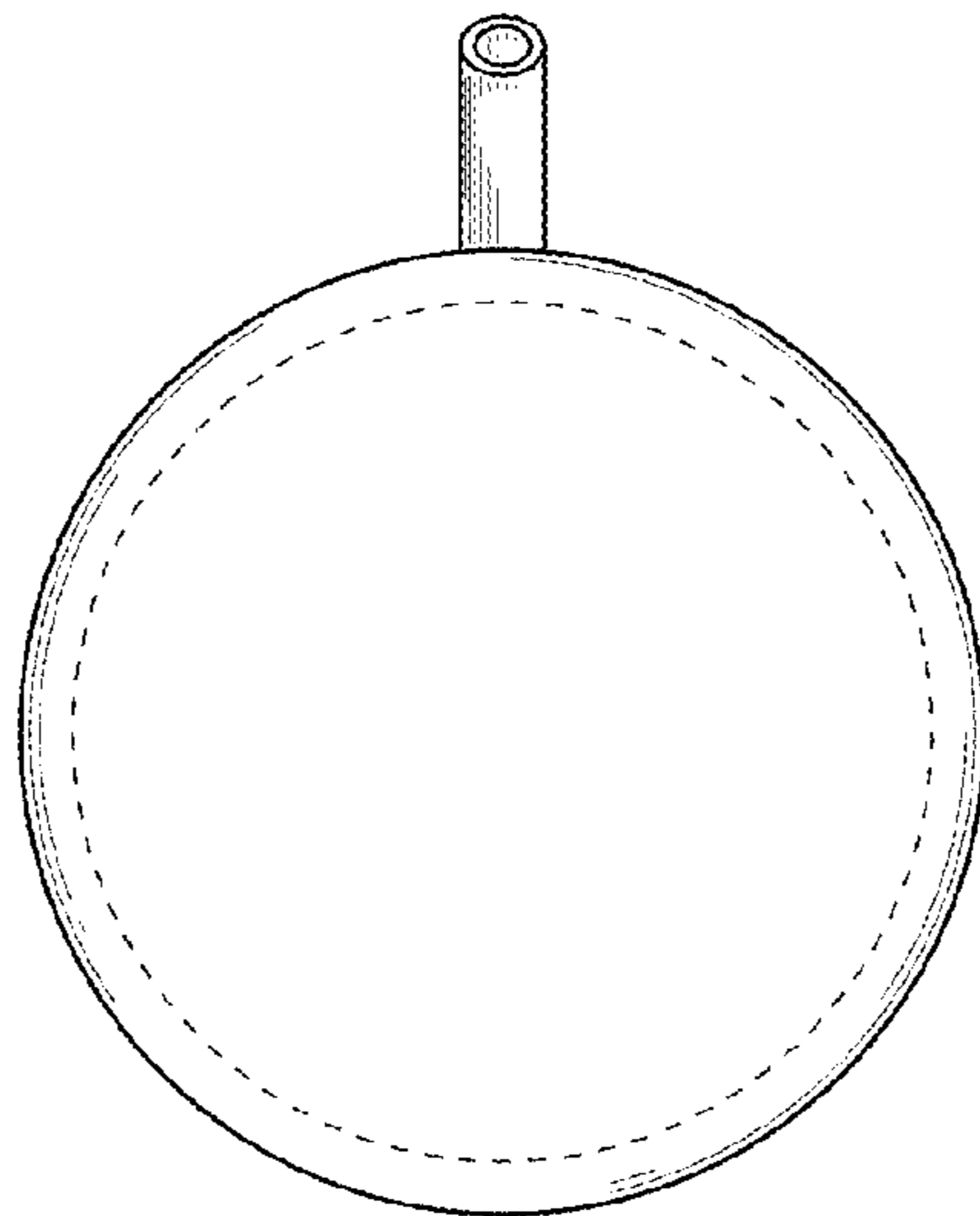

FIG. 8