



US00D713073S

(12) **United States Design Patent**  
**Campbell et al.**

(10) **Patent No.:** **US D713,073 S**

(45) **Date of Patent:** **\*\* Sep. 9, 2014**

(54) **VEHICLE HEADLIGHT**

- (71) Applicant: **Ford Global Technologies, LLC**, Dearborn, MI (US)
- (72) Inventors: **Paul Campbell**, Essex (GB); **Paul Jonathan Alexander Wraith**, Essex (GB); **Simon Spearman-Oxx**, Kent (GB); **Wolfgang Gotschke**, Cologne (DE)

- (\*\*) Term: **14 Years**
- (21) Appl. No.: **29/436,102**
- (22) Filed: **Nov. 1, 2012**

(30) **Foreign Application Priority Data**

- May 4, 2012 (DE) ..... 40 2012 100 342
- (51) **LOC (10) Cl.** ..... **26-06**
- (52) **U.S. Cl.**  
USPC ..... **D26/28**
- (58) **Field of Classification Search**  
USPC ..... D26/28-36; 362/459-468, 475-478,  
362/485-487

See application file for complete search history.

(56) **References Cited**

U.S. PATENT DOCUMENTS

D550,380	S	*	9/2007	Lin	.....	D26/28
D560,291	S	*	1/2008	Koyama	.....	D26/28
D560,832	S	*	1/2008	Hsu	.....	D26/28
D561,358	S	*	2/2008	Tachibana	.....	D26/28
D561,359	S	*	2/2008	Hsu	.....	D26/28
D563,576	S	*	3/2008	Hanaoka	.....	D26/28
D569,533	S	*	5/2008	Hsu	.....	D26/28
D570,007	S	*	5/2008	Hsu	.....	D26/28
D593,232	S	*	5/2009	Koman et al.	.....	D26/28

OTHER PUBLICATIONS

- Now on Jokeforblog, May 12, 2012 <http://jokeforblog.blogspot.com/2012/05/ford-transit-connect-leaked.html>.
- Garage Car 2013 Ford Transit Shows the new generation Tourneo Custom Concept, Mar. 7, 2012 <http://nashvillestories.blogspot.com/2012/03/2013-ford-transit-shows-new-generation.html>.
- Ford Unveils All-New 2014 Transit, Transit Connect, Transit Courier Vans, Sep. 6, 2012 <http://rumors.automobilemag.com/ford-unveils-all-new-2013-transit-connect-for-europe-167369.html#axzz2KbpT6e2s>.
- CarAdvice Ford Transit Custom previews new commercial van range, Apr. 19, 2012 <http://www.caradvice.com.au/168987/ford-transit-custom-previews-new-commercial-van-range/ford-transit-custom-concept-4>.
- Ford Tourneo Custom Concept previews next-gen Transit range, Feb. 22, 2012 <http://www.gizmag.com/ford-tourneo-transit-private-commercial-van/21554/>.

\* cited by examiner

*Primary Examiner* — Marcus Jackson  
(74) *Attorney, Agent, or Firm* — Damian Porcari

(57) **CLAIM**

The ornamental design for a vehicle headlight, shown and described.

**DESCRIPTION**

FIG. 1 is a left side elevational view of a left vehicle headlight (the right vehicle headlight being a mirror image and is not shown);

FIG. 2 is right side elevational view of the vehicle headlight;

FIG. 3 is a front elevational view of the vehicle headlight;

FIG. 4 is a top plan view of the vehicle headlight;

FIG. 5 is a bottom plan view of the vehicle headlight;

FIG. 6 is a perspective view of the vehicle headlight; and,

FIG. 7 is another perspective view of the vehicle headlight.

**1 Claim, 7 Drawing Sheets**

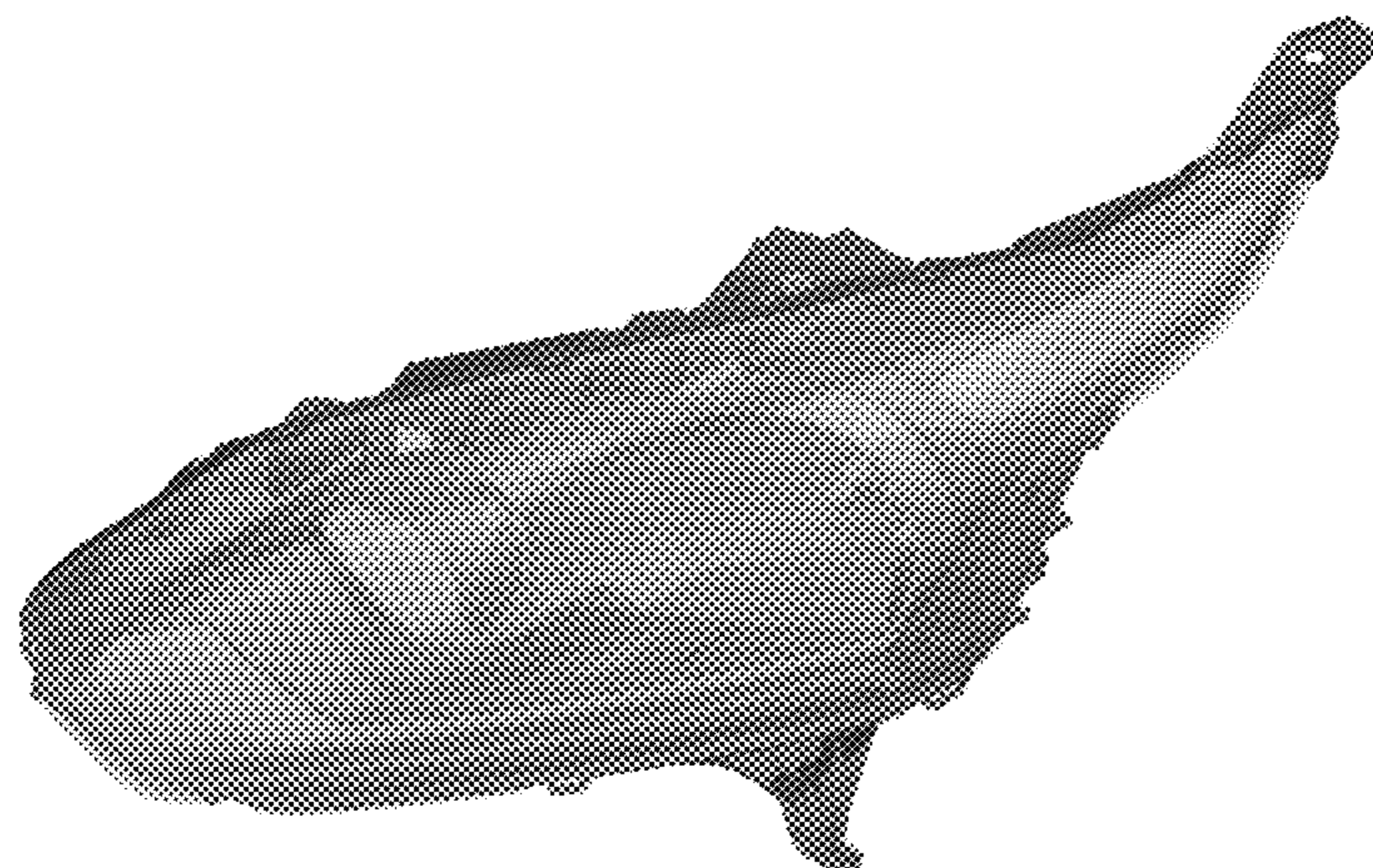

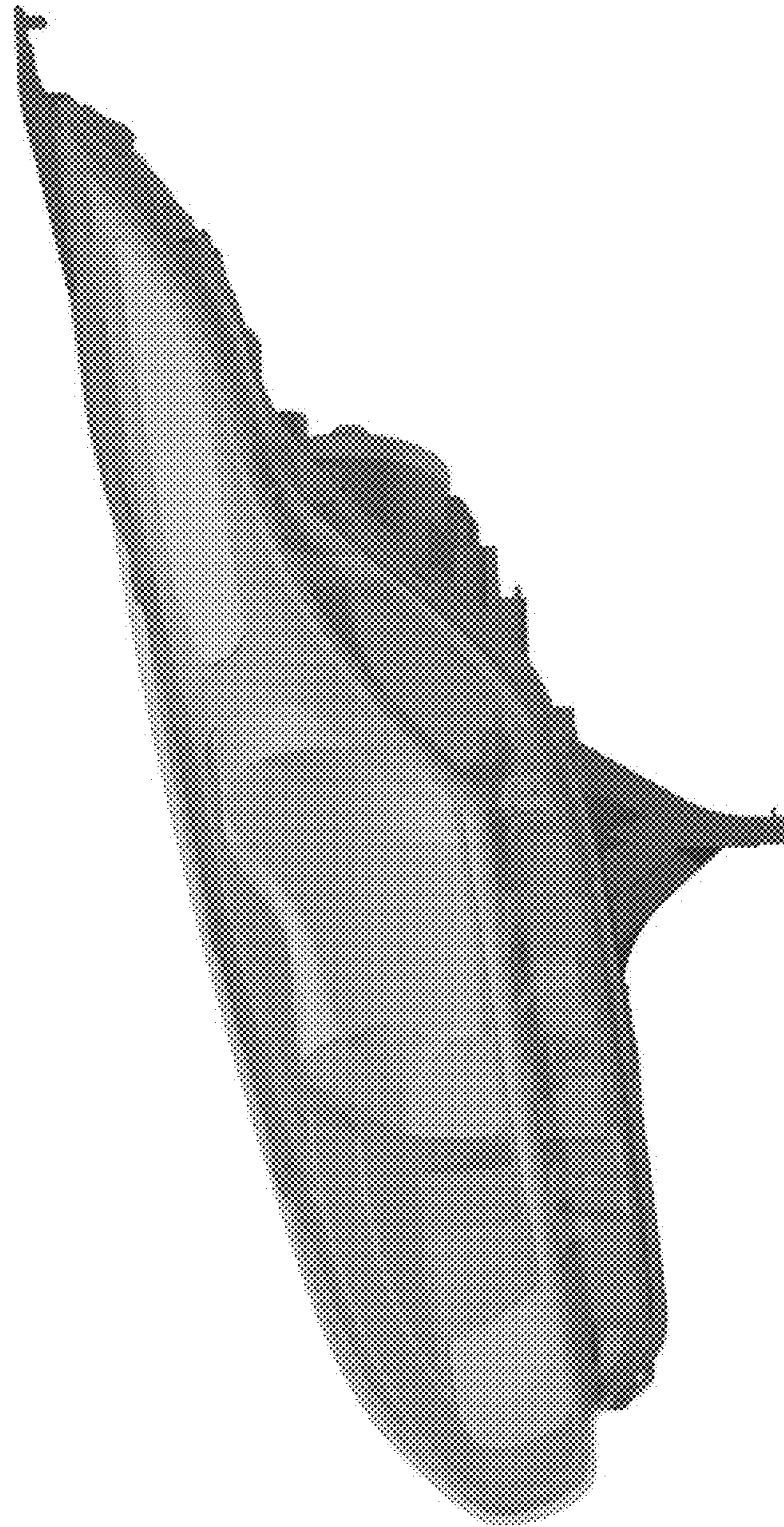

Figure 1



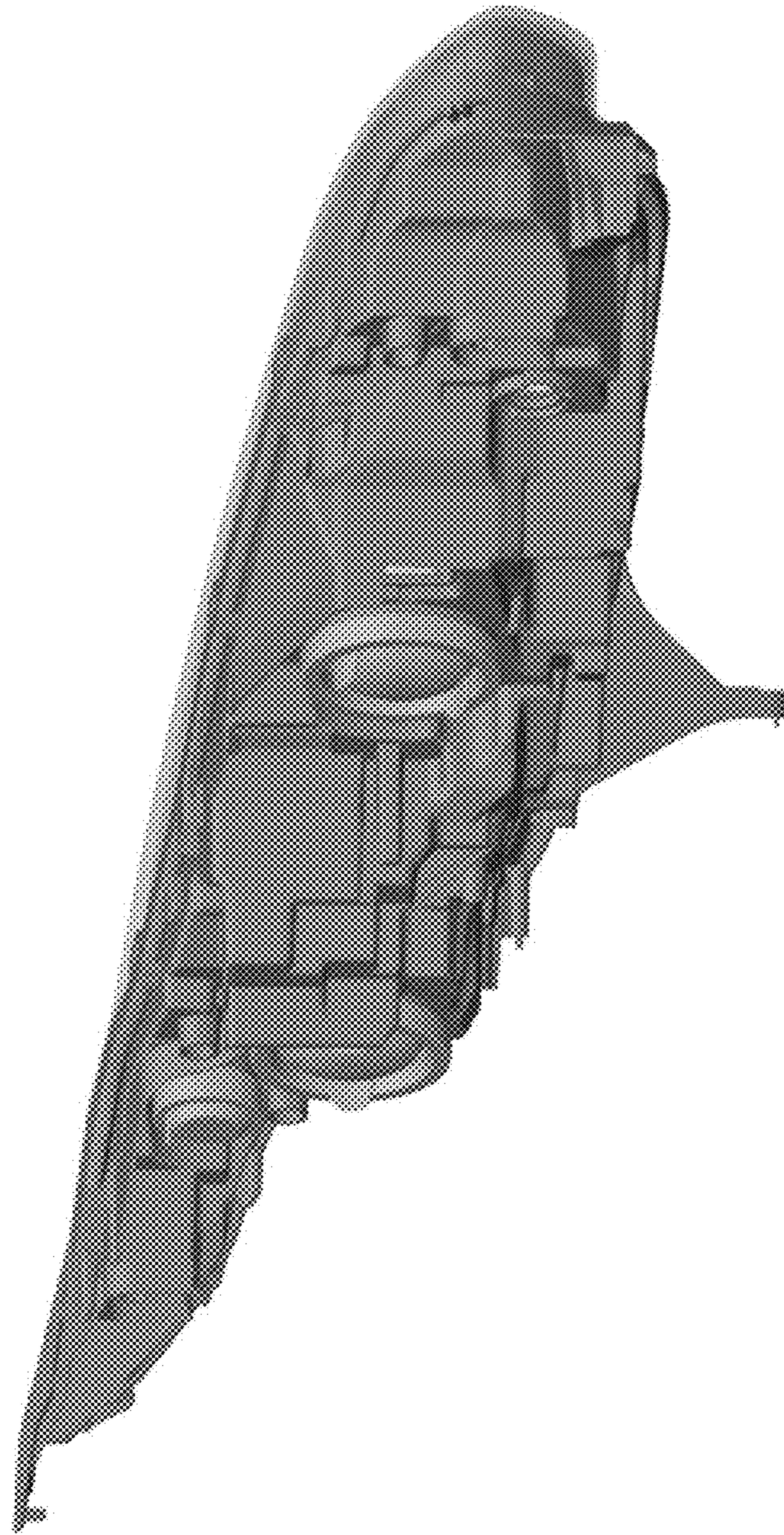

Figure 2

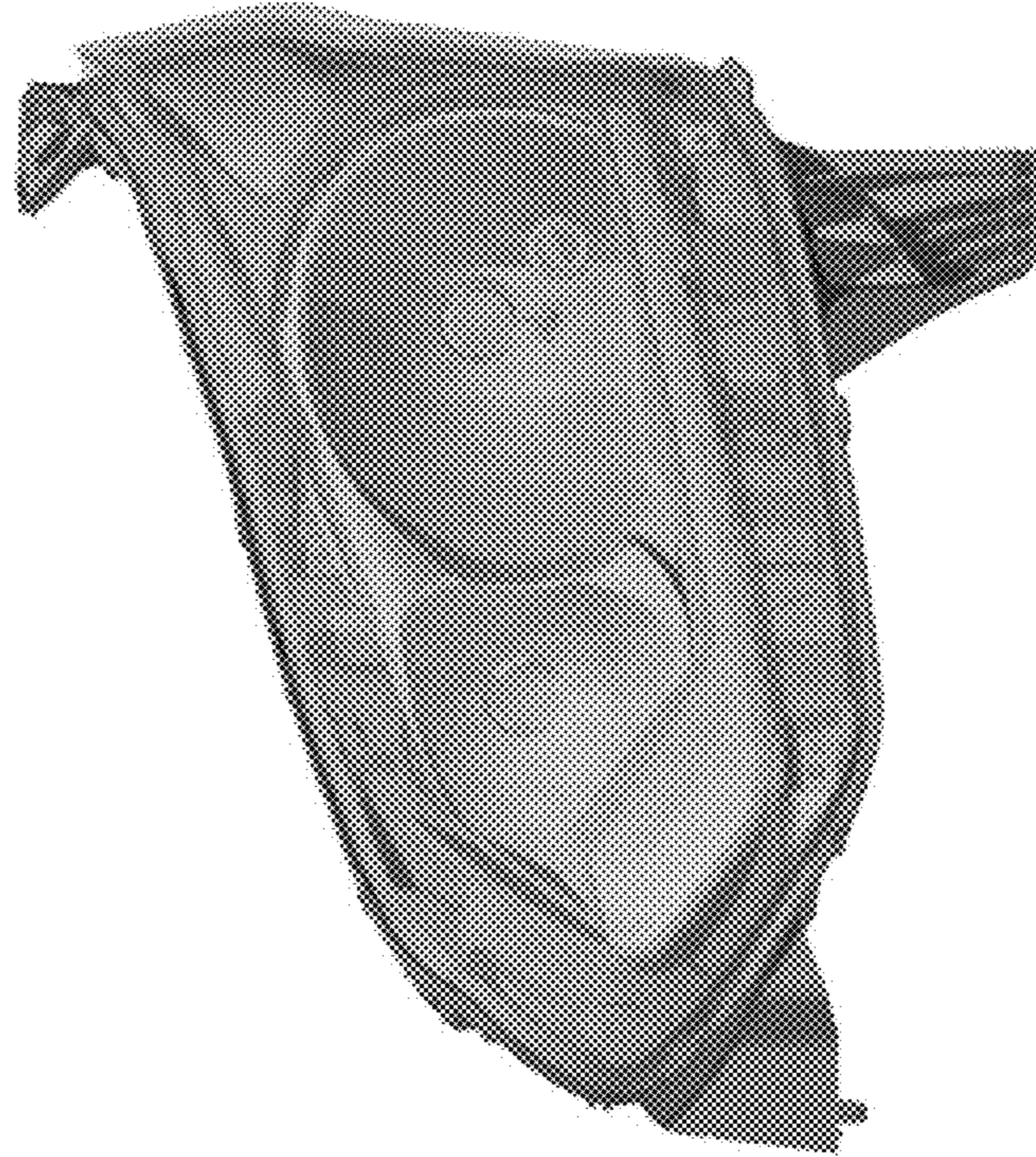

Figure 3



Figure 4

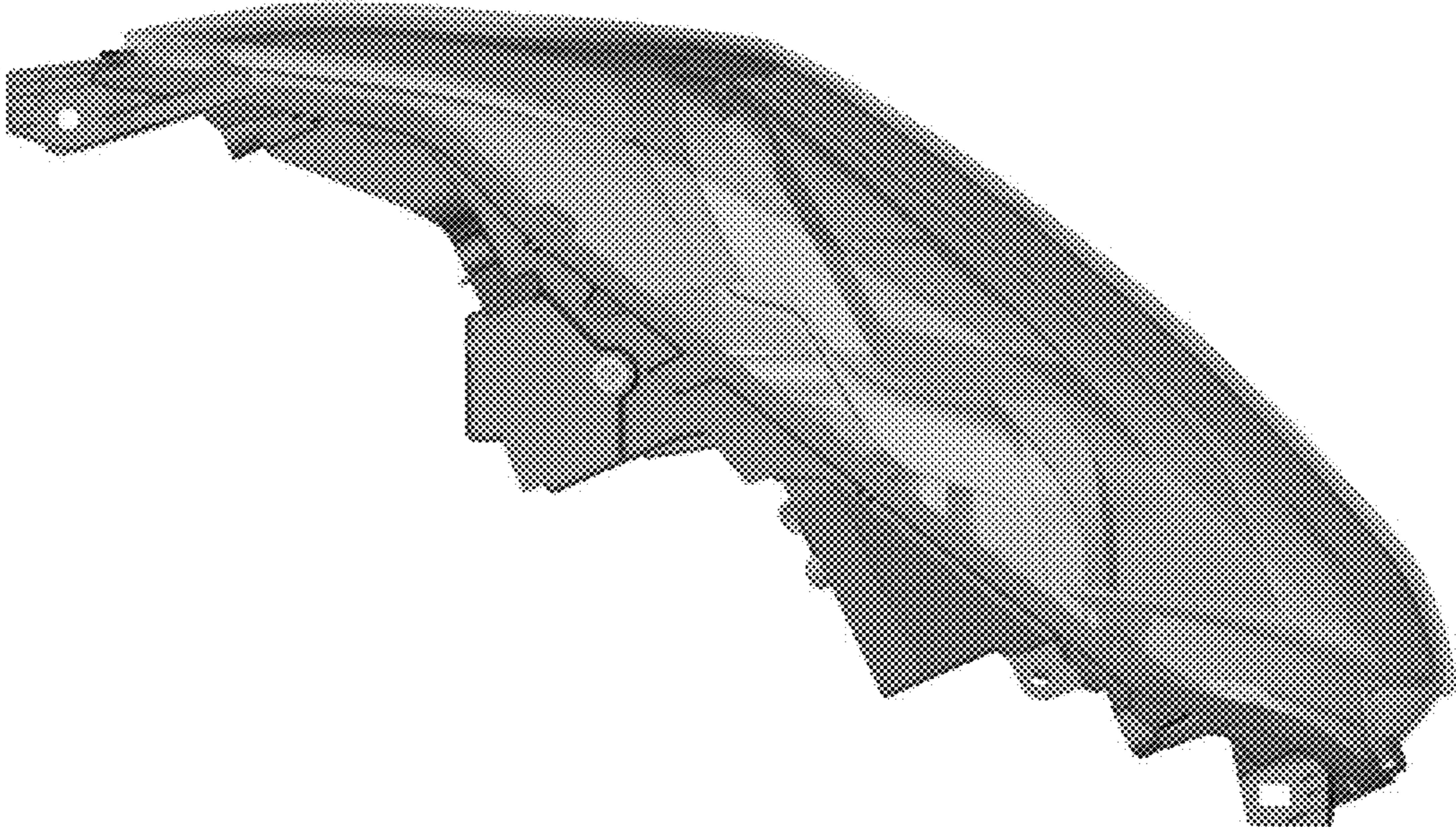
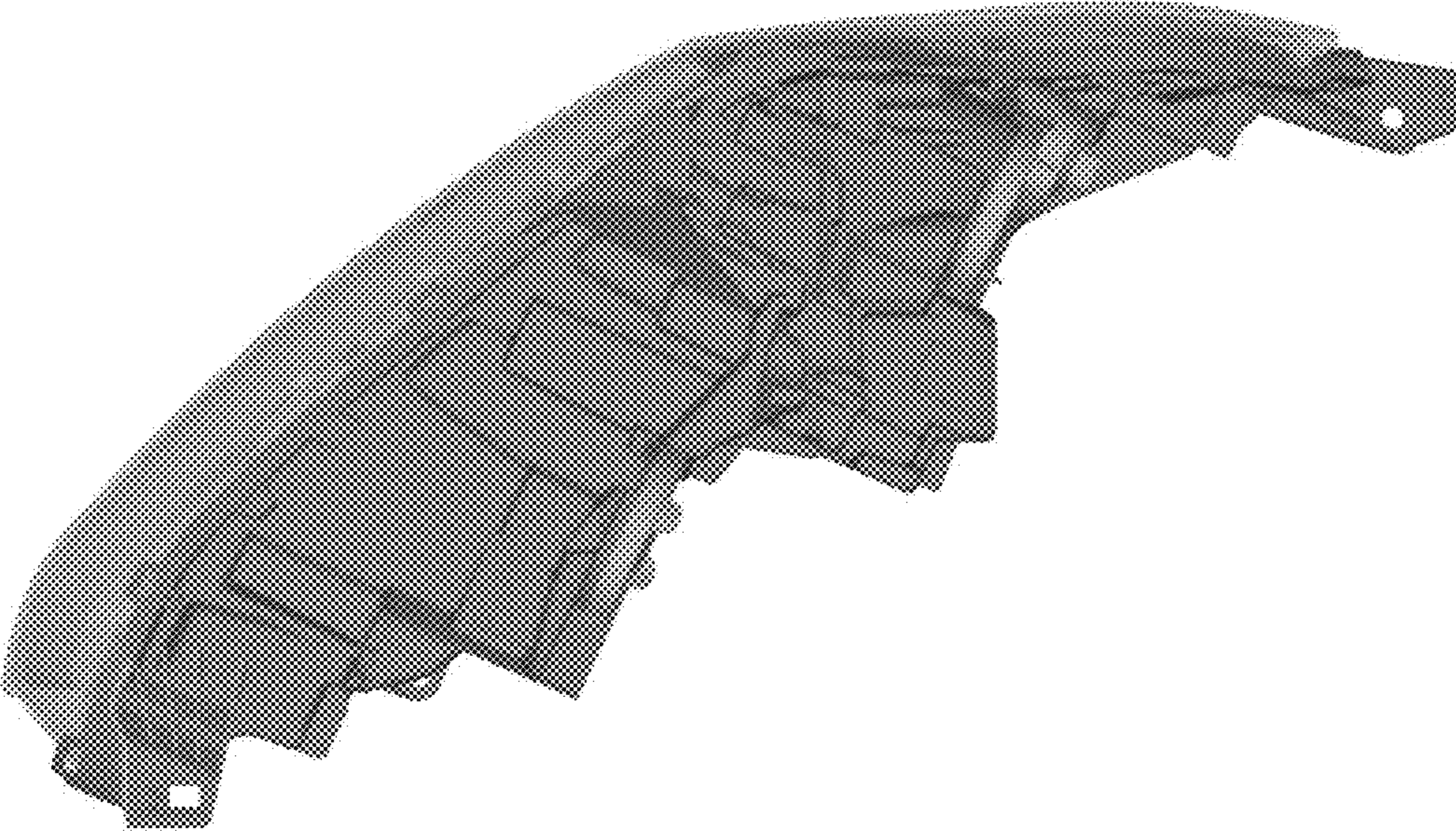

Figure 5





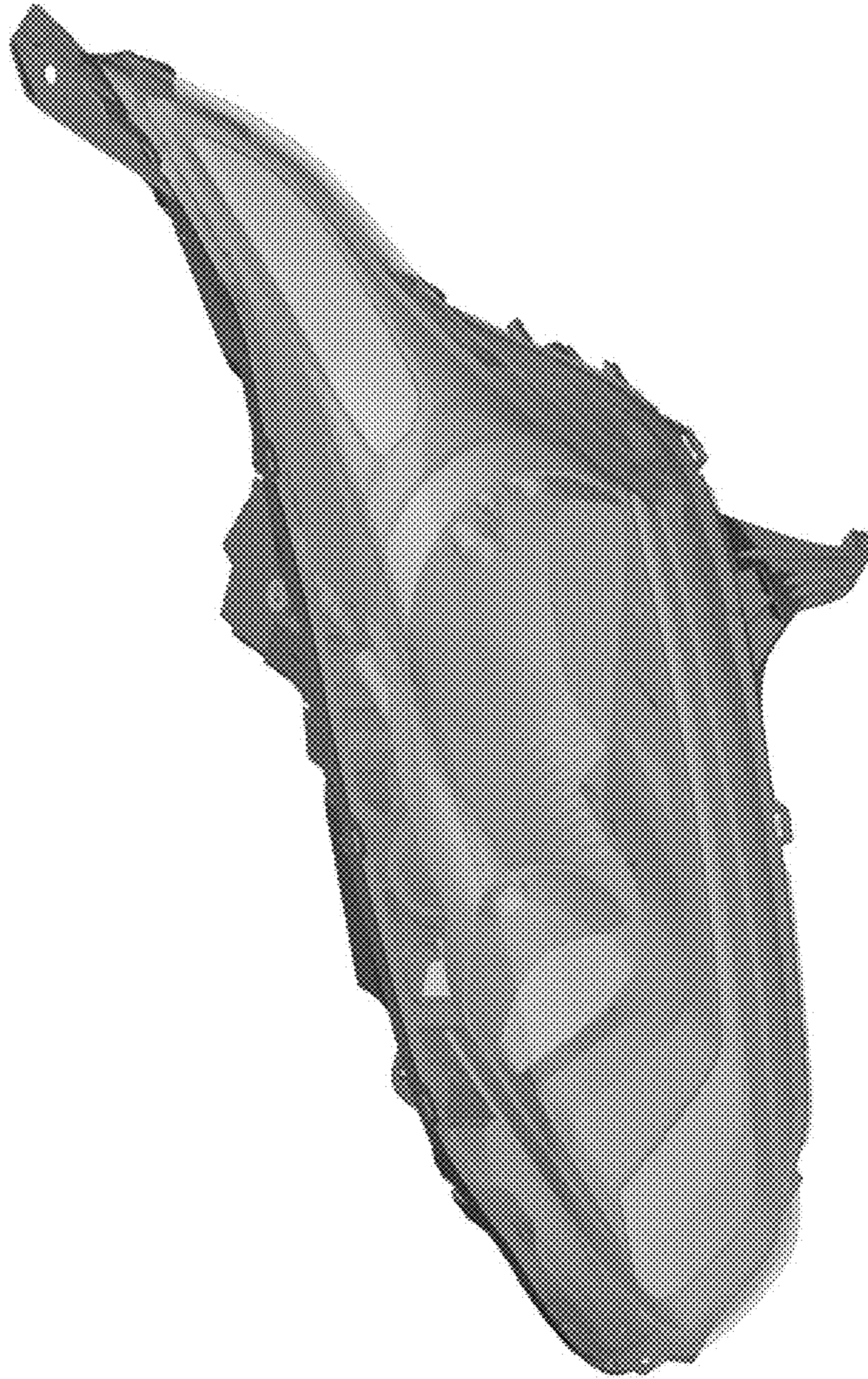

Figure 6

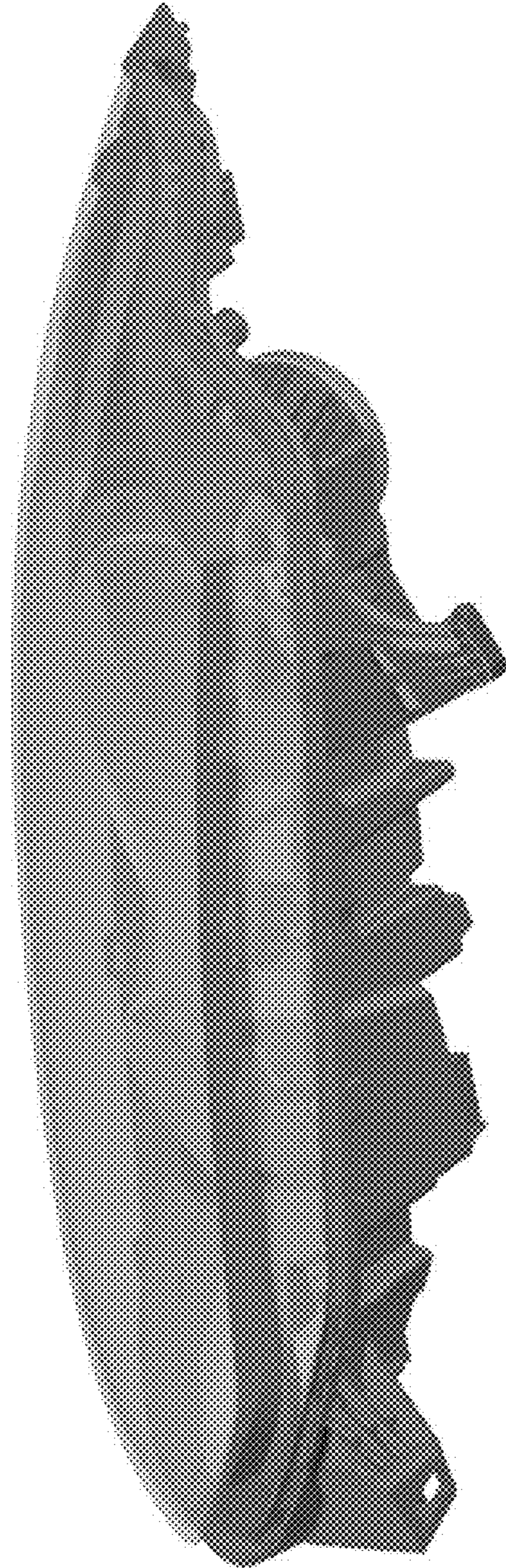

Figure 7