



US00D713071S

(12) **United States Design Patent**
Namai et al.

(10) **Patent No.:** **US D713,071 S**
(45) **Date of Patent:** **** Sep. 9, 2014**

(54) **REAR COMBINATION LAMP FOR A MOTOR SCOOTER**

D601,728 S * 10/2009 Kogo et al. D26/28
D605,793 S * 12/2009 Weil D26/28
D617,021 S * 6/2010 Ishiguri et al. D26/28

(75) Inventors: **Masashi Namai**, Saitama-ken (JP);
Yoshitaka Kubota, Saitama-ken (JP);
Maurizio Carbonara, Rome (IT)

* cited by examiner

(73) Assignee: **Honda Motor Co., Ltd.**, Tokyo (JP)

Primary Examiner — Marcus Jackson
(74) *Attorney, Agent, or Firm* — Westerman, Hattori,
Daniels & Adrian, LLP

(**) Term: **14 Years**

(57) **CLAIM**

(21) Appl. No.: **29/425,448**

The ornamental design for a rear combination lamp for a motor scooter, as shown and described.

(22) Filed: **Jun. 22, 2012**

DESCRIPTION

(30) **Foreign Application Priority Data**

Dec. 28, 2011 (JP) 2011-030574

(51) **LOC (10) Cl.** **26-06**

(52) **U.S. Cl.**
USPC **D26/28**

(58) **Field of Classification Search**
USPC D26/28-36; 362/459-468, 475-478,
362/485-487

See application file for complete search history.

FIG. 1 is a perspective view from the front side of a rear combination lamp for a motor scooter.
FIG. 2 is a perspective view from the front side thereof.
FIG. 3 is a perspective view from the rear side thereof.
FIG. 4 is a perspective view from the rear side thereof.
FIG. 5 is a front elevation view thereof.
FIG. 6 is a rear elevation view thereof.
FIG. 7 is a top plan view thereof.
FIG. 8 is a bottom plan view thereof.
FIG. 9 is a right side elevation view thereof; and,
FIG. 10 is a left side elevation view thereof.
The portions of the rear combination lamp shown in broken lines are for the purpose of showing environmental structure only and form no part of the claimed design.

(56) **References Cited**

U.S. PATENT DOCUMENTS

D596,767 S * 7/2009 Idei D26/28
D600,374 S * 9/2009 Brew et al. D26/28

1 Claim, 10 Drawing Sheets

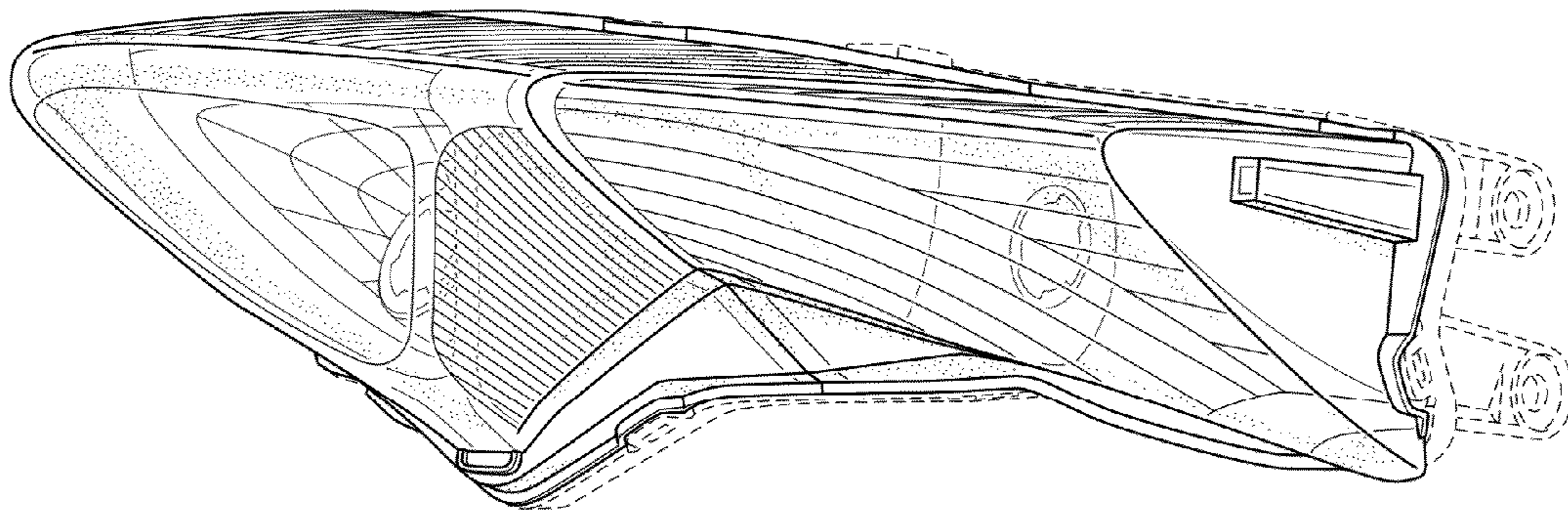

FIG. 1

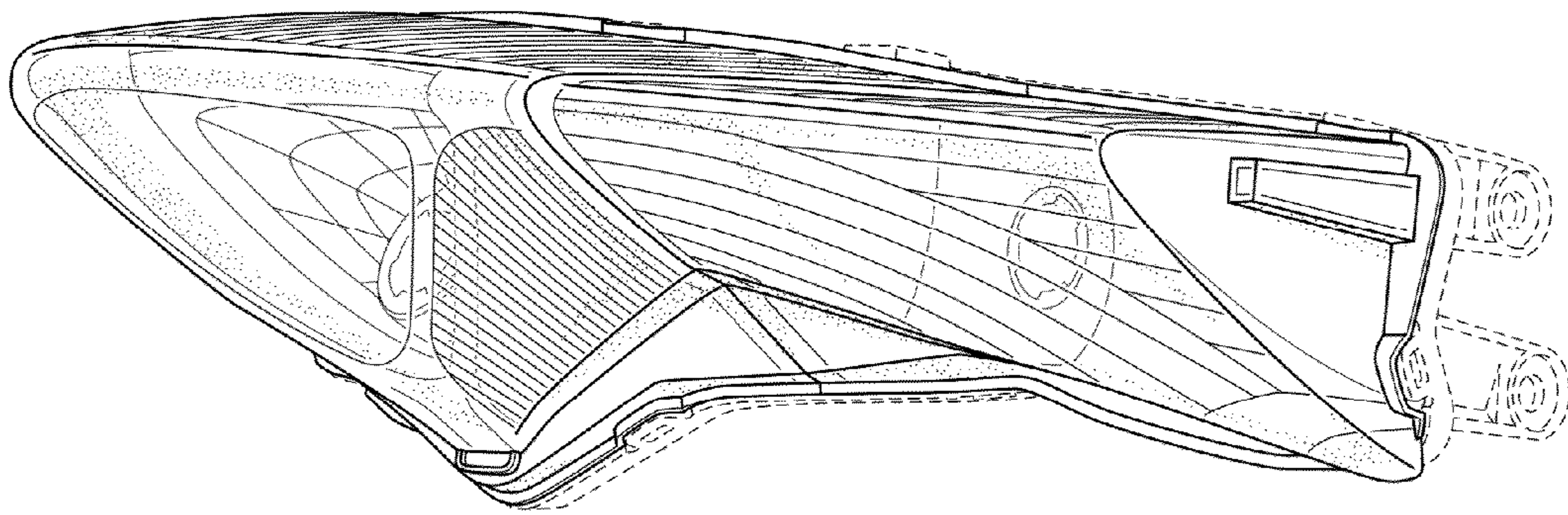

FIG. 2

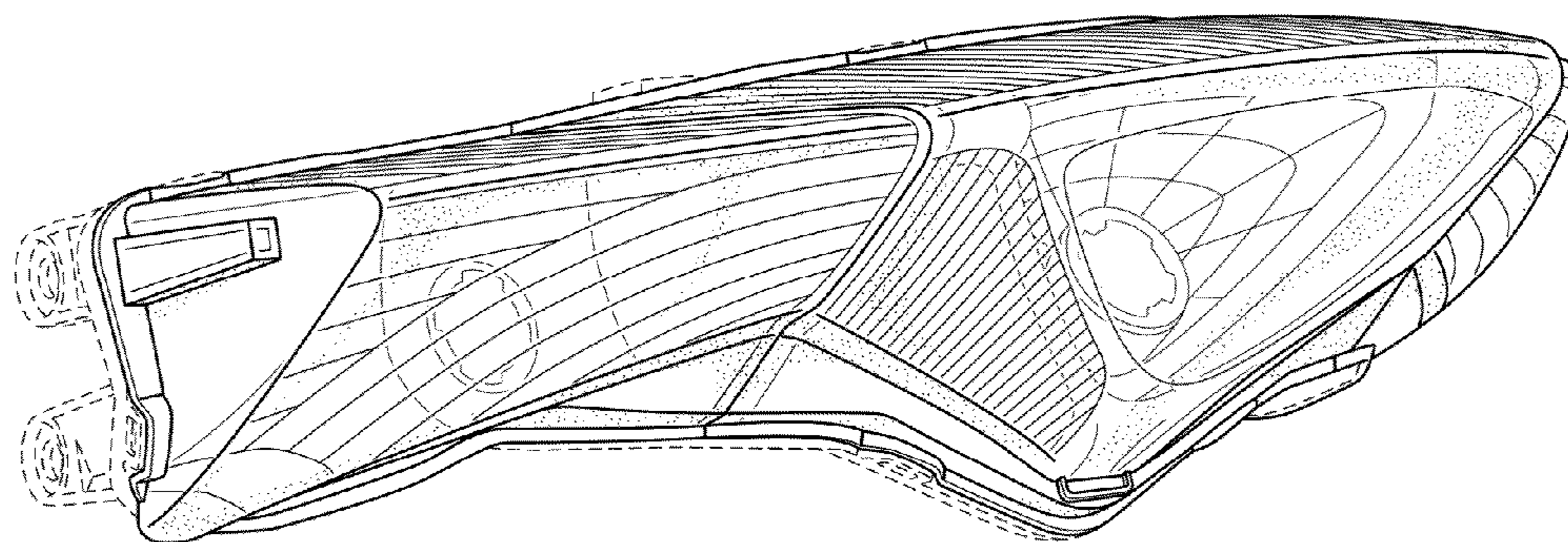

FIG. 3

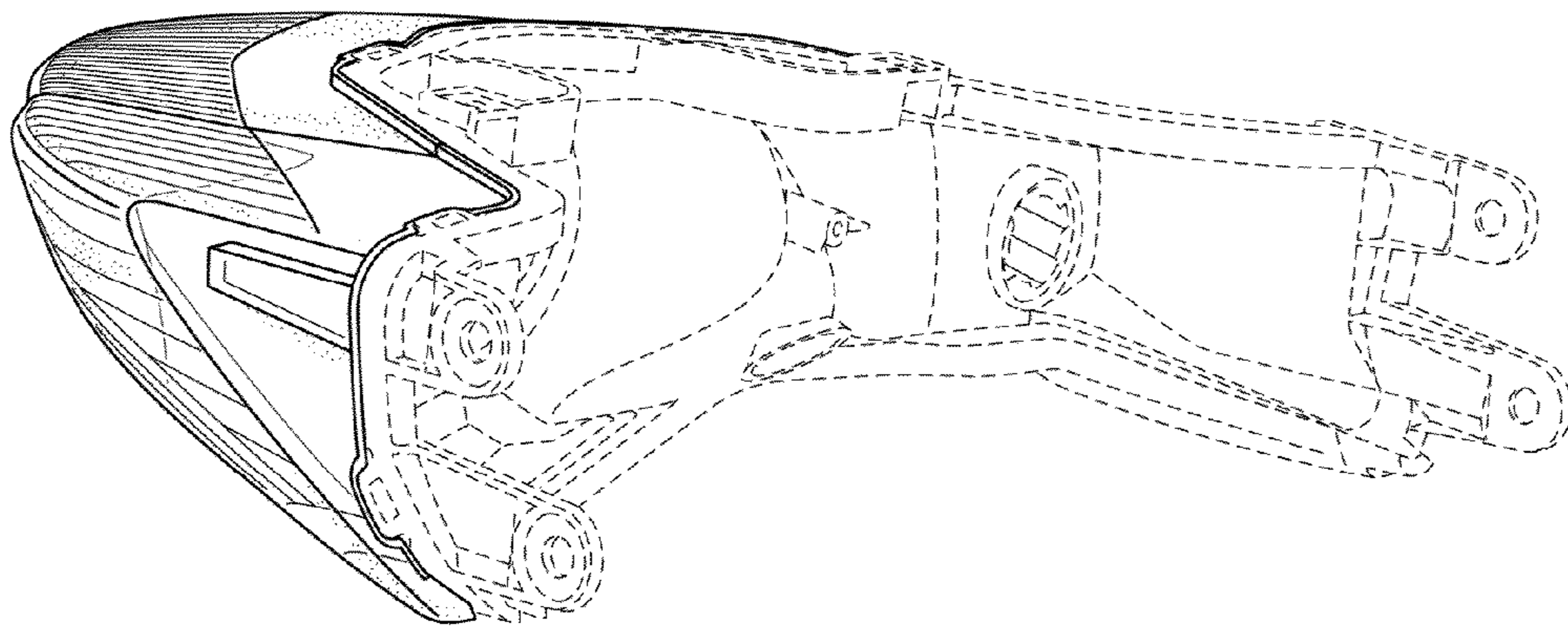

FIG. 4

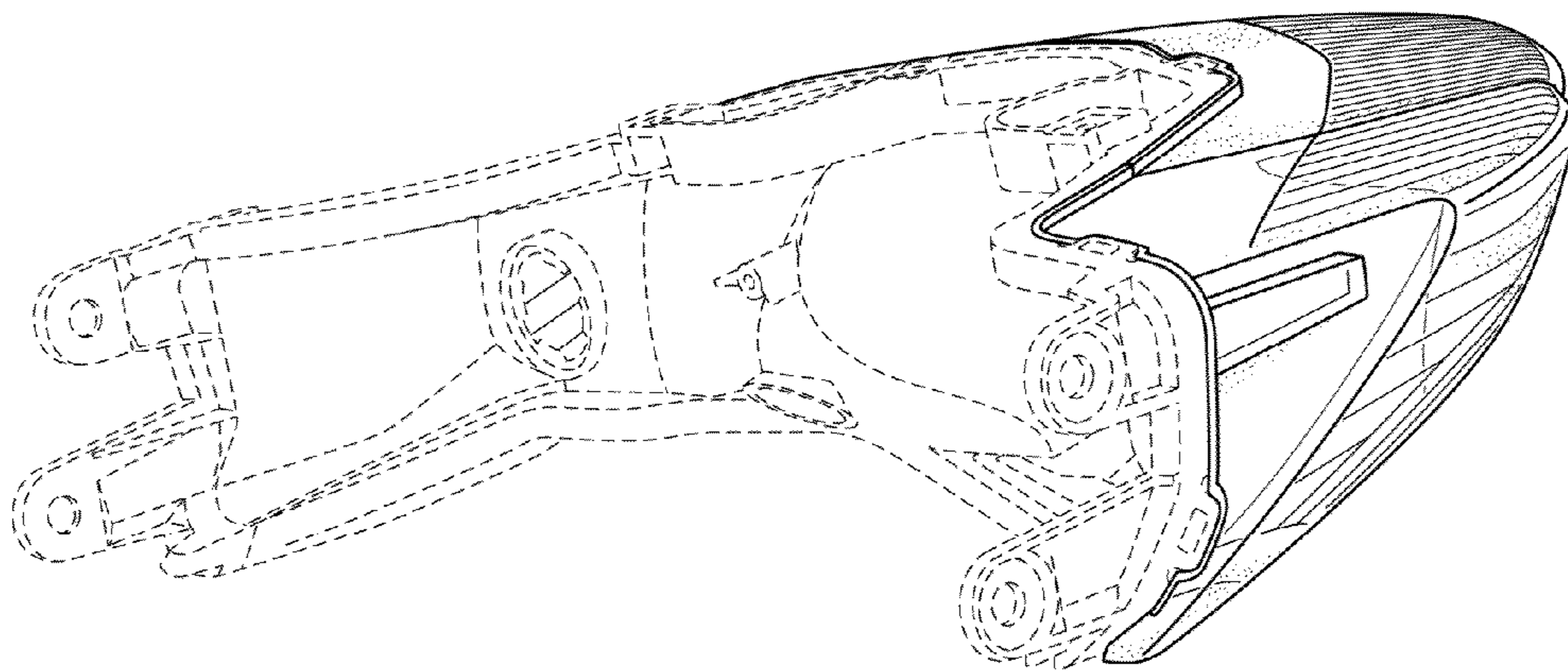

FIG. 5

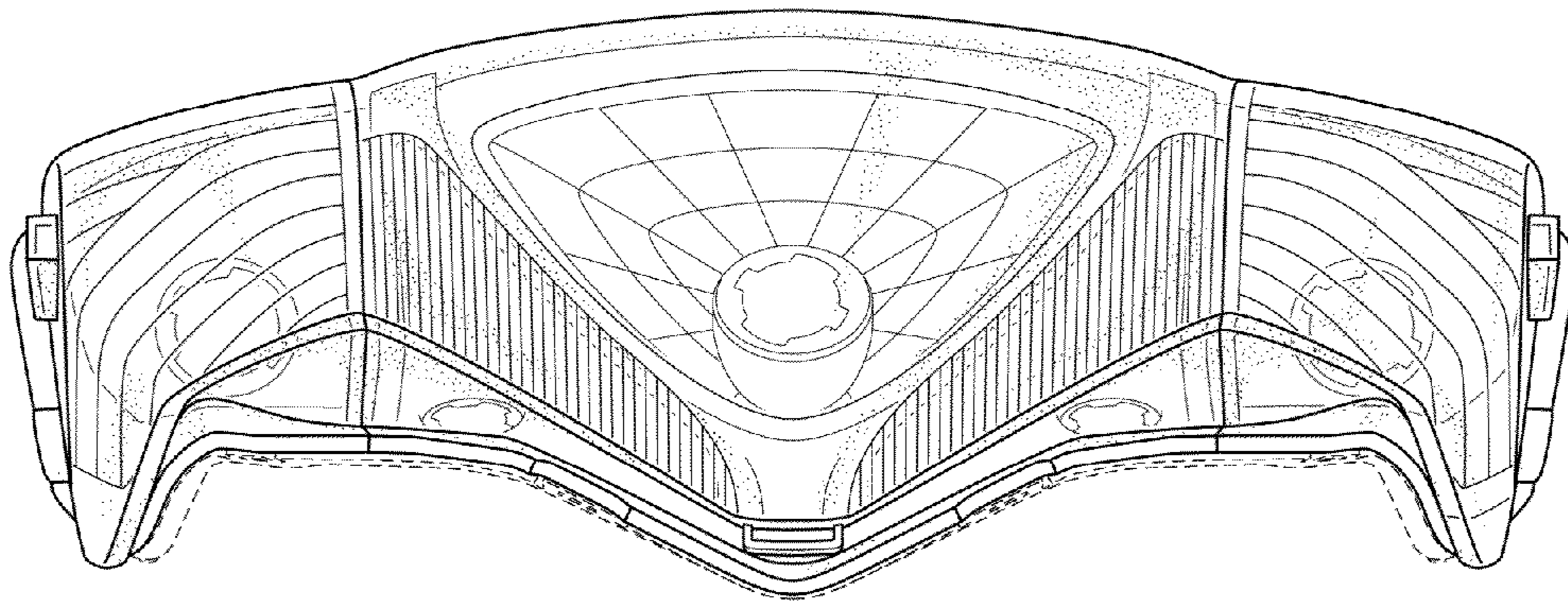

FIG. 6

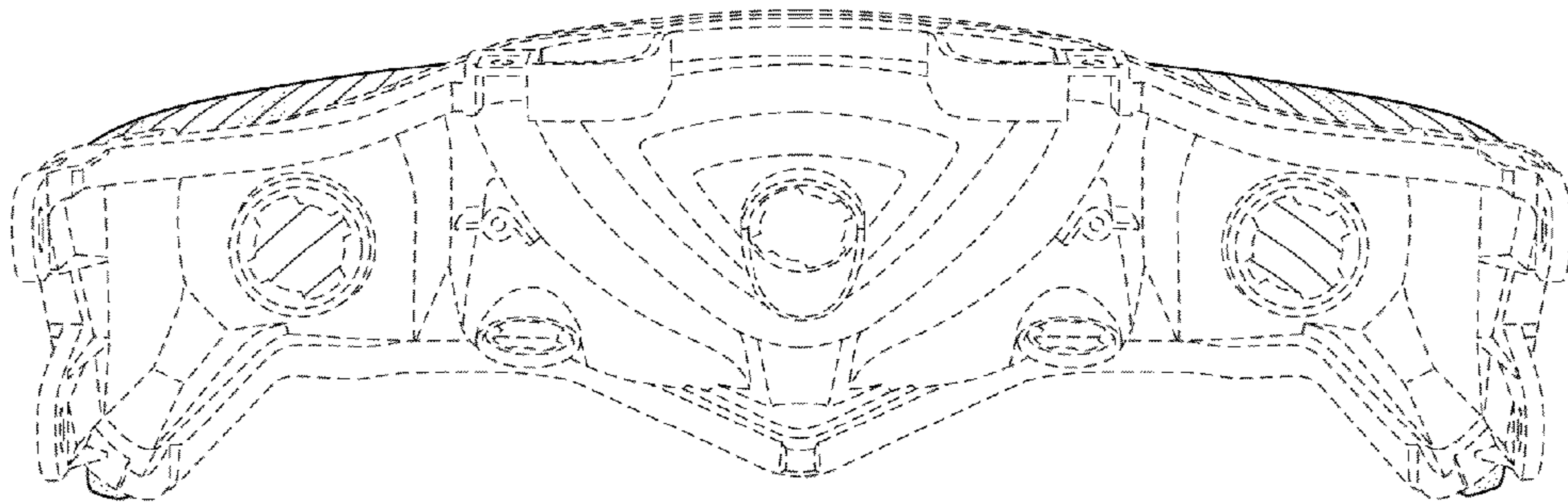

FIG. 7

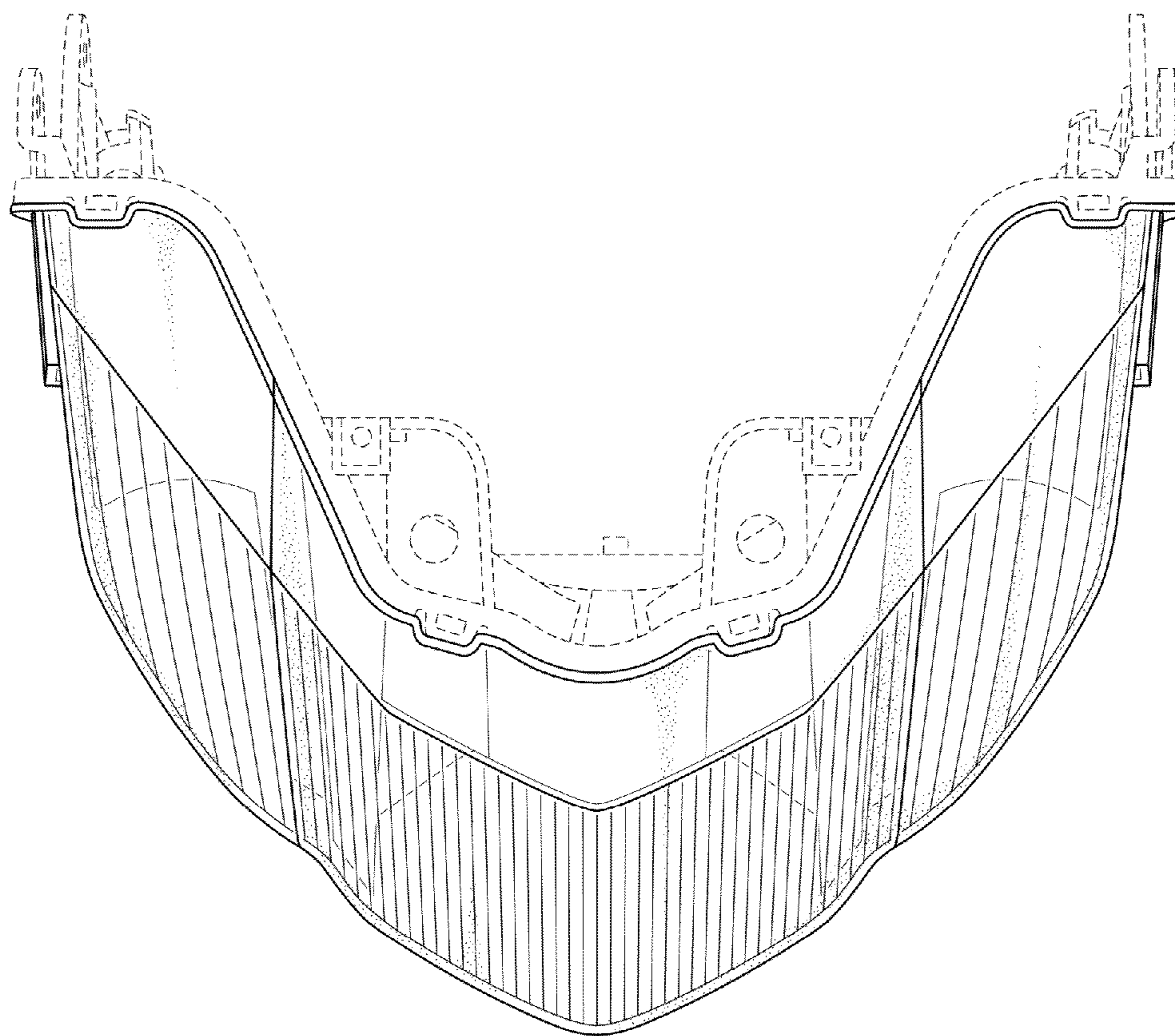

FIG. 8

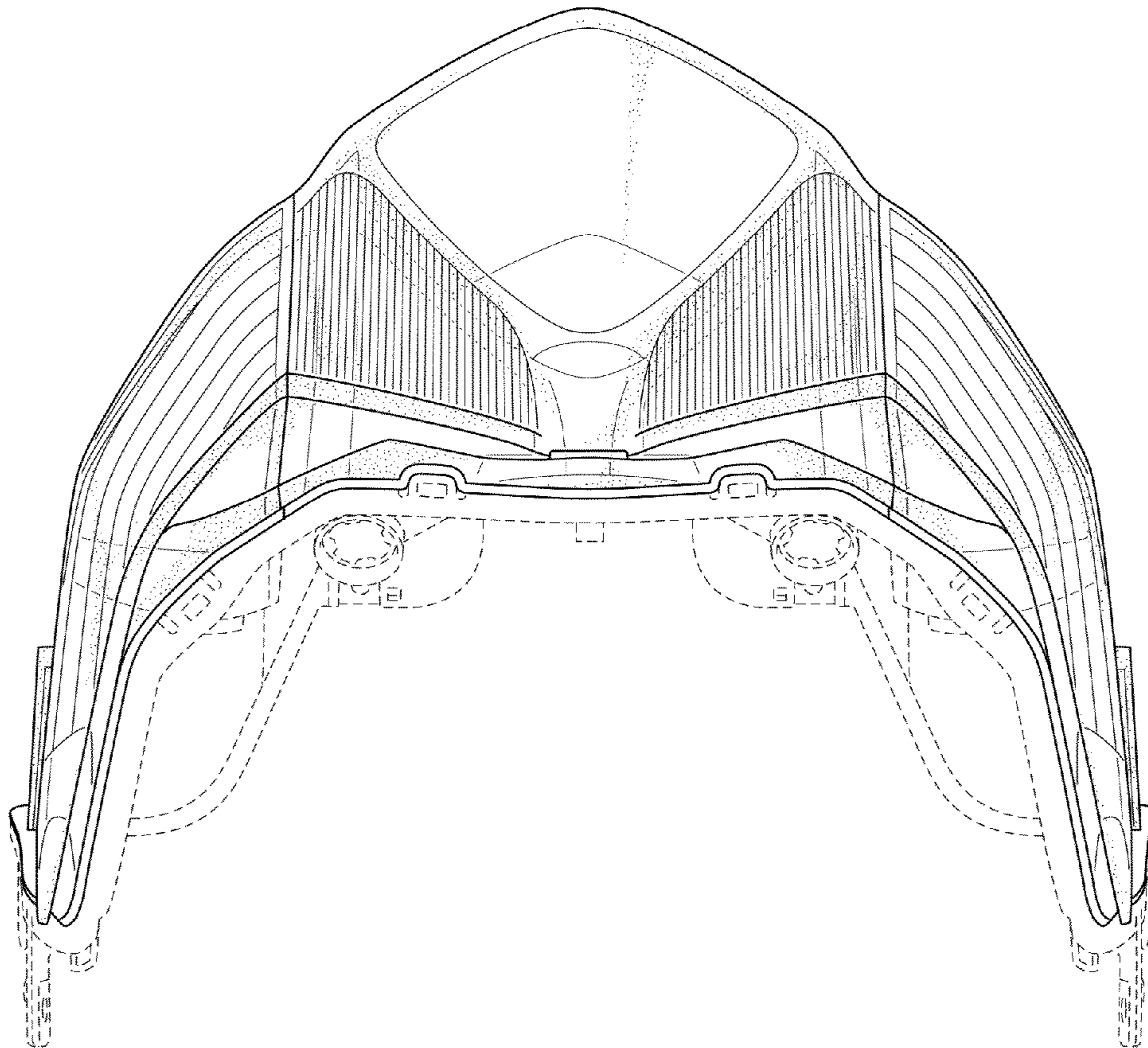

FIG. 9

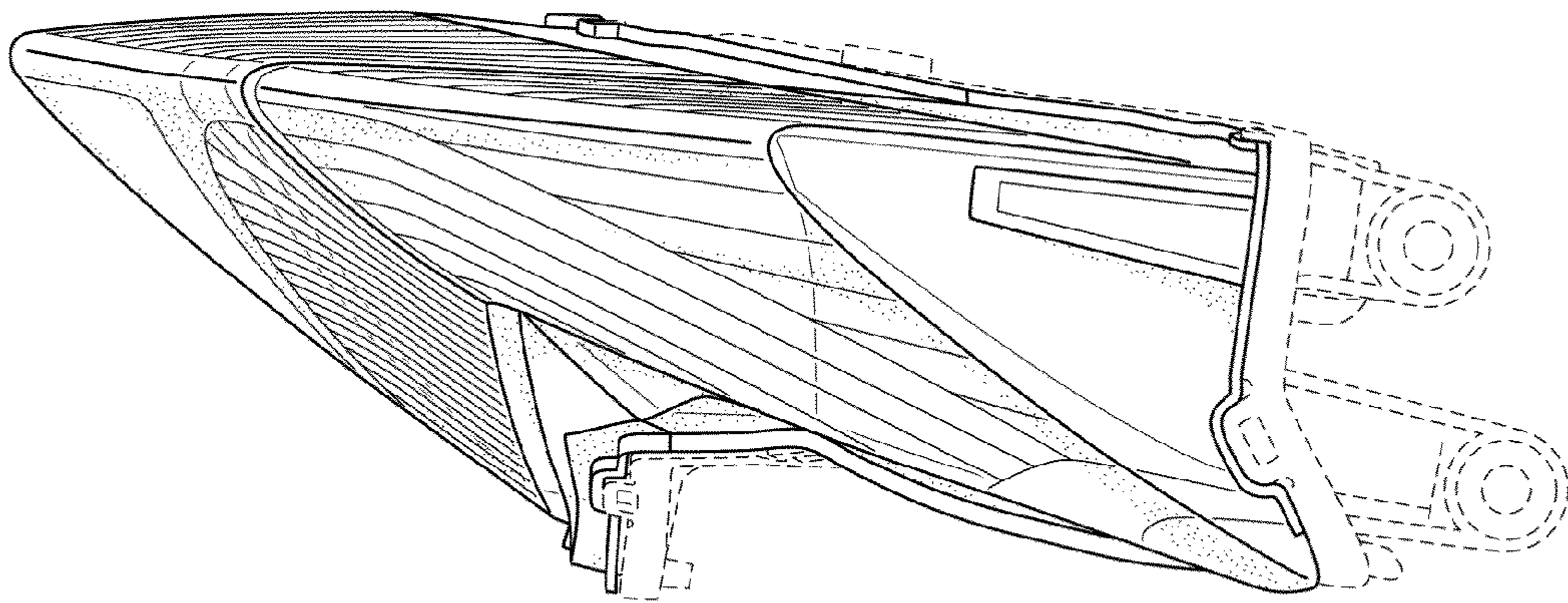

FIG. 10

