

US00D712965S

(12) **United States Design Patent**
Aguilar, Jr.

(10) **Patent No.:** **US D712,965 S**

(45) **Date of Patent:** **** Sep. 9, 2014**

(54) **CRAYON**

(71) Applicant: **Alfredo Adrian Aguilar, Jr.**, Cicero, IL
(US)

(72) Inventor: **Alfredo Adrian Aguilar, Jr.**, Cicero, IL
(US)

(**) Term: **14 Years**

(21) Appl. No.: **29/452,695**

(22) Filed: **Apr. 19, 2013**

(51) **LOC (10) Cl.** **19-06**

(52) **U.S. Cl.**
USPC **D19/181**

(58) **Field of Classification Search**
CPC B43K 19/00; B43K 19/02; B43K 5/005;
B43K 23/004
USPC D14/411; D19/115-186, 192, 194-197;
24/11 R, 11 F, 11 P; 401/99, 192, 195,
401/196

See application file for complete search history.

(56) **References Cited**

U.S. PATENT DOCUMENTS

D88,232 S *	11/1932	Kobak	D1/103
D249,328 S *	9/1978	Fields	D9/646
4,728,212 A *	3/1988	Spector	401/88
D365,849 S *	1/1996	Greer, Jr.	D19/36
5,564,849 A *	10/1996	Greer, Jr.	401/30
D482,392 S *	11/2003	Hui	D19/36

D509,624 S *	9/2005	Villani et al.	D28/8.1
D511,933 S *	11/2005	Abrams	D7/400
D520,058 S *	5/2006	Harrison et al.	D19/36
D525,655 S *	7/2006	Harrison et al.	D19/36
D530,744 S *	10/2006	Harrison et al.	D19/36
D541,338 S *	4/2007	Wang	D19/43
D579,495 S *	10/2008	Yoon	D19/44
D601,690 S *	10/2009	Hodges	D24/102
7,726,894 B2 *	6/2010	Yoon	401/116
D625,163 S *	10/2010	Moman	D8/38
D661,735 S *	6/2012	Yeh	D19/41

* cited by examiner

Primary Examiner — Elizabeth Albert

(74) *Attorney, Agent, or Firm* — Richards Patent Law P.C.

(57) **CLAIM**

The ornamental design for a crayon, as shown and described.

DESCRIPTION

FIG. 1 is a back side perspective view of a crayon showing my new design;
FIG. 2 is a front view thereof;
FIG. 3 is a back view thereof;
FIG. 4 is a left view thereof;
FIG. 5 is a right view thereof;
FIG. 6 is a top view thereof;
FIG. 7 is a bottom view thereof; and,
FIG. 8 is a sectional view thereof, taken along the line "8-8" in FIG. 2.

1 Claim, 2 Drawing Sheets

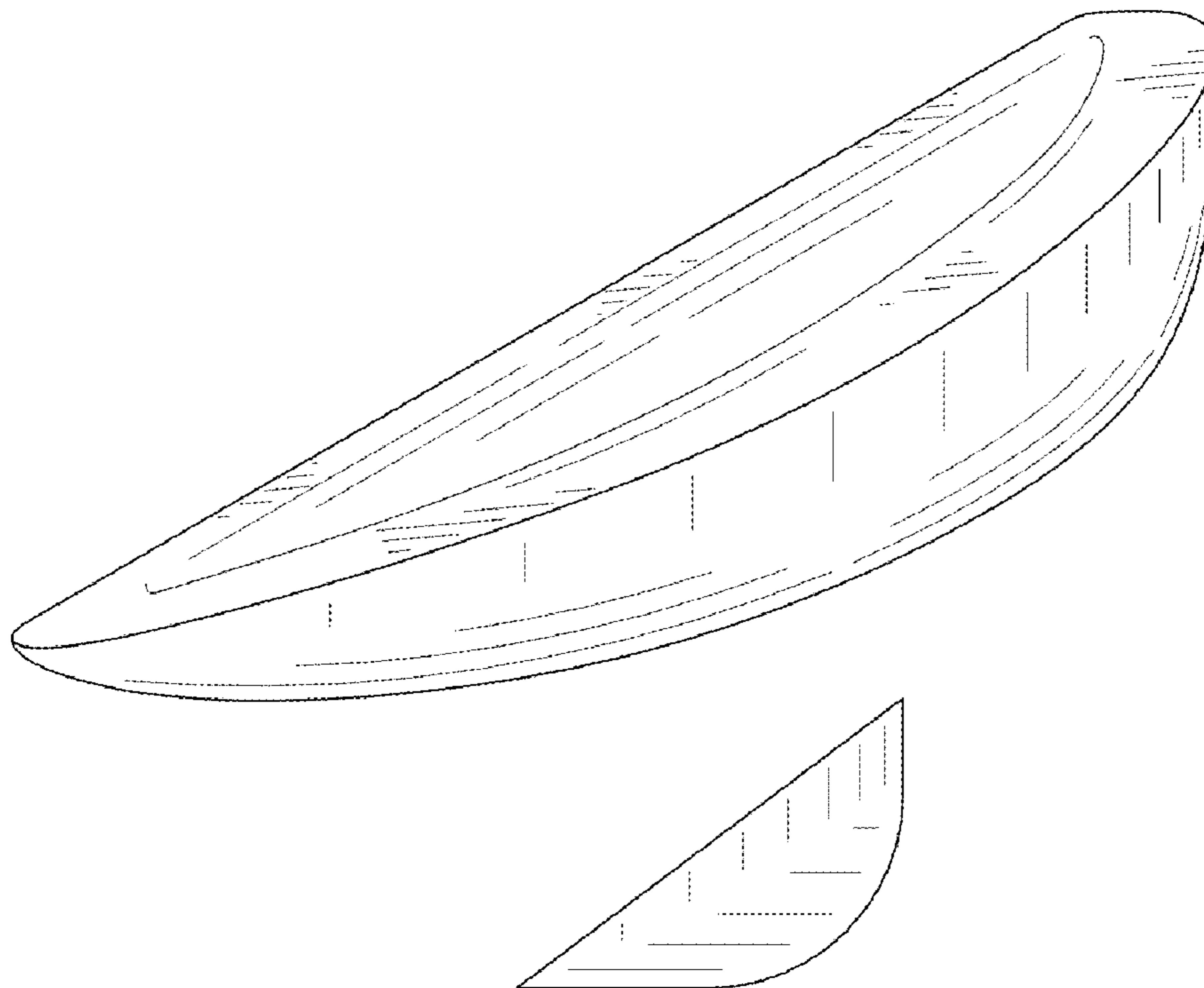

FIG. 1

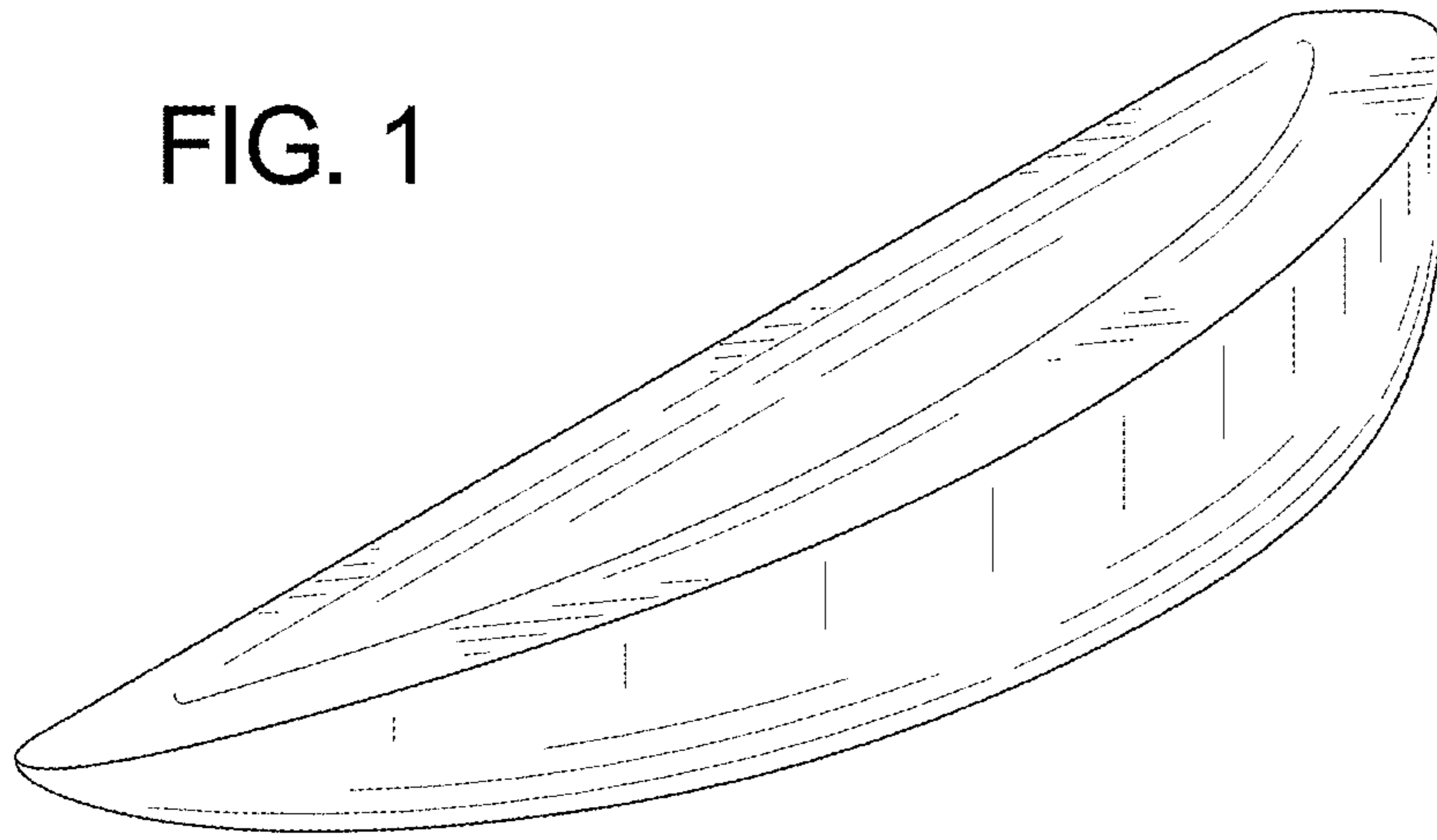

FIG. 2

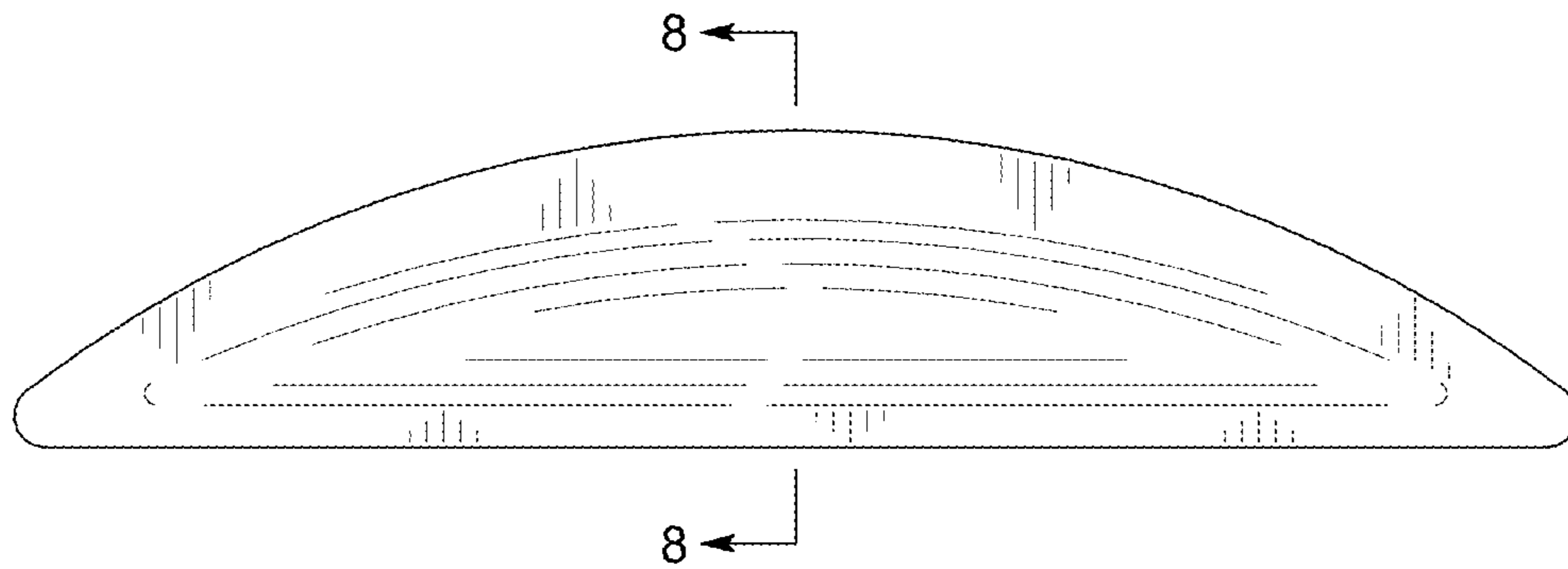

FIG. 3

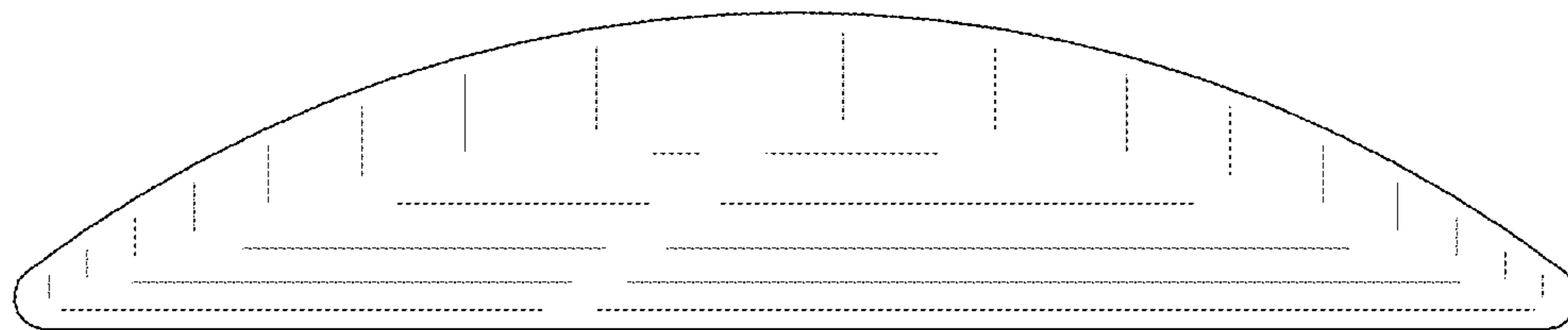

FIG. 4

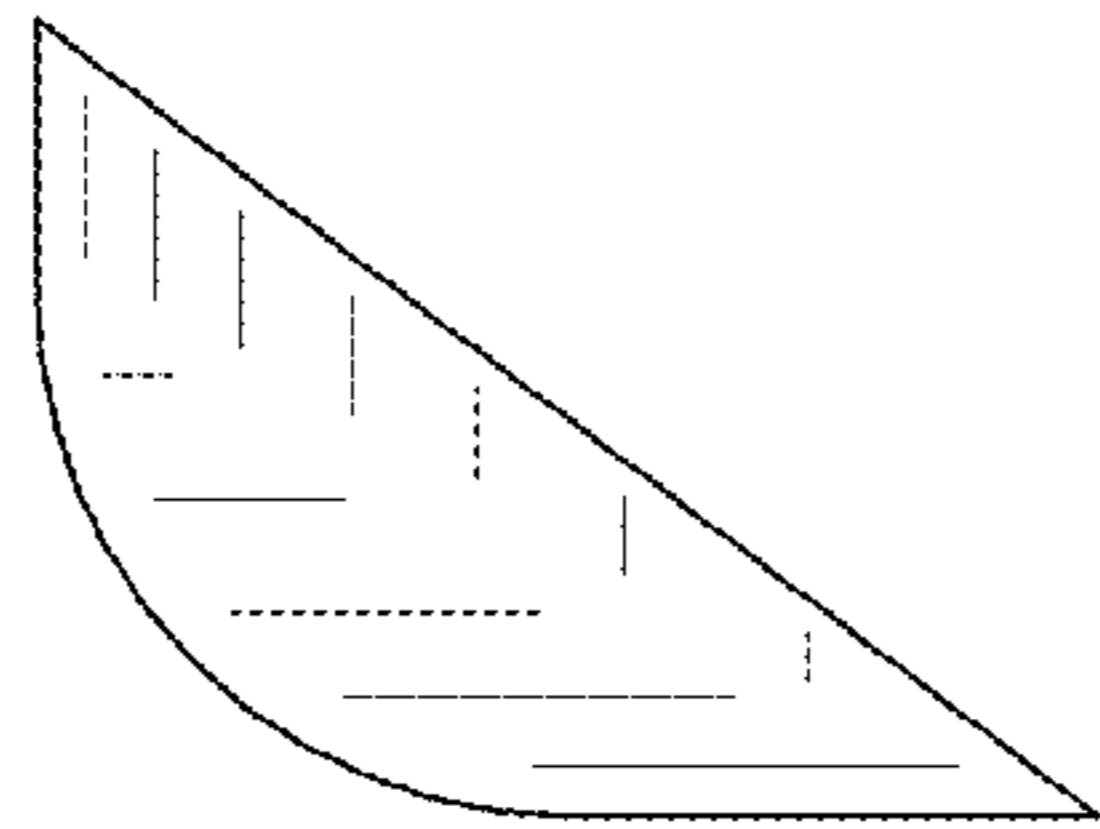

FIG. 5

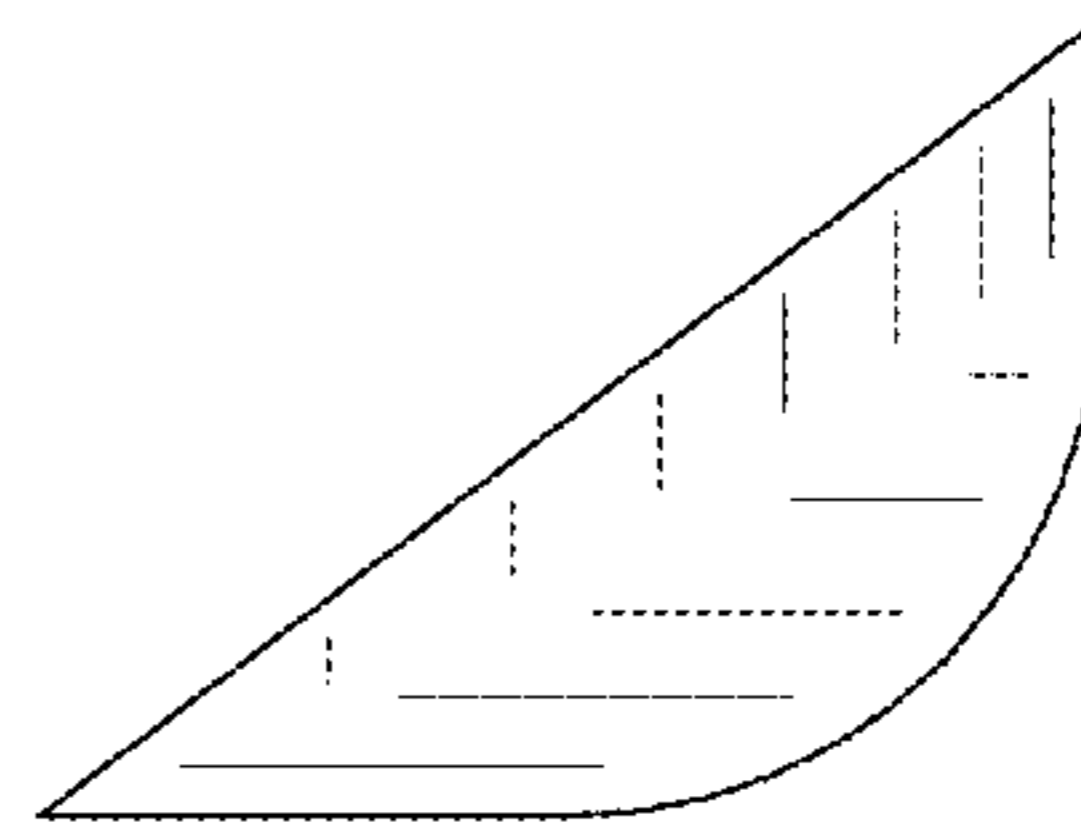

FIG. 6

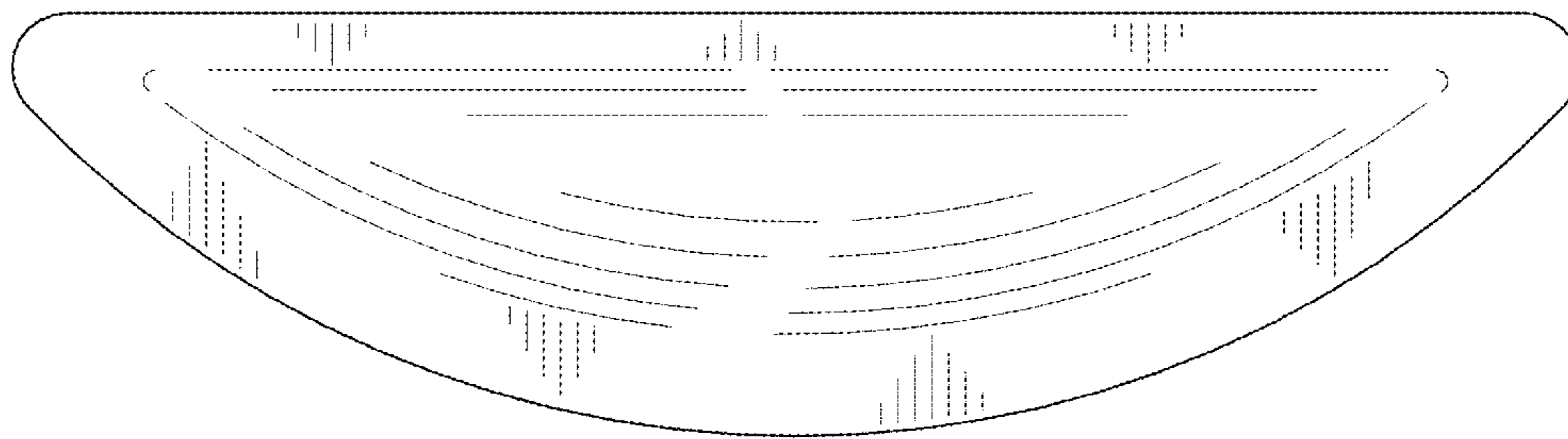

FIG. 7

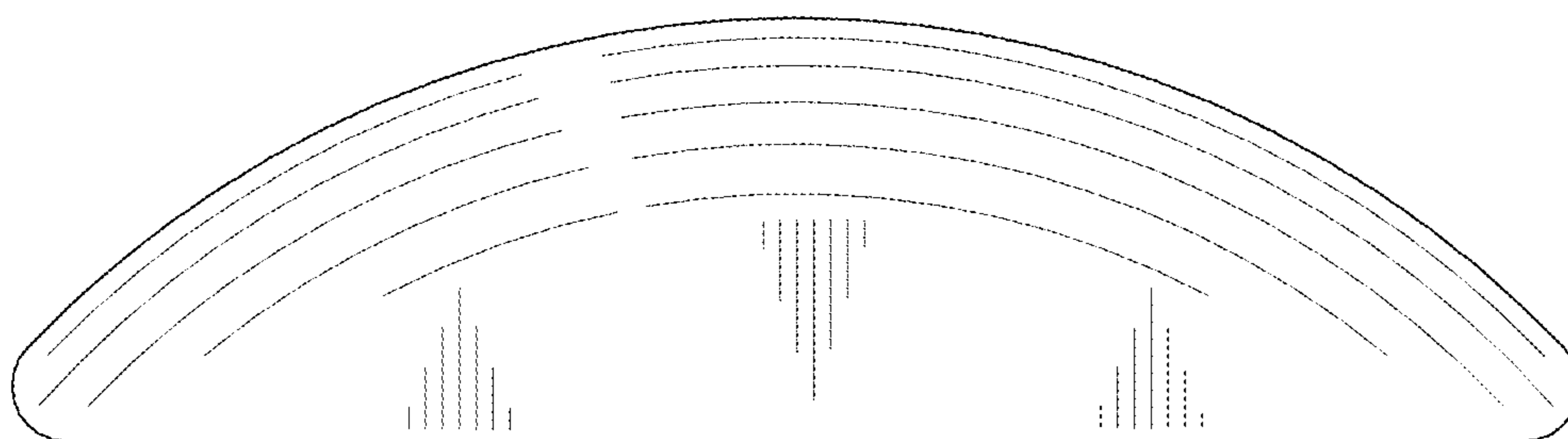

FIG. 8

