



US00D712865S

(12) **United States Design Patent**
Mauritzson et al.

(10) **Patent No.:** **US D712,865 S**

(45) **Date of Patent:** **** Sep. 9, 2014**

(54) **MOBILE PHONE**

(71) Applicant: **Sony Mobile Communications AB,**
Lund (SE)

(72) Inventors: **Daniel Mauritzson,** Malmo (SE); **Bilgi**
Karan, Lund (SE)

(73) Assignee: **Sony Mobile Communications AB,**
Lund (SE)

(**) Term: **14 Years**

(21) Appl. No.: **29/444,023**

(22) Filed: **Jan. 25, 2013**

(30) **Foreign Application Priority Data**

Oct. 22, 2012 (EM) 002123059-0001

(51) **LOC (10) Cl.** **14-03**

(52) **U.S. Cl.**
USPC **D14/138 G**

(58) **Field of Classification Search**
CPC H04M 1/0202; H04M 1/0235; H04M
1/0237; H04M 1/0239; H04M 2250/22
USPC D14/138 R, 138 AD, 138 AC, 138 C,
D14/138 G, 137, 341-347, 247-248;
455/566, 575.1, 575.3, 575.4

See application file for complete search history.

(56) **References Cited**

U.S. PATENT DOCUMENTS

D569,837 S * 5/2008 Baik et al. D14/138 G
D589,021 S * 3/2009 Millora D14/138 AD
D607,858 S * 1/2010 Millora D14/138 AD
D640,220 S * 6/2011 Shyu et al. D14/138 G
D646,661 S * 10/2011 Kim D14/138 AD
D654,460 S * 2/2012 Kim et al. D14/138 G
D656,118 S * 3/2012 Kim et al. D14/138 G

D664,518 S * 7/2012 Ryu D14/138 G
D671,905 S * 12/2012 Mauritzson D14/138 G
D673,131 S * 12/2012 Sugiyama D14/138 G
D673,561 S * 1/2013 Hyun et al. D14/341
D675,589 S * 2/2013 Han et al. D14/138 G
D677,233 S * 3/2013 Mauritzson D14/138 G
D677,234 S * 3/2013 Hirano D14/138 G

(Continued)

FOREIGN PATENT DOCUMENTS

TW D133576 3/2010
TW D133917 3/2010
TW D147380 6/2012
TW D149042 9/2012

OTHER PUBLICATIONS

Sony Xperia ZL, announced Jan. 2013, [online], [retrieved on Mar. 5, 2013]. Retrieved from Internet ,<URL: <http://www.gsmarena.com>>.*

(Continued)

Primary Examiner — Bridget L Eland

(74) *Attorney, Agent, or Firm* — Renner, Otto, Boisselle & Sklar, LLP

(57) **CLAIM**

The ornamental design for a mobile phone, as shown and described.

DESCRIPTION

FIG. 1 is a perspective view of a mobile phone showing our new design;

FIG. 2 is a front view thereof;

FIG. 3 is a rear view thereof;

FIG. 4 is a left side view thereof;

FIG. 5 is a right side view thereof;

FIG. 6 is a top view thereof; and,

FIG. 7 is a bottom view thereof.

1 Claim, 3 Drawing Sheets

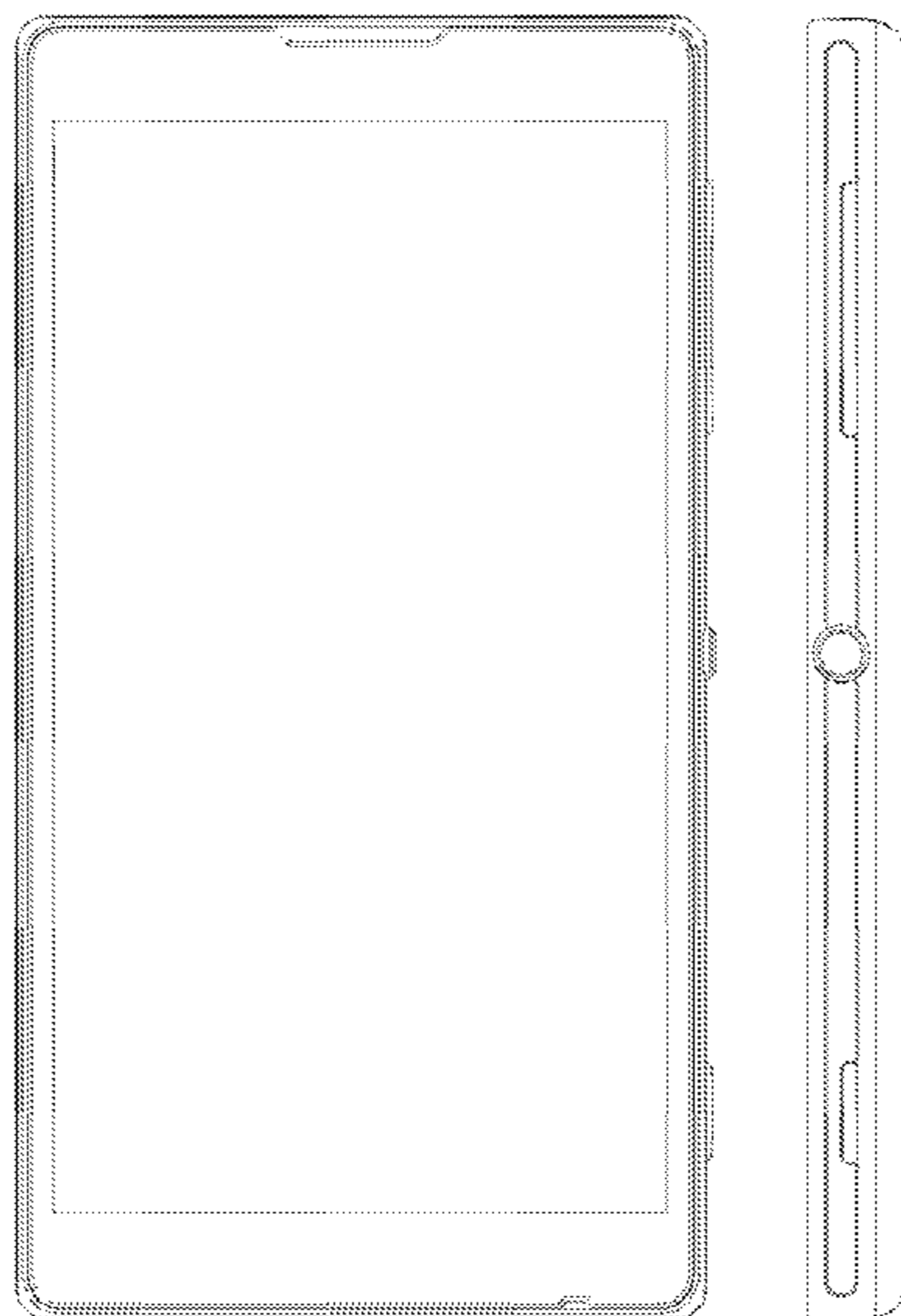

(56)

References Cited

U.S. PATENT DOCUMENTS

D677,235	S *	3/2013	Hibi	D14/138	G
D683,325	S *	5/2013	Sugiyama	D14/138	G
D684,968	S *	6/2013	Smith et al.	D14/341	
D694,730	S *	12/2013	Lee	D14/138	G
D695,702	S *	12/2013	Kim	D14/138	G
D696,218	S *	12/2013	Lee et al.	D14/138	G
D696,219	S *	12/2013	Kim et al.	D14/138	G
D698,746	S *	2/2014	Kaneta	D14/138	G
2007/0287512	A1 *	12/2007	Kilpi et al.	455/575.1	
2010/0267428	A1 *	10/2010	Wang et al.	455/575.4	
2011/0143769	A1 *	6/2011	Jones et al.	455/456.1	
2012/0157174	A1 *	6/2012	Woo et al.	455/575.4	

OTHER PUBLICATIONS

Sony Xperia Z, announced Jan. 2013, [online], [retrieved on Mar. 5, 2013]. Retrieved from Internet ,<URL: <http://www.gsmarena.com>>.*

Sony Xperia Z Ultra, announced Jun. 2013, [online], [retrieved on May 30, 2014]. Retrieved from Internet ,<URL: <http://www.gsmarena.com>>.*

Sony Xperia Z1, announced Sep. 2013, [online], [retrieved on May 30, 2014]. Retrieved from Internet ,<URL: <http://www.gsmarena.com>>.*

Sony Xperia Z1 Compact, announced Jan. 2014, [online], [retrieved on May 30, 2014]. Retrieved from Internet ,<URL: <http://www.gsmarena.com>>.*

LG Optimus 3D Max P720, announced Feb. 2012, [online], [retrieved on Mar. 15, 2012]. Retrieved from Internet ,<URL: <http://www.gsmarena.com>>.*

LG Optimus 4X HD P880, announced Feb. 2012, [online], [retrieved on Mar. 15, 2012]. Retrieved from Internet ,<URL: <http://www.gsmarena.com>>.*

LG Optimus 2X, announced Dec. 2010, [online], [retrieved on Jan. 6, 2011]. Retrieved from Internet ,<URL: <http://www.gsmarena.com>>.*

Drawings from co-owned Design U.S. Appl. No. 29/444,013, filed Jan. 25, 2013.

* cited by examiner

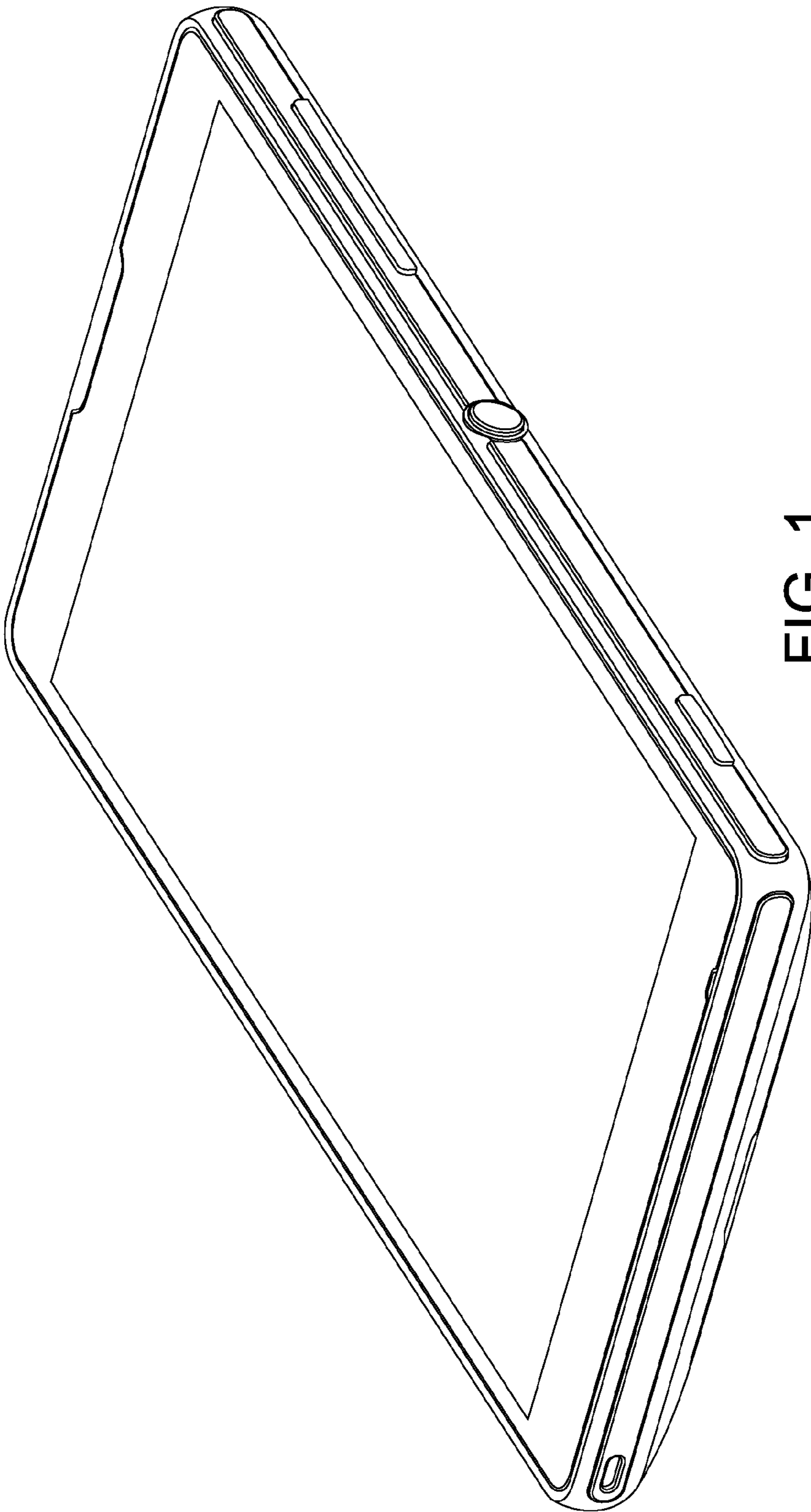

FIG. 1

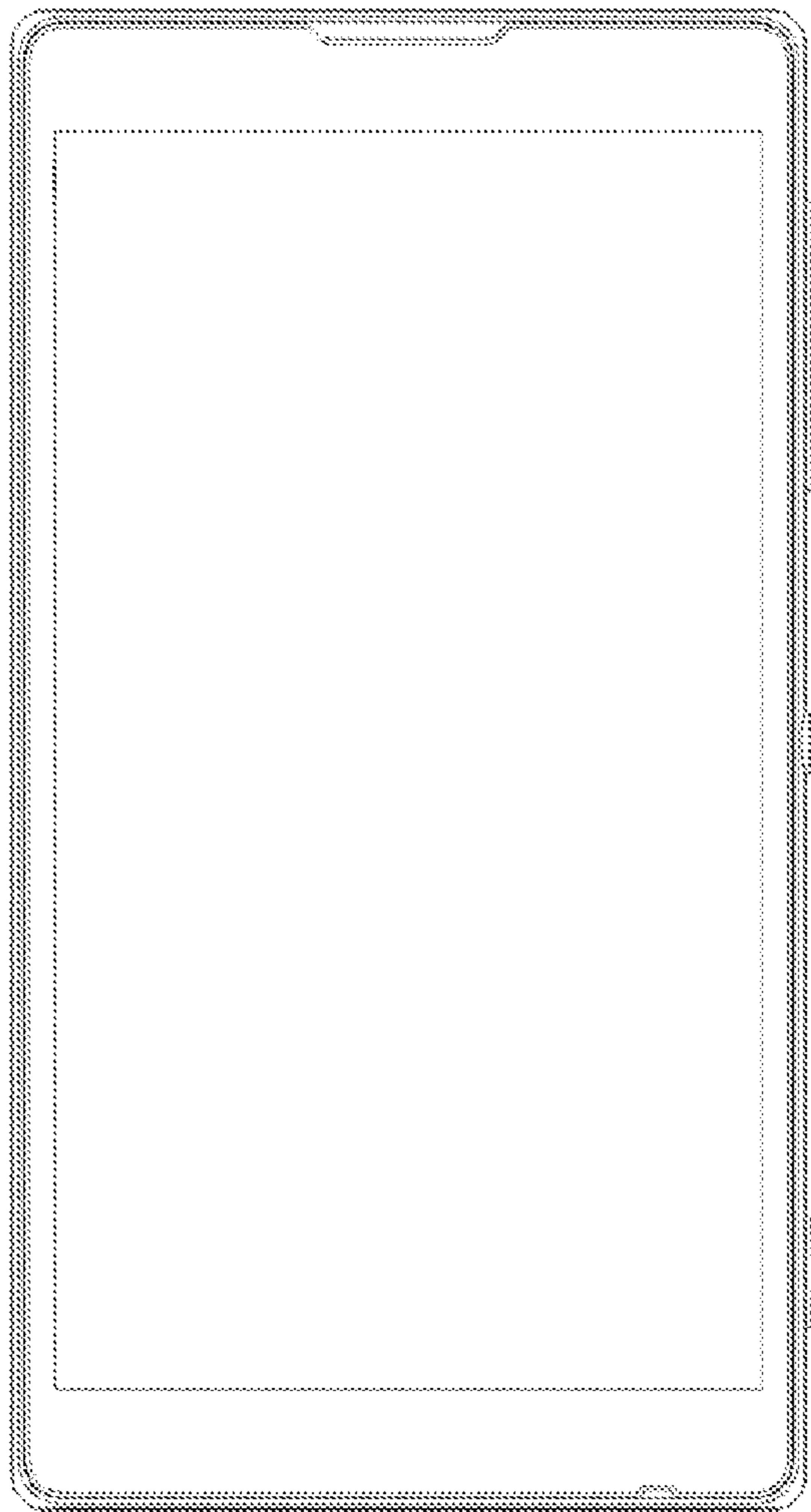

FIG. 2

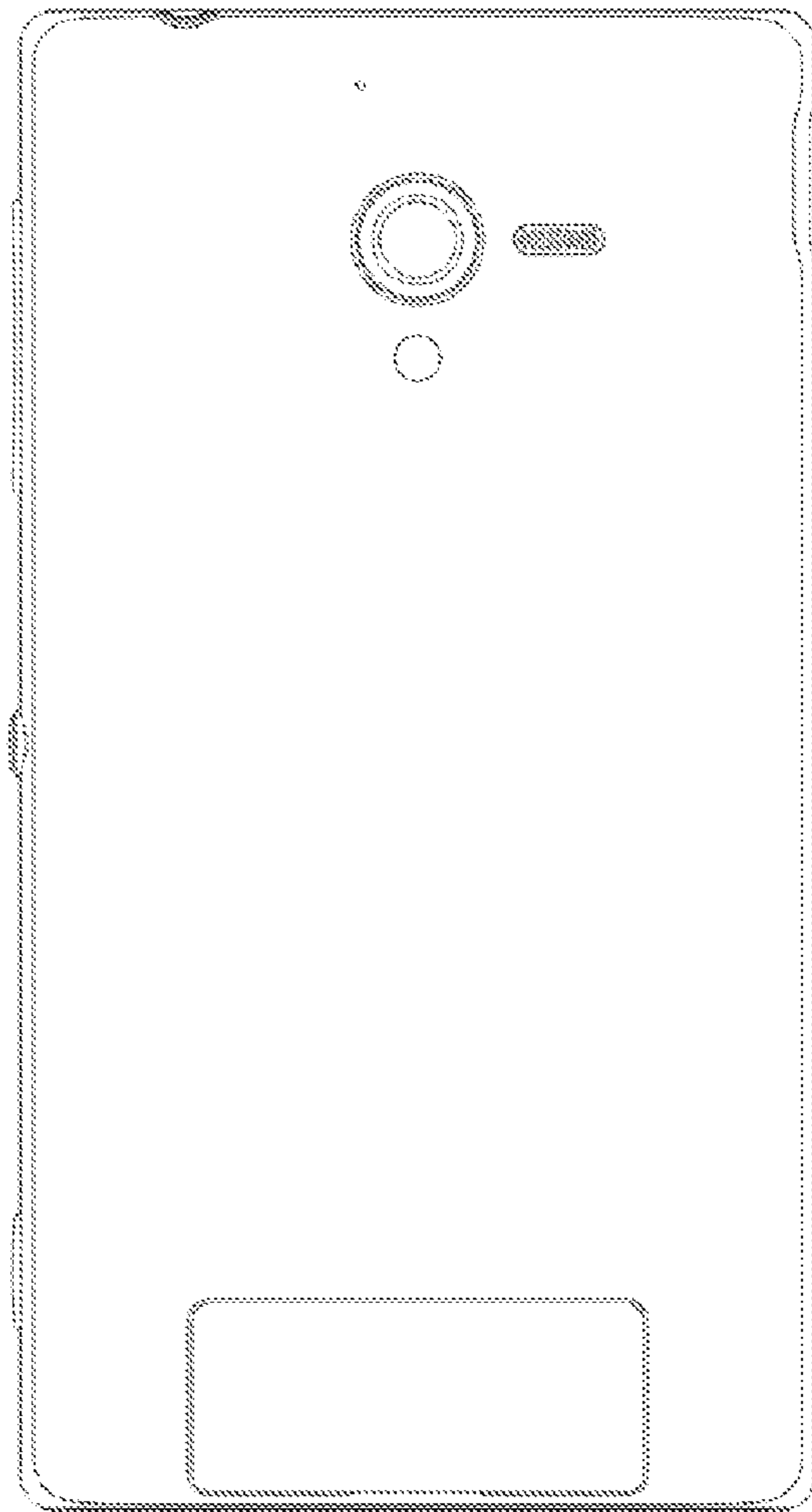

FIG. 3

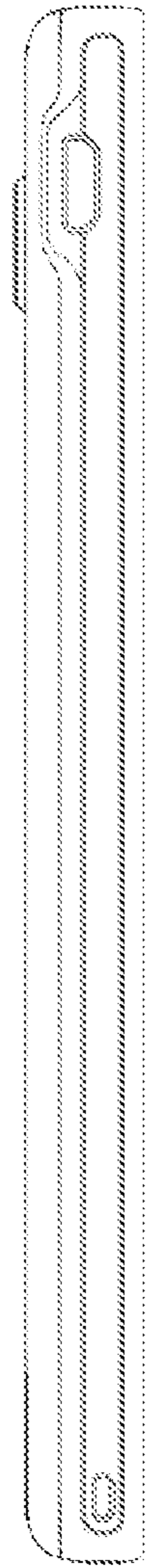

FIG. 4

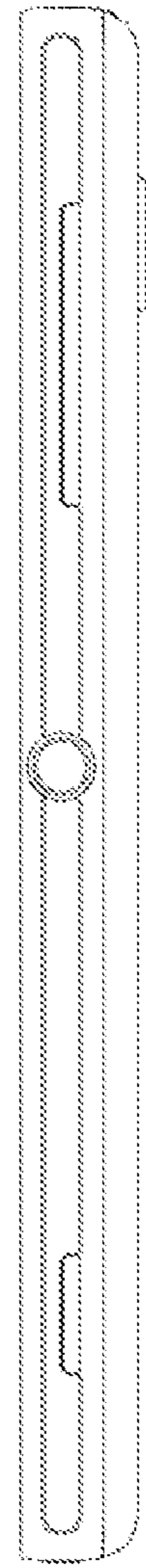

FIG. 5

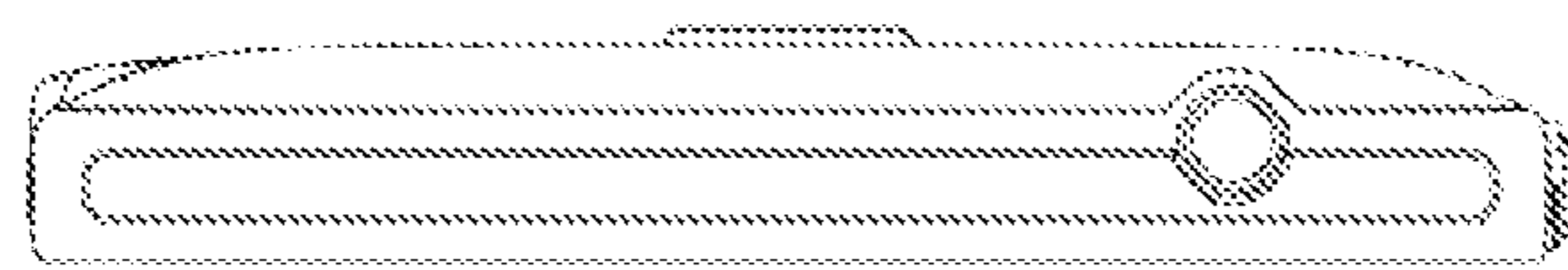

FIG. 6

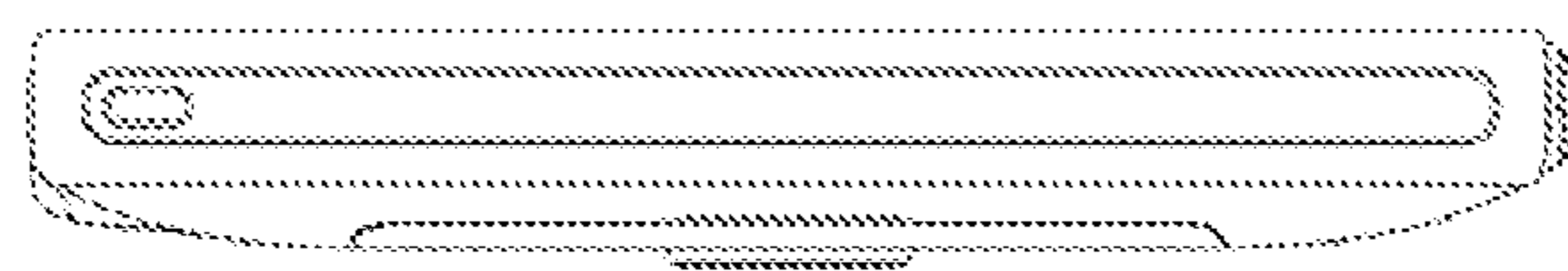

FIG. 7