



US00D712805S

(12) **United States Design Patent**
Murkett

(10) **Patent No.:** **US D712,805 S**

(45) **Date of Patent:** **** Sep. 9, 2014**

(54) **REAR BUMPER FOR A MOTOR VEHICLE**

(71) Applicant: **Dr. Ing. h.c. F. Porsche**
Aktiengesellschaft, Stuttgart (DE)

(72) Inventor: **Stephen Murkett, Gerlingen (DE)**

(73) Assignee: **Dr. Ing. h.c. F. Porsche**
Aktiengesellschaft, Stuttgart (DE)

(**) Term: **14 Years**

(21) Appl. No.: **29/466,760**

(22) Filed: **Sep. 11, 2013**

(30) **Foreign Application Priority Data**

Mar. 13, 2013 (DE) 40 2013 100 218

(51) **LOC (10) Cl.** **12-16**

(52) **U.S. Cl.**
USPC **D12/169**

(58) **Field of Classification Search**
CPC combination set(s) only.
See application file for complete search history.

(56) **References Cited**

U.S. PATENT DOCUMENTS

D630,976 S * 1/2011 Clottu D12/169
D639,215 S * 6/2011 Faghihzadeh D12/169

D640,613 S * 6/2011 Bauer et al. D12/169
D663,660 S * 7/2012 Platto et al. D12/169
D675,136 S * 1/2013 Hamilton et al. D12/169
D678,146 S * 3/2013 Behmer et al. D12/169
D683,671 S * 6/2013 Platto et al. D12/169
D692,808 S * 11/2013 Morioka D12/169
D696,168 S * 12/2013 Ito D12/169

* cited by examiner

Primary Examiner — Melody N Brown

(74) *Attorney, Agent, or Firm* — RatnerPrestia

(57) **CLAIM**

The ornamental design for a rear bumper for a motor vehicle, as shown and described.

DESCRIPTION

FIG. 1 is a perspective view of a rear bumper for a motor vehicle;
FIG. 2 is a rear elevation view of a body part thereof;
FIG. 3 is a front elevation view of a body part thereof;
FIG. 4 is an elevation view thereof from the left side of a body part;
FIG. 5 is an elevation view thereof from the right side of a body part;
FIG. 6 is a top plan view of a body part thereof; and,
FIG. 7 is a bottom plan view of a body part thereof.

1 Claim, 4 Drawing Sheets

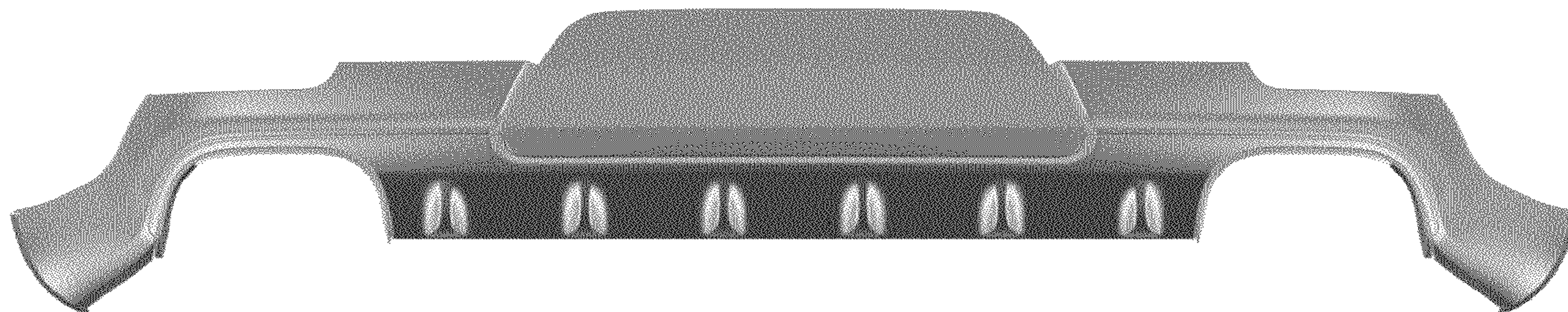

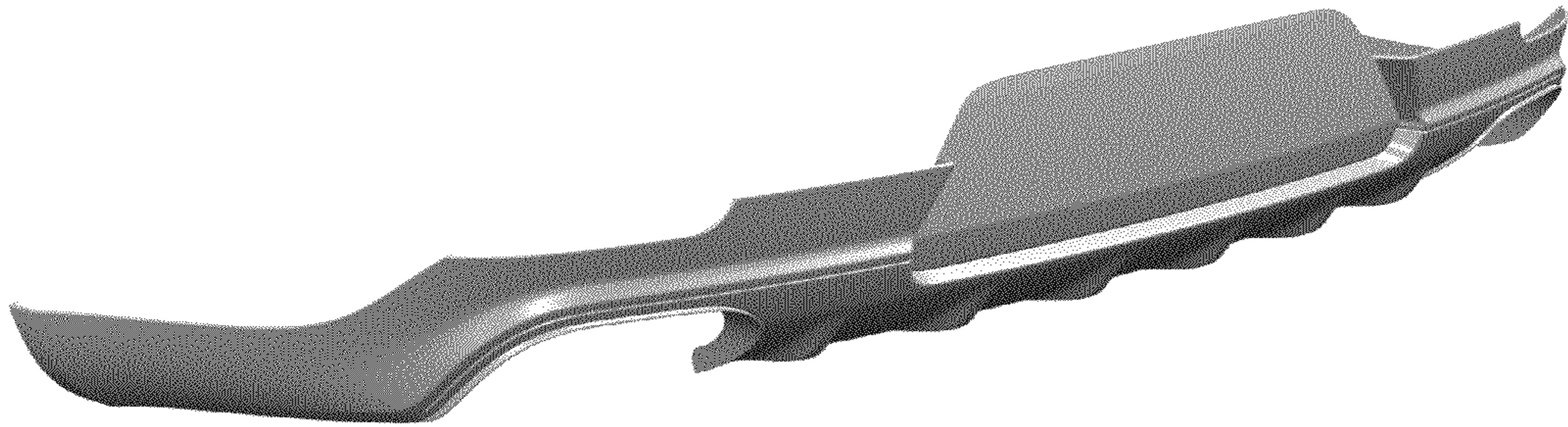

Figure 1

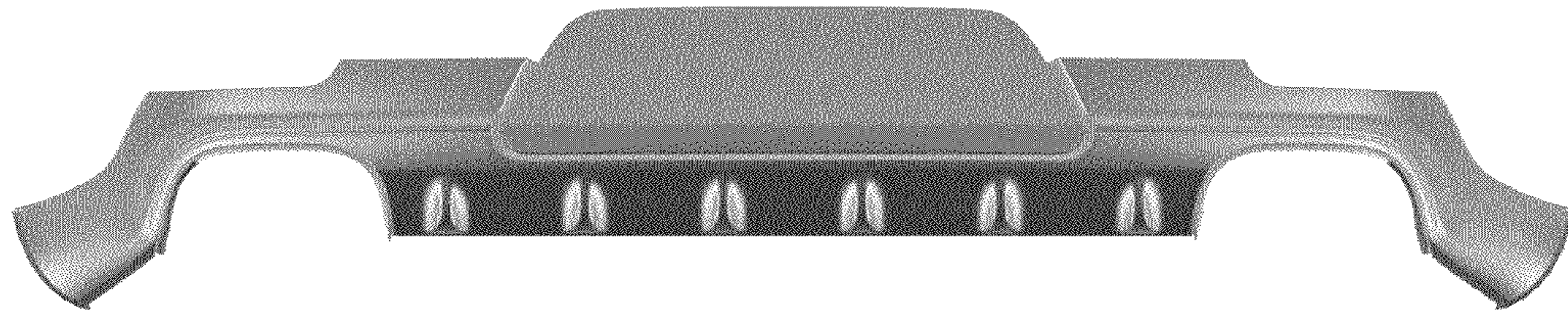

Figure 2

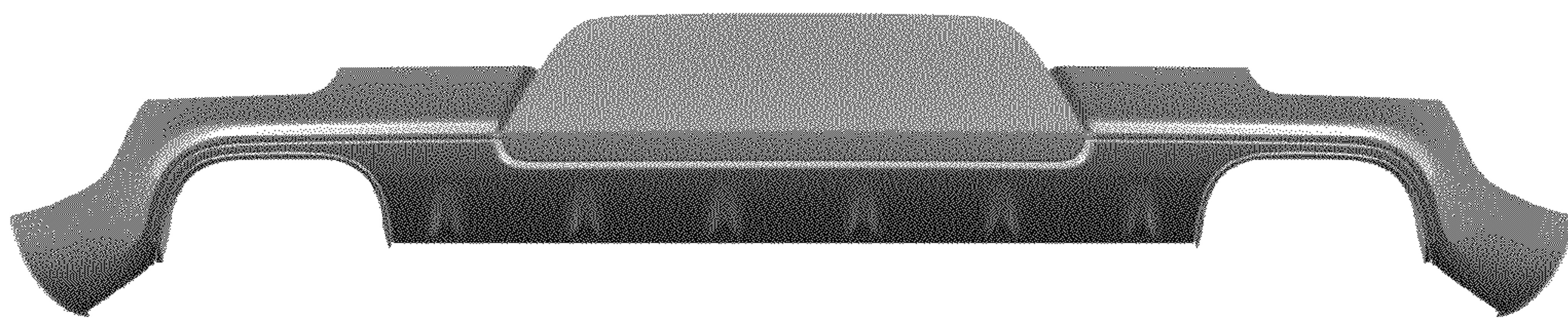

Figure 3

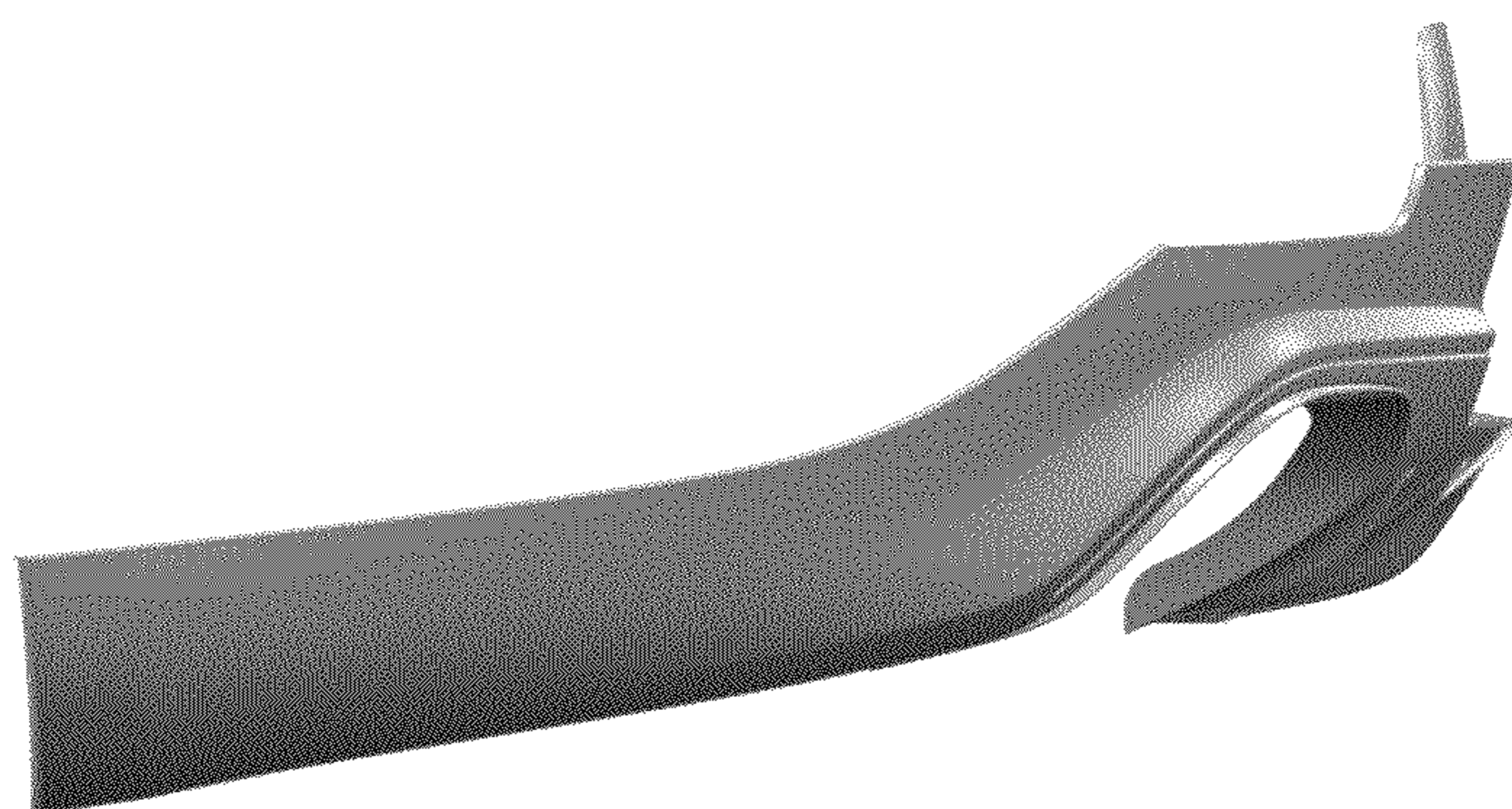

Figure 4

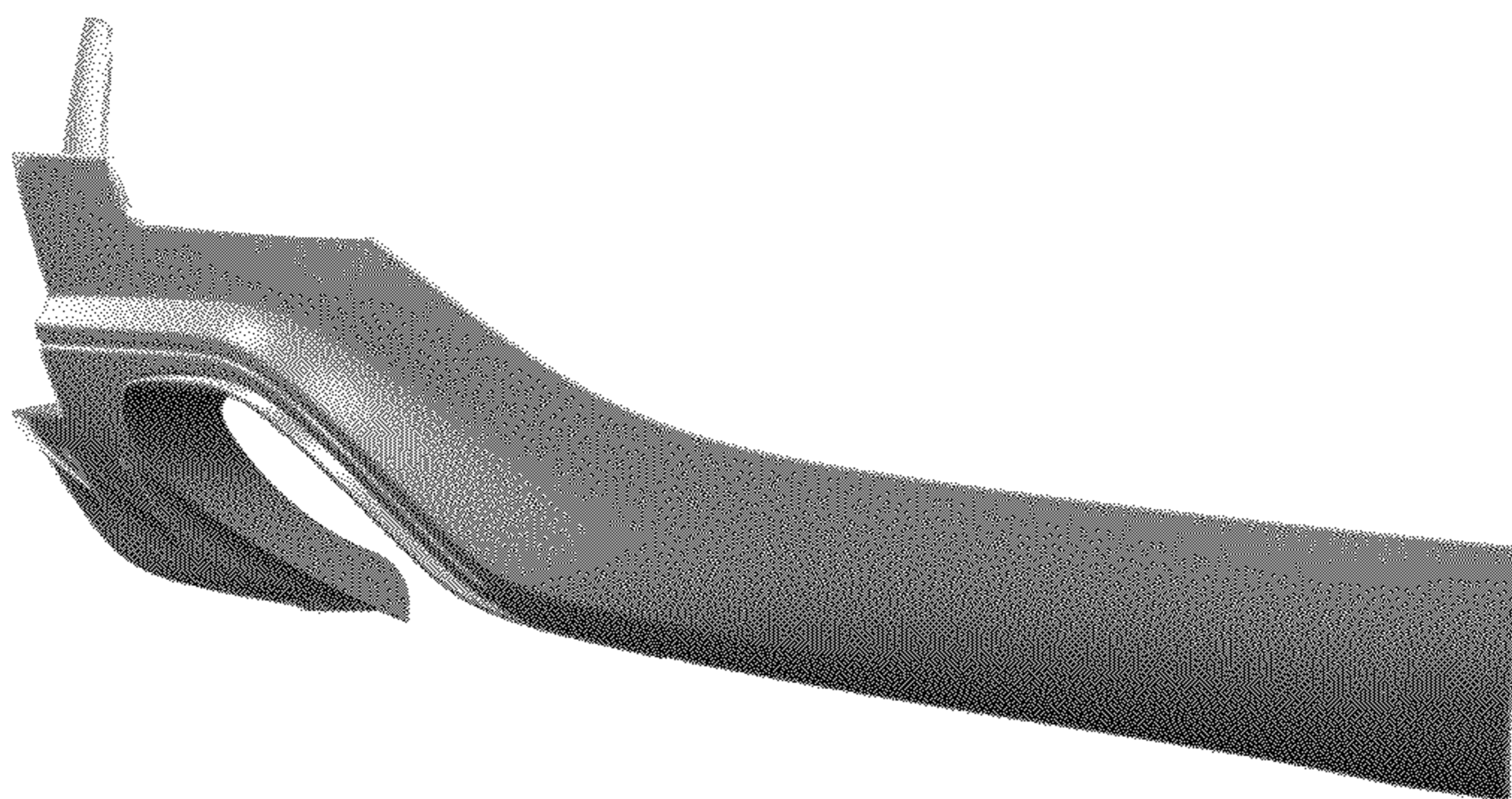

Figure 5

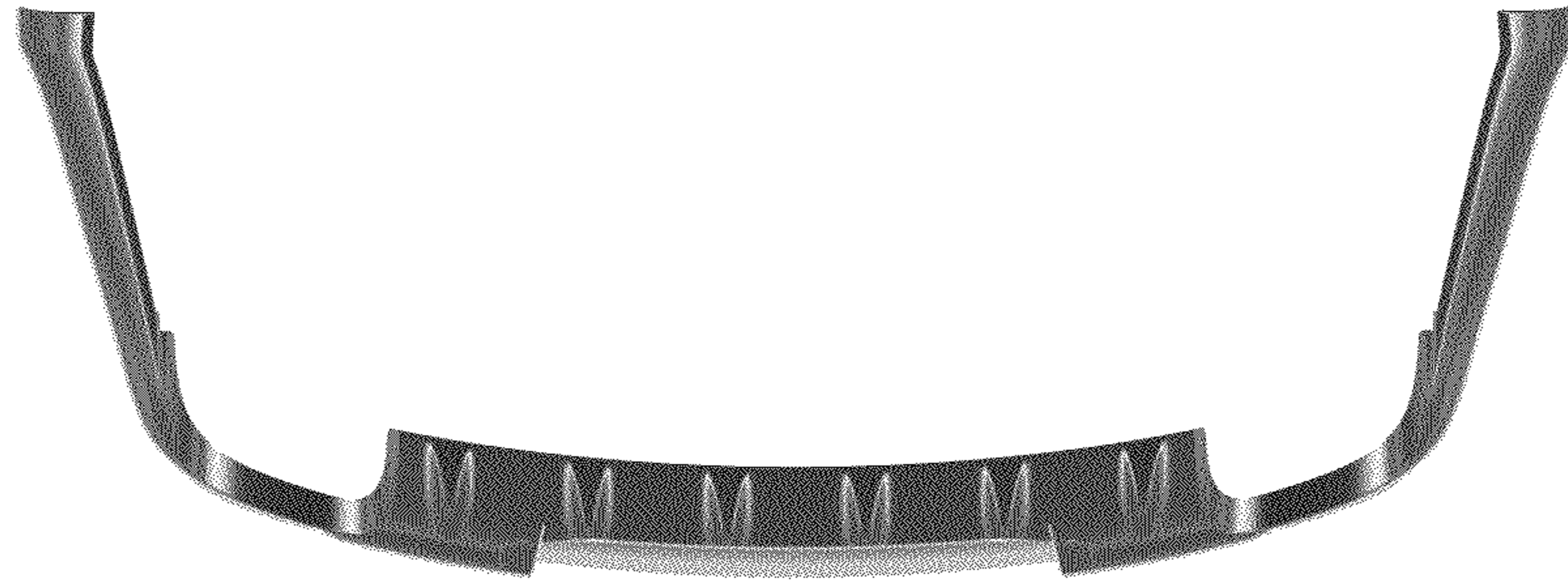

Figure 6

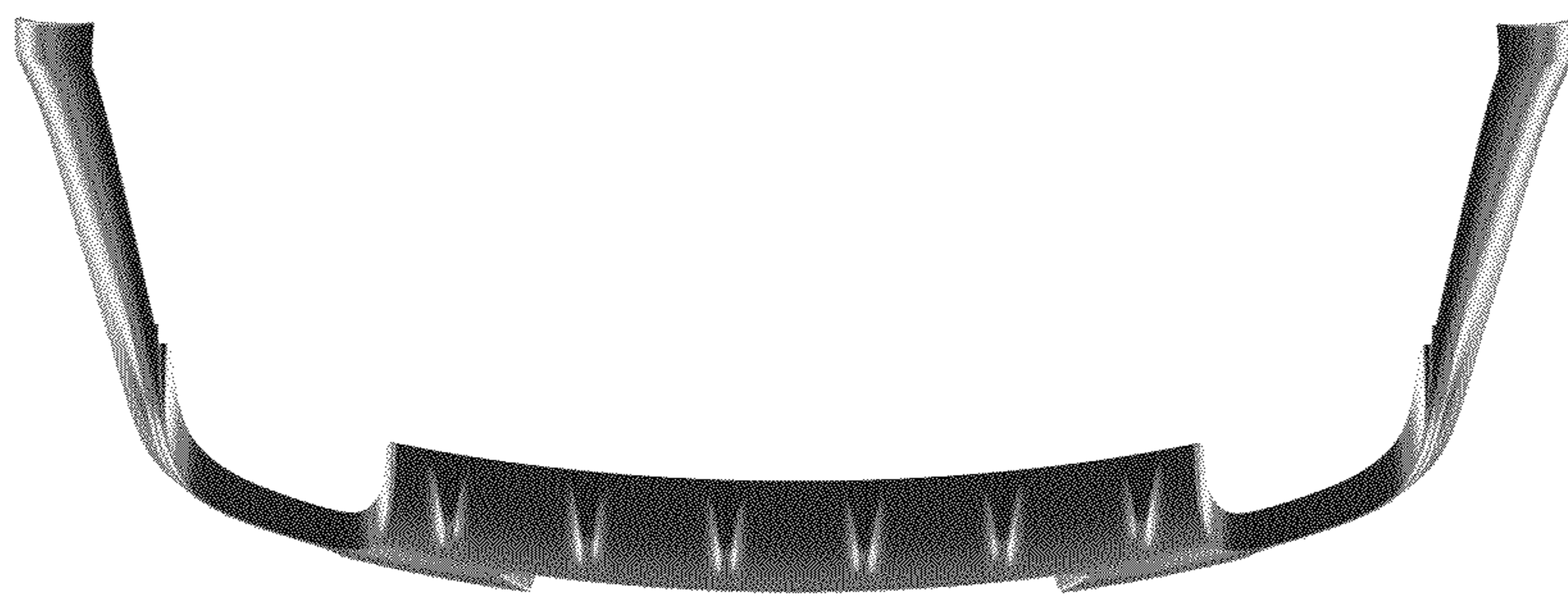

Figure 7