



US00D712610S

(12) **United States Design Patent**
Arvinte et al.

(10) **Patent No.:** **US D712,610 S**
(45) **Date of Patent:** **** Sep. 2, 2014**

- (54) **PAINT BRUSH CLEANER**
- (71) Applicant: **A. Richard Tools Co./Outils A. Richard Co.,** Berthierville (CA)
- (72) Inventors: **Romeo Arvinte,** Laval-des-Rapides (CA); **Francois Panfli,** Berthierville (CA)
- (73) Assignee: **A. Richard Tools Co./Outils A. Richard,** Berthierville, Quebec (CA)

6,530,109	B1	3/2003	Cassedy	
D484,704	S	1/2004	Fong	
D498,649	S	11/2004	Di Bitonto et al.	
D504,234	S	4/2005	Kuo et al.	
6,901,622	B2	6/2005	Thompson et al.	
D508,327	S	8/2005	Julemont	
D511,946	S *	11/2005	Overthun et al. D7/678
7,100,537	B1	9/2006	Suen et al.	
D535,794	S *	1/2007	Lundy et al. D32/53.1
D543,704	S	6/2007	Leung	
D547,068	S	7/2007	Major	
D569,200	S *	5/2008	Chalfant et al. D7/672
D578,772	S *	10/2008	Provost et al. D4/136
D601,807	S	10/2009	Choi	

(**) Term: **14 Years**

(Continued)

(21) Appl. No.: **29/459,050**

FOREIGN PATENT DOCUMENTS

(22) Filed: **Jun. 25, 2013**

CA	2 463 414	A1	10/2005
CA	2 650 875	A1	7/2010

(51) **LOC (10) Cl.** **08-99**

(52) **U.S. Cl.**
USPC **D32/35**

Primary Examiner — Deanna L Pratt
Assistant Examiner — Natasha Vujcic
(74) *Attorney, Agent, or Firm* — Merchant & Gould P.C.

(58) **Field of Classification Search**
USPC D32/35, 40, 52, 53.1; D4/100, 113, D4/115, 117, 119, 121, 129, 130, 131, 132, D4/133, 134, 135, 136, 138, 199; D7/672, D7/673, 678; D8/300, 303, 307; 15/21.1, 15/38, 39, 106, 159.1, 160
See application file for complete search history.

(57) **CLAIM**
The ornamental design for a paint brush cleaner, as shown and described.

DESCRIPTION

(56) **References Cited**

U.S. PATENT DOCUMENTS

200,218	A *	2/1878	Nicholson 15/106
D13,457	S	11/1882	Brill	
D14,572	S	1/1884	Gridley	
D149,965	S	6/1948	Muller-Munk	
3,574,885	A	4/1971	Jones	
D256,294	S	8/1980	Su	
D273,725	S *	5/1984	Goetz D32/53.1
D356,442	S	3/1995	Hayes et al.	
5,502,873	A	4/1996	Hogan	
D389,618	S	1/1998	Rosen	
D461,288	S *	8/2002	Tennant D32/53.1

FIG. 1 is a top perspective view of a paint brush cleaner showing our new design;
FIG. 2 is a bottom perspective view thereof;
FIG. 3 is a rear view thereof;
FIG. 4 is a front view thereof;
FIG. 5 is a left side view thereof;
FIG. 6 is a right side view thereof;
FIG. 7 is a top plan view thereof; and,
FIG. 8 is a bottom plan view thereof.
The portions shown in dashed lines form no part of the claimed design.

1 Claim, 6 Drawing Sheets

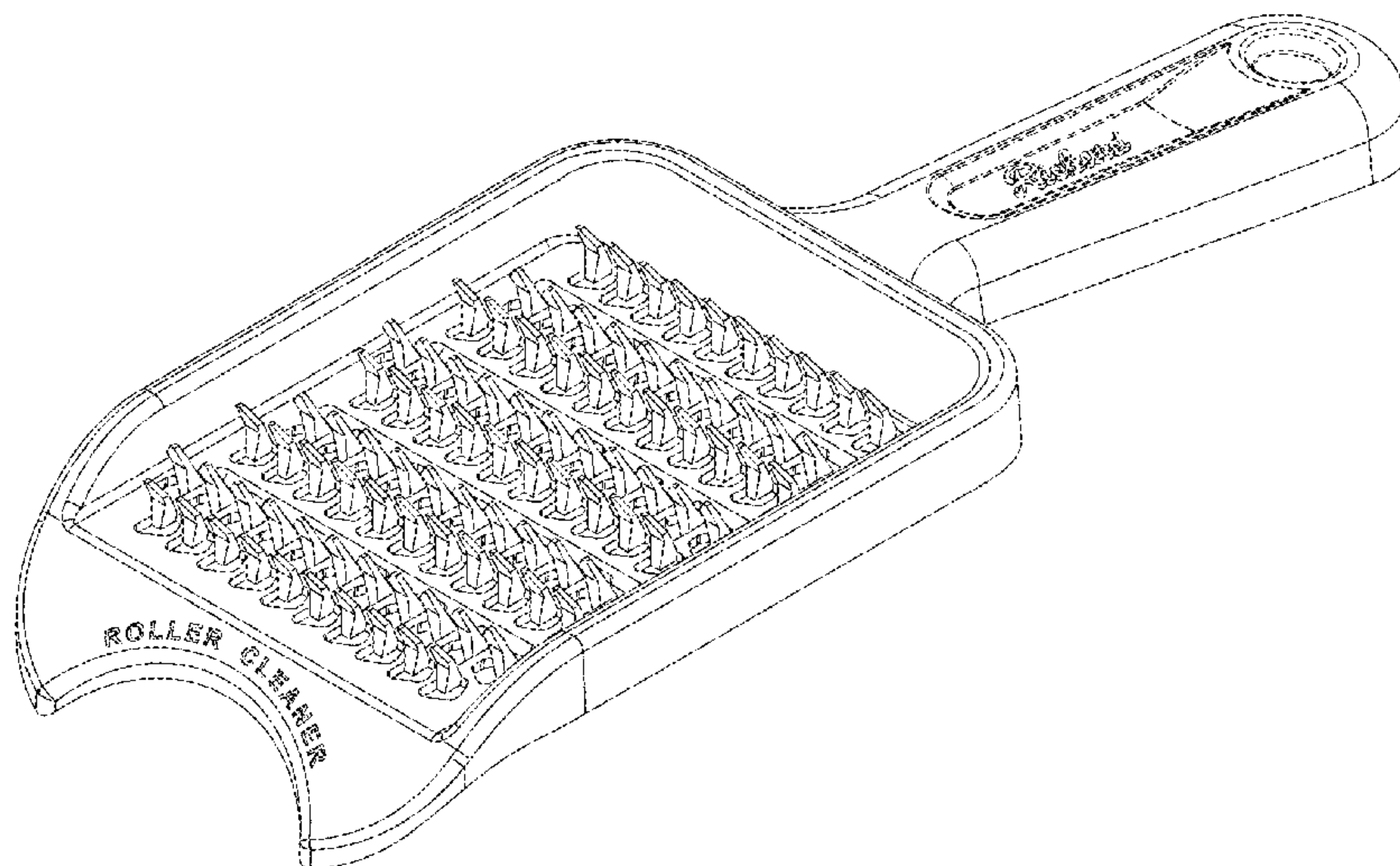

(56)

References Cited

U.S. PATENT DOCUMENTS

D604,124 S * 11/2009 Smith et al. D7/678
D604,919 S 11/2009 Meyet
D613,912 S 4/2010 Benacquisto
D636,957 S 4/2011 Raven
D642,875 S 8/2011 Mah et al.
D642,876 S * 8/2011 Tetreault D7/678
D646,898 S 10/2011 Raven

D652,594 S 1/2012 Zemel
D665,548 S * 8/2012 Arvinte et al. D32/35
D666,463 S * 9/2012 Smith et al. D7/678
D668,918 S * 10/2012 Smith et al. D7/678
D673,745 S * 1/2013 Pung et al. D32/40
D684,329 S * 6/2013 Church D32/53.1
D697,315 S * 1/2014 Schouten et al. D4/138
2002/0096125 A1 7/2002 Fong
2011/0017232 A1 1/2011 Junkins

* cited by examiner

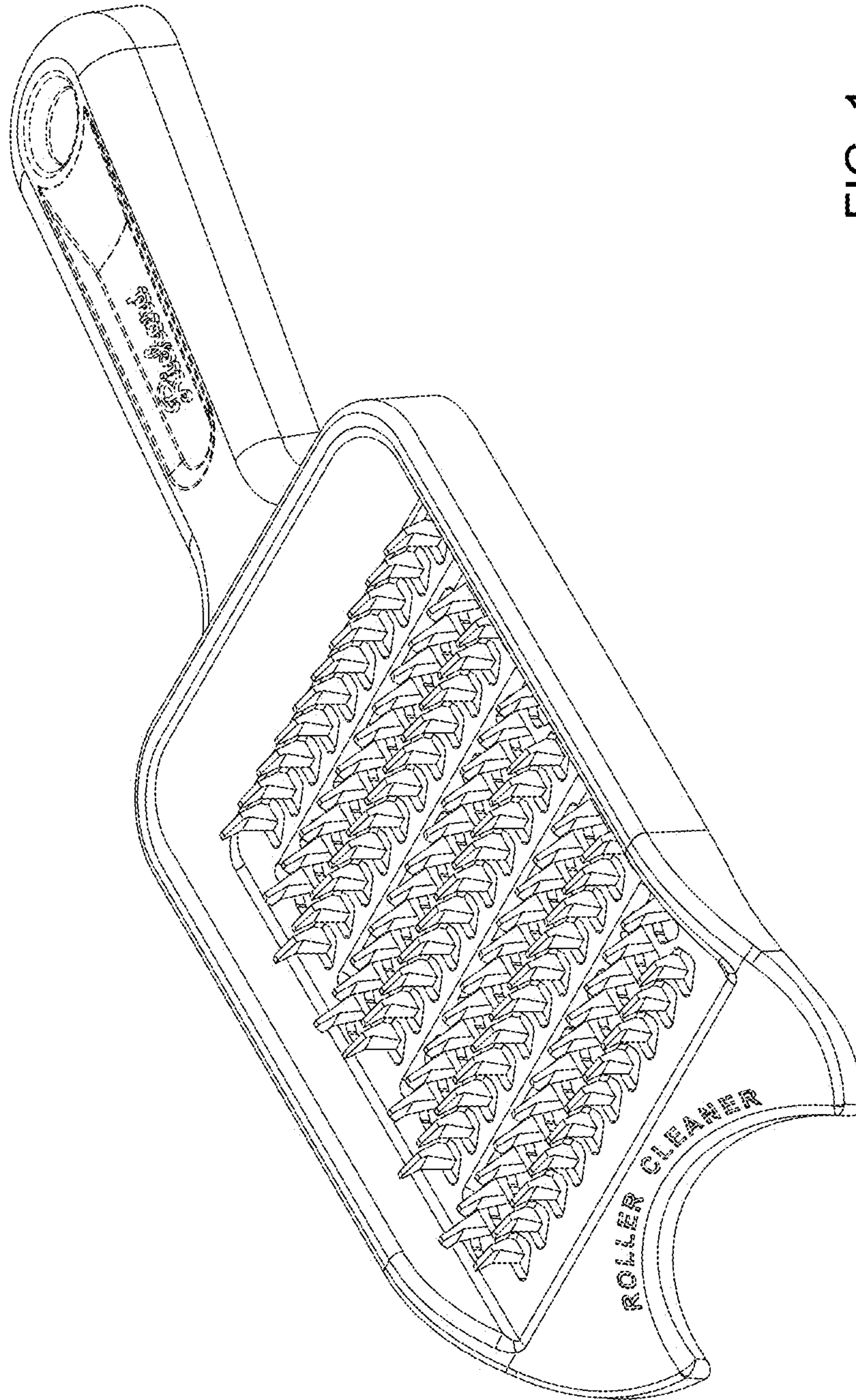

FIG. 1

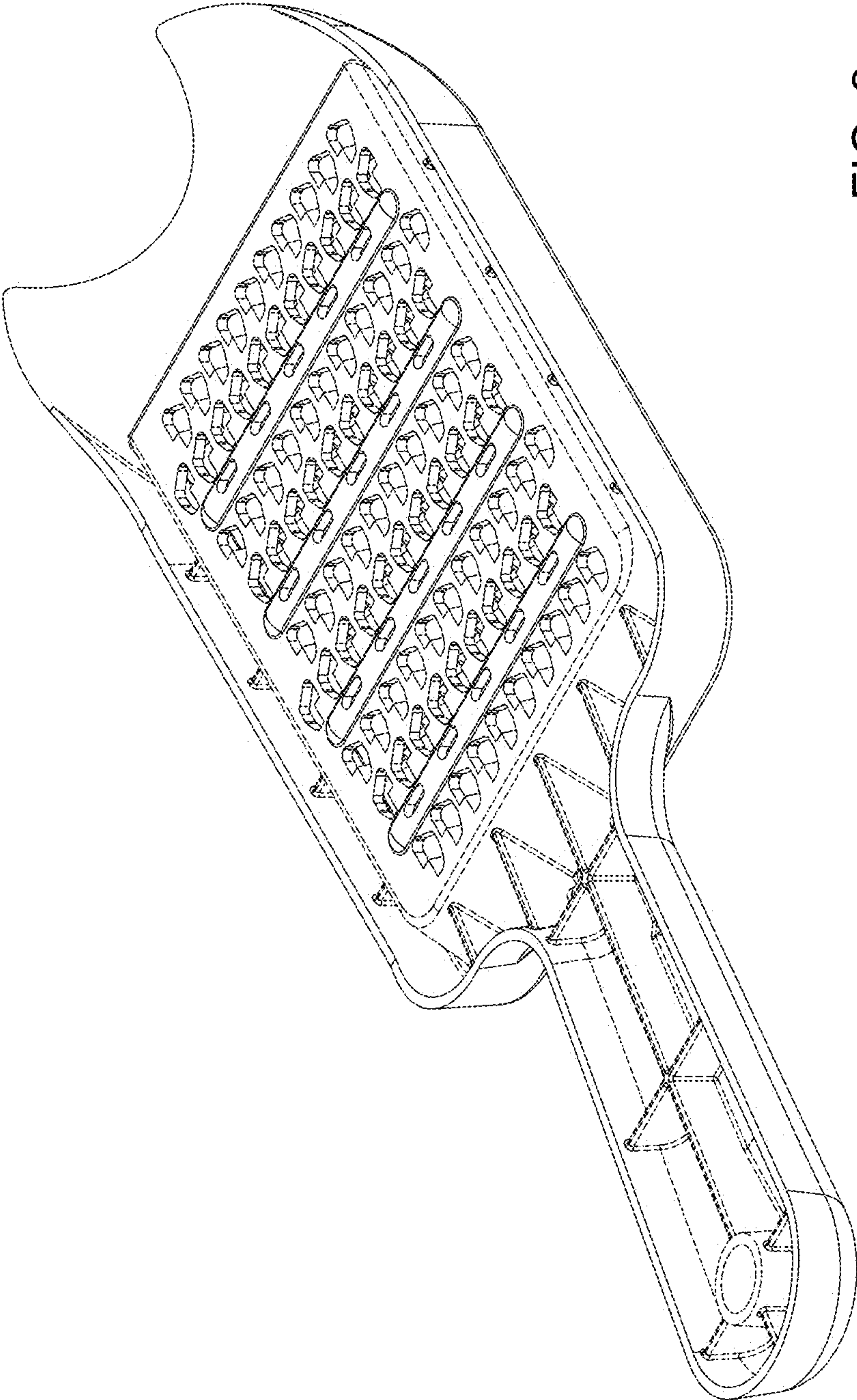

FIG. 2

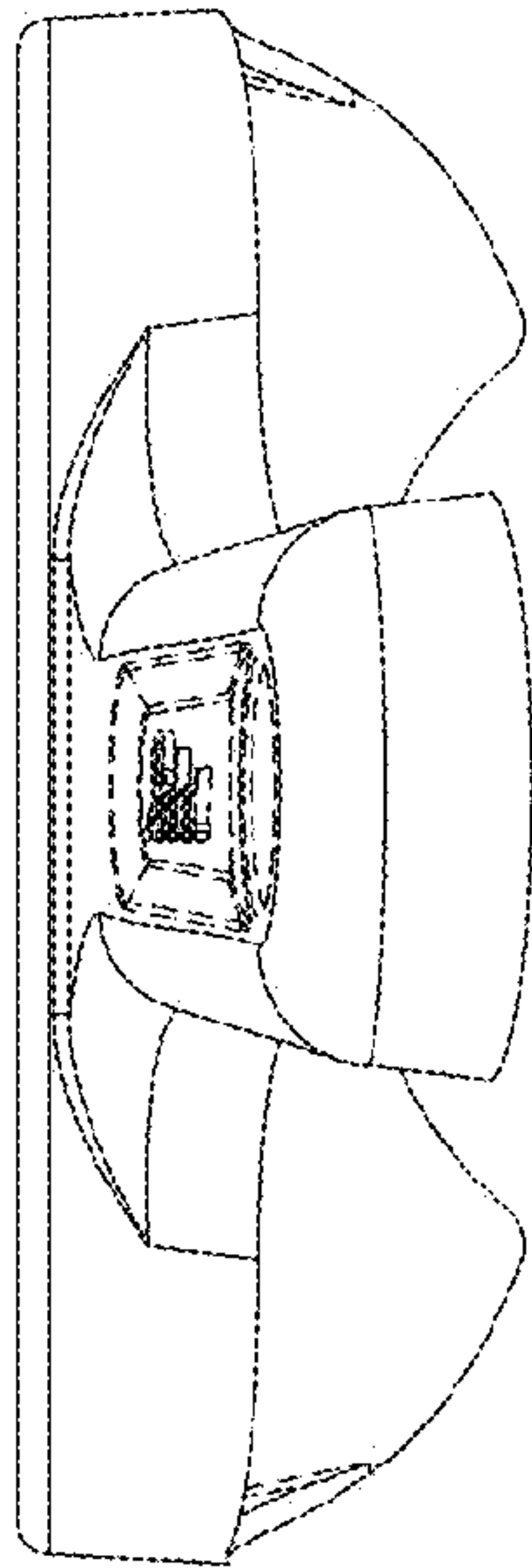

FIG. 3

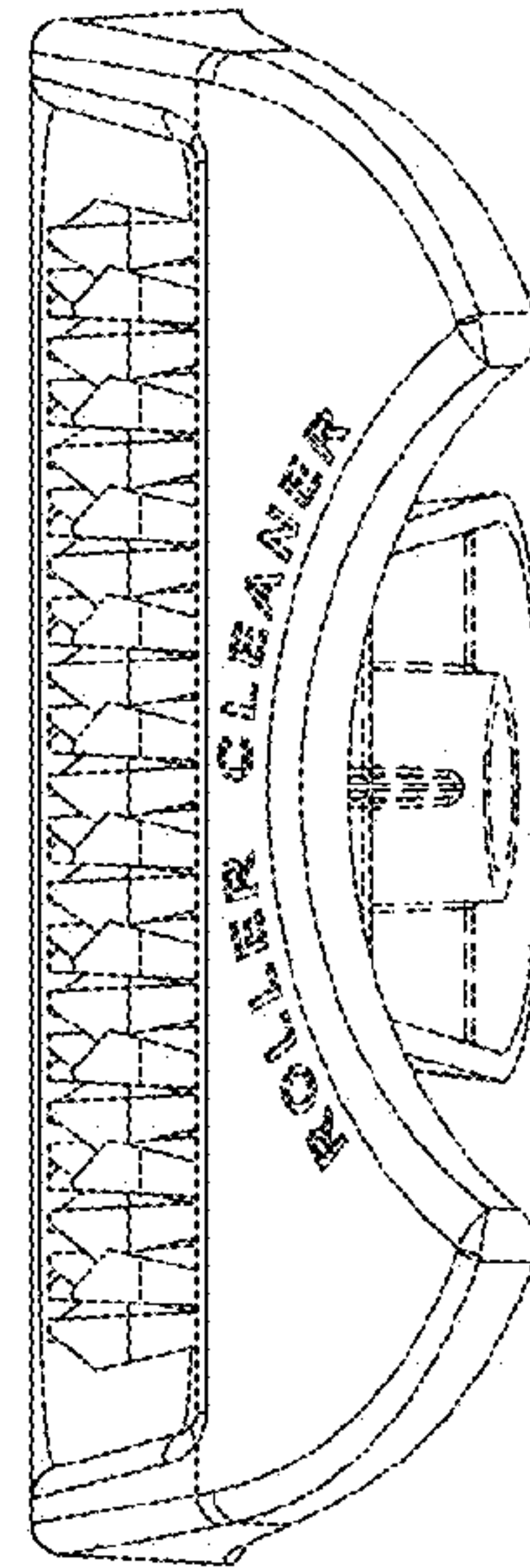

FIG. 4

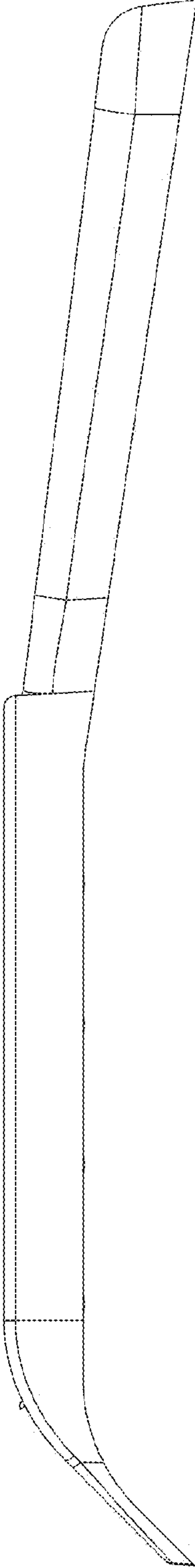

FIG. 5

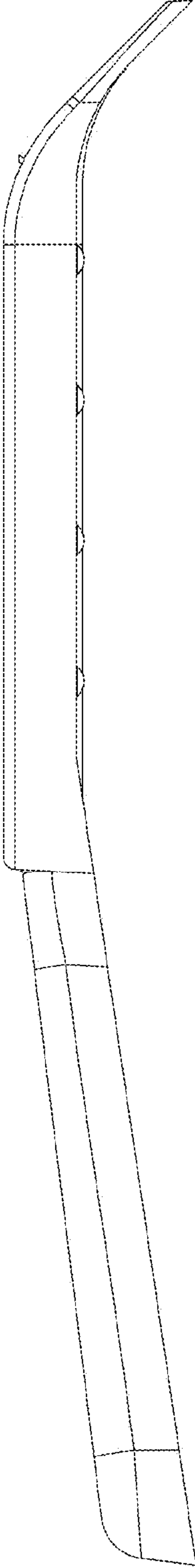

FIG. 6

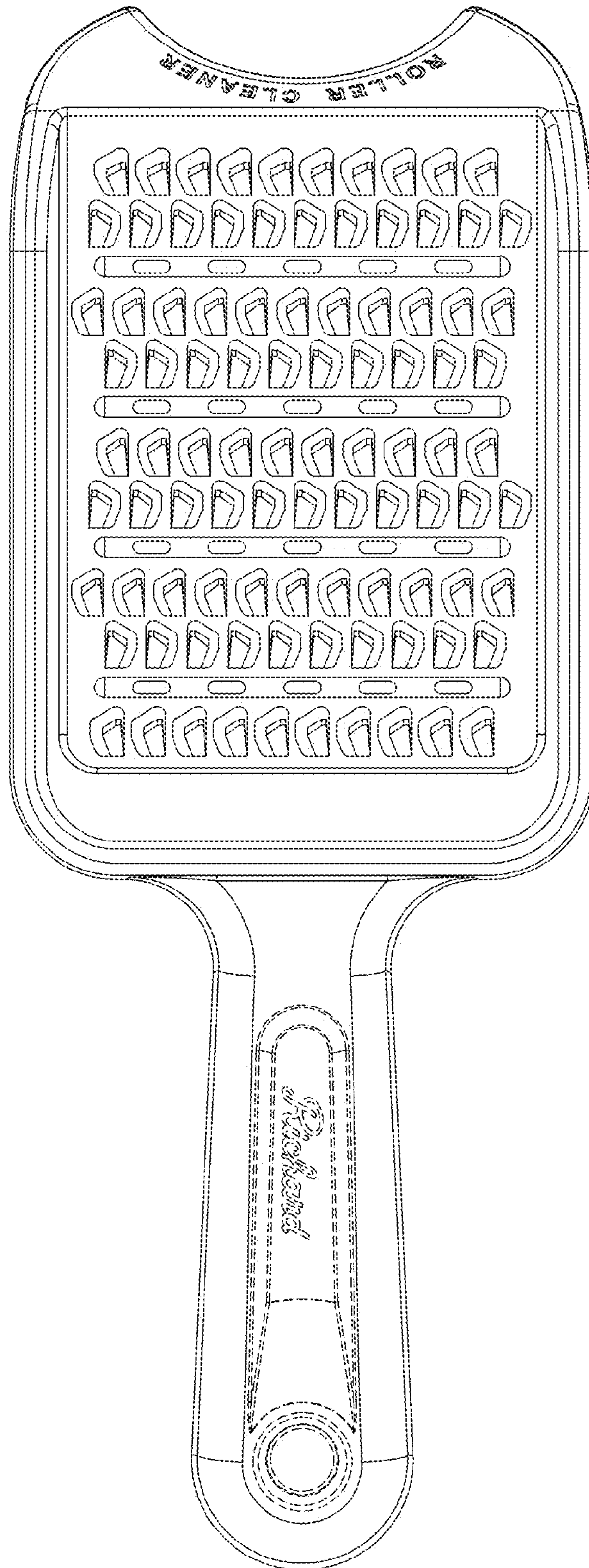

FIG. 7

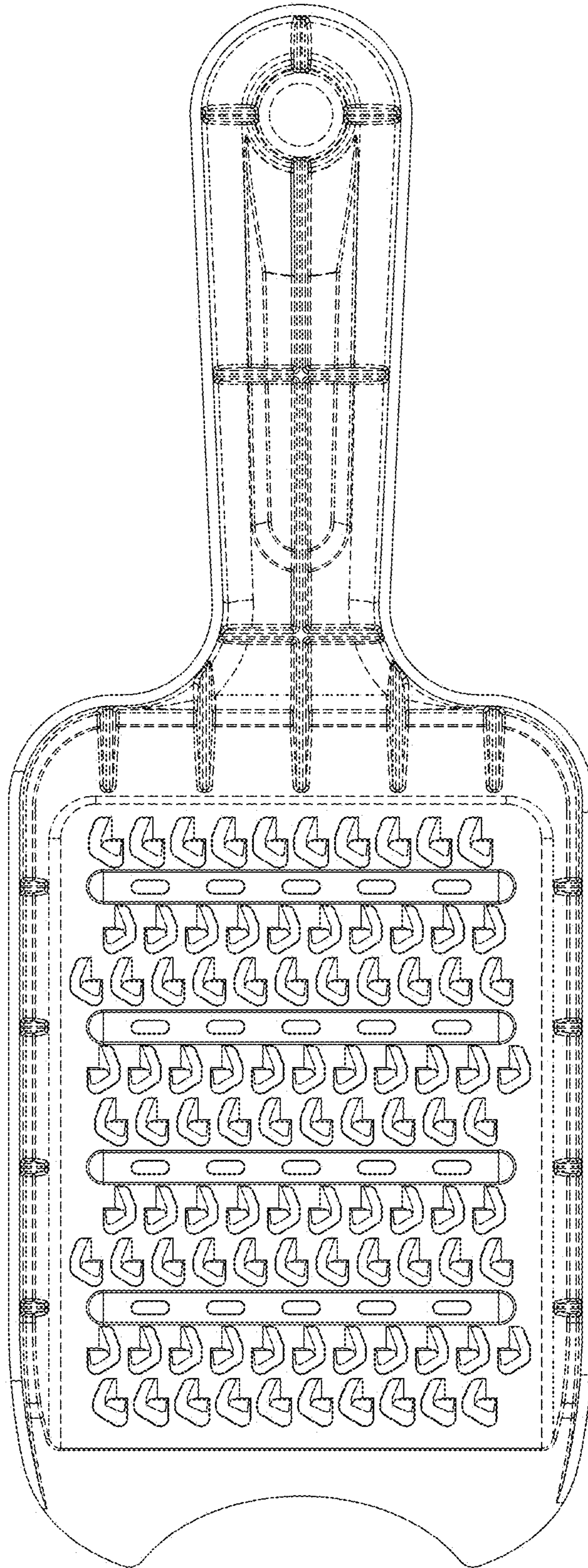

FIG. 8