



US00D712466S

(12) **United States Design Patent**  
**Nagashima et al.**

(10) **Patent No.:** **US D712,466 S**

(45) **Date of Patent:** **\*\* Sep. 2, 2014**

(54) **INK CARTRIDGE**

(71) Applicant: **Seiko Epson Corporation**, Tokyo (JP)

(72) Inventors: **Takumi Nagashima**, Shiojiri (JP); **Taku Ishizawa**, Matsumoto (JP); **Yuji Aoki**, Matsumoto (JP); **Yuki Takeda**, Fujimino (JP)

(73) Assignee: **Seiko Epson Corporation**, Tokyo (JP)

(\*\*) Term: **14 Years**

(21) Appl. No.: **29/480,823**

(22) Filed: **Jan. 30, 2014**

(30) **Foreign Application Priority Data**

Aug. 30, 2013	(JP)	.....	2013-020026
Aug. 30, 2013	(JP)	.....	2013-020027
Aug. 30, 2013	(JP)	.....	2013-020028
Aug. 30, 2013	(JP)	.....	2013-020029

(51) **LOC (10) Cl.** ..... **18-02**

(52) **U.S. Cl.**  
USPC ..... **D18/56**

(58) **Field of Classification Search**  
USPC ..... D18/12, 40, 43, 56; 399/262; 347/86, 347/87

See application file for complete search history.

(56) **References Cited**

**U.S. PATENT DOCUMENTS**

D447,169	S *	8/2001	Okubo et al.	.....	D18/56
D464,372	S *	10/2002	Yamada et al.	.....	D18/56
D464,672	S *	10/2002	Shinano et al.	.....	D18/56
D522,049	S *	5/2006	Ishizawa et al.	.....	D18/56
D524,855	S *	7/2006	Ishizawa et al.	.....	D18/56
7,448,717	B2 *	11/2008	Wanibe et al.	.....	347/86

7,938,523	B2 *	5/2011	Aldrich	.....	347/86
D656,183	S *	3/2012	Nanjo et al.	.....	D18/56
8,210,669	B2 *	7/2012	Komaki	.....	347/86
D667,491	S *	9/2012	Williamson et al.	.....	D18/56
D699,785	S *	2/2014	Harvey et al.	.....	D18/56

\* cited by examiner

*Primary Examiner* — Cathy A MacCormac

(57) **CLAIM**

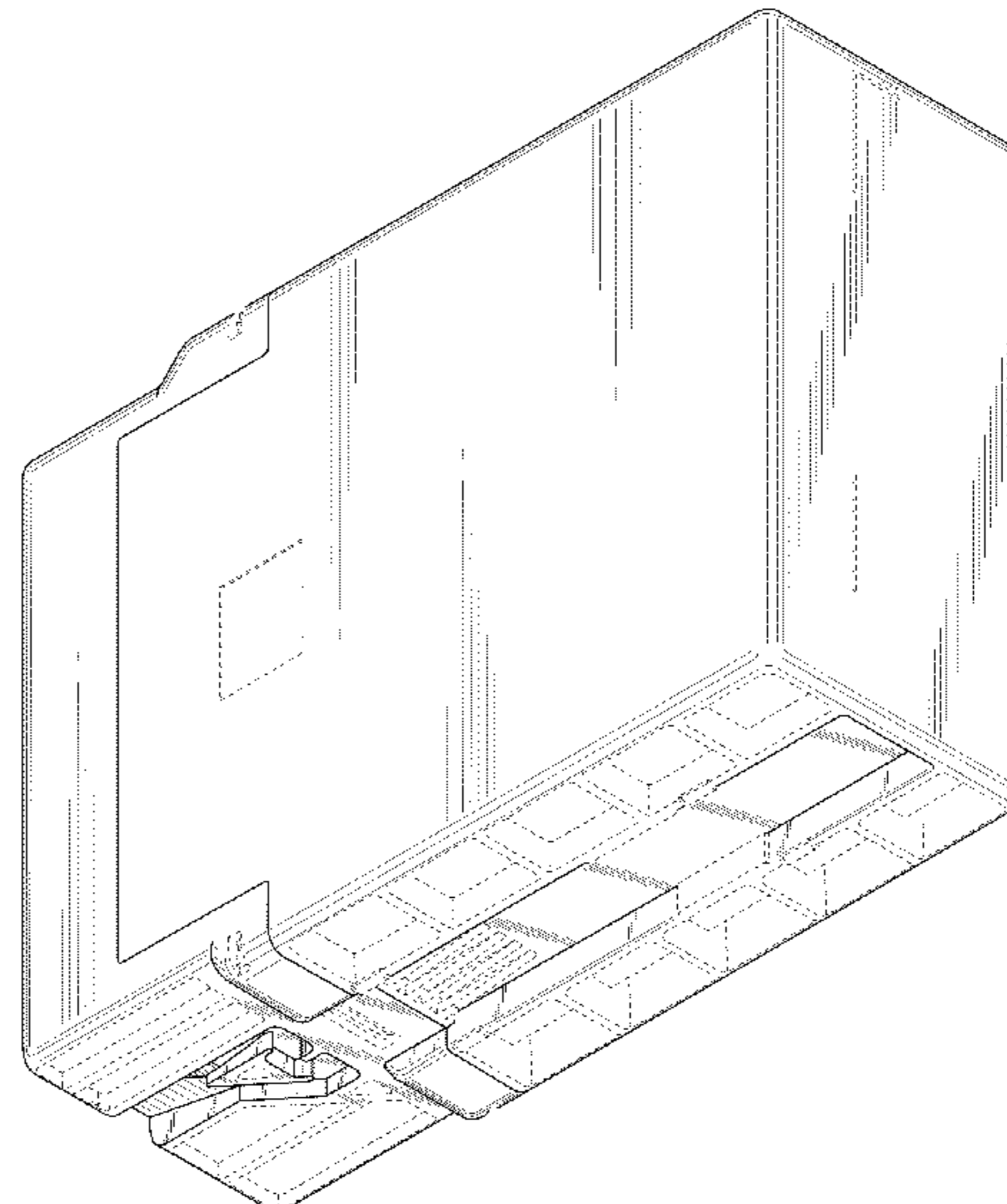
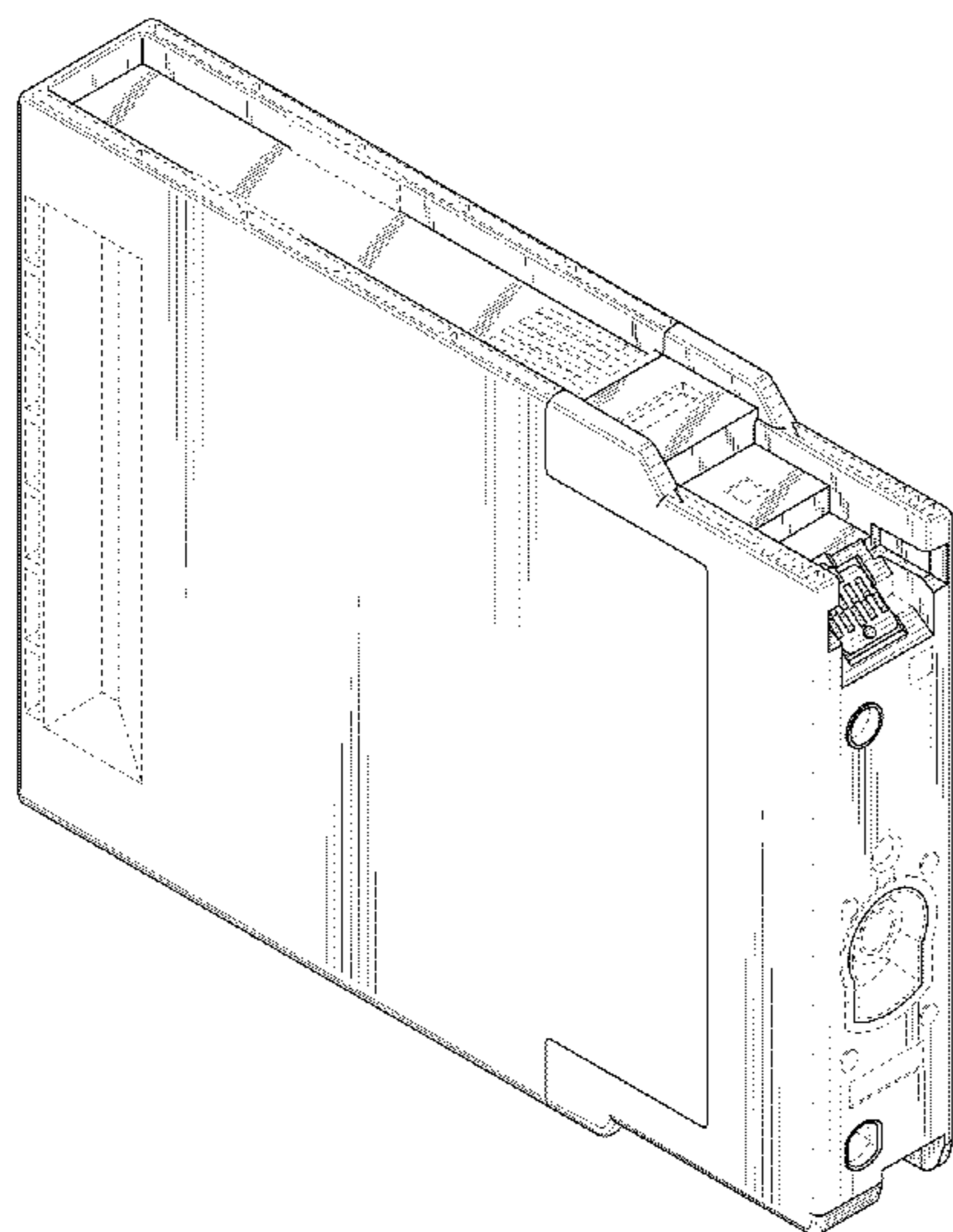
The ornamental design for an ink cartridge, as shown and described.

**DESCRIPTION**

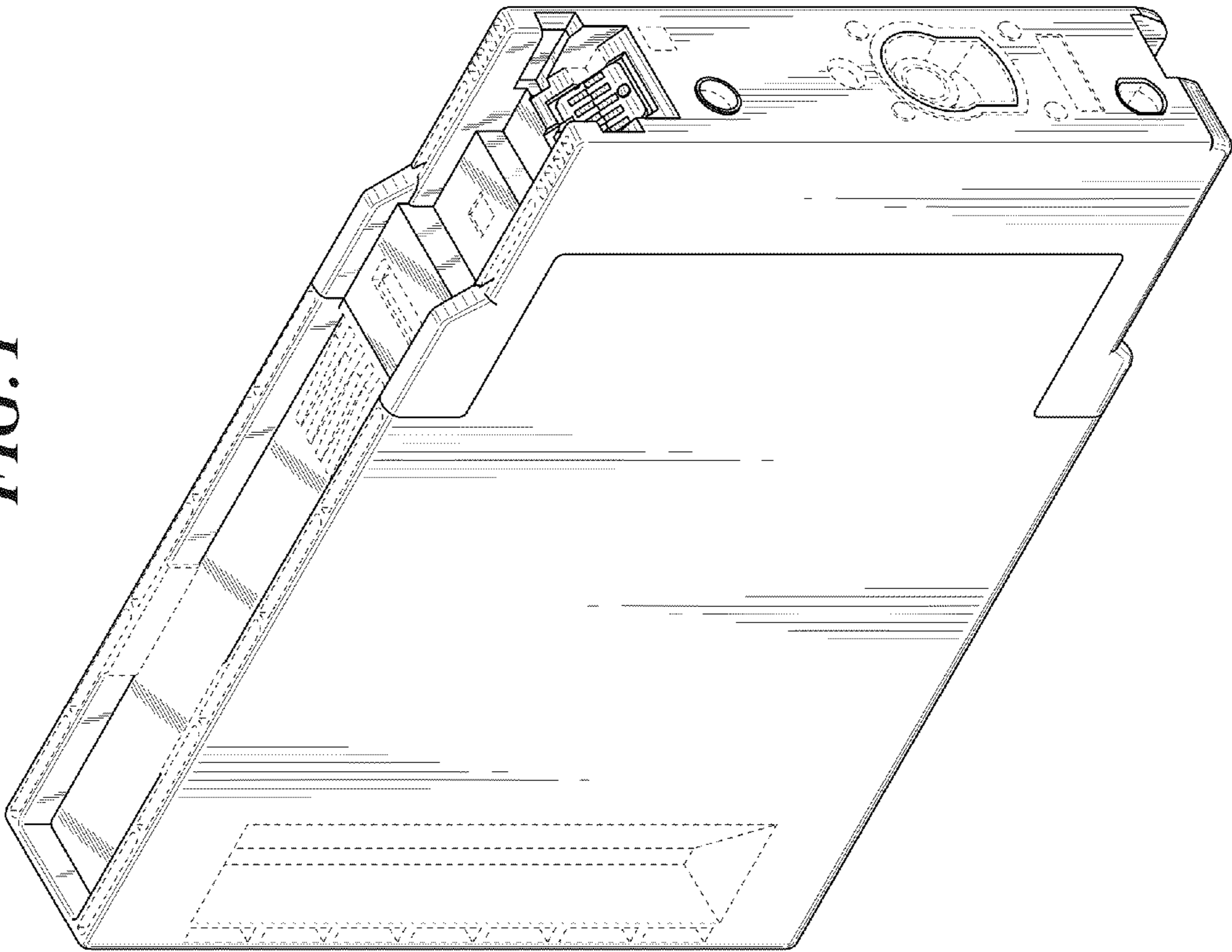
FIG. 1 is a front, top and right side perspective view of a first embodiment of an ink cartridge showing our new design; FIG. 2 is a rear, bottom and left side perspective view thereof; FIG. 3 is a front view thereof; FIG. 4 is a rear view thereof; FIG. 5 is a top plan view thereof; FIG. 6 is a bottom plan view thereof; FIG. 7 is a right side view thereof; FIG. 8 is a left side view thereof; FIG. 9 is a front, top and right side perspective view of a second embodiment of an ink cartridge showing our new design; FIG. 10 is a rear, bottom and left side perspective view thereof; FIG. 11 is a front view thereof; FIG. 12 is a rear view thereof; FIG. 13 is a top plan view thereof; FIG. 14 is a bottom plan view thereof; FIG. 15 is a right side view thereof; and, FIG. 16 is a left side view thereof.

The features shown in broken lines in the drawings depict environmental subject matter only and form no part of the claimed design. The dashed-dotted lines denote the boundary of the claim and form no part of the claimed design.

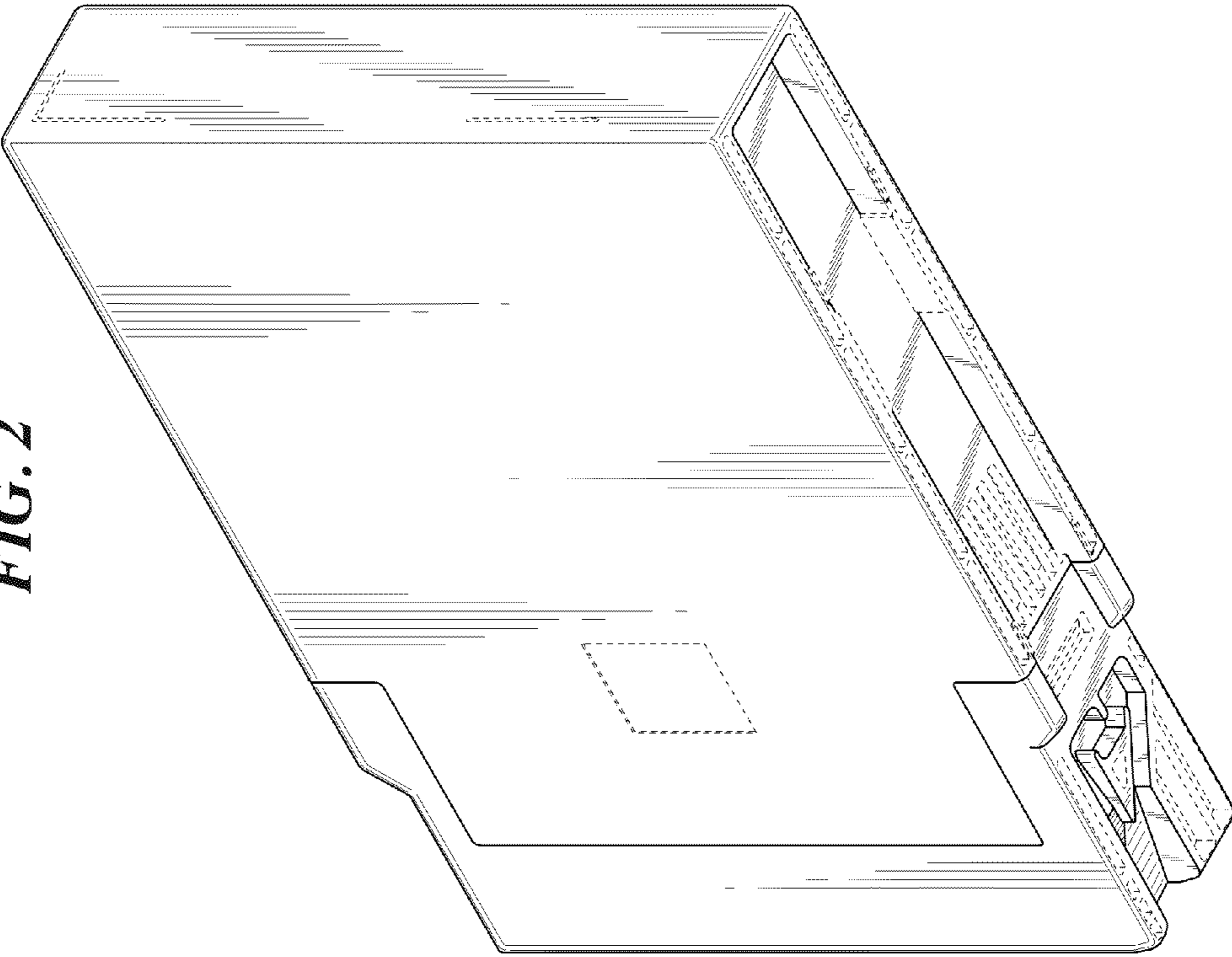
**1 Claim, 16 Drawing Sheets**



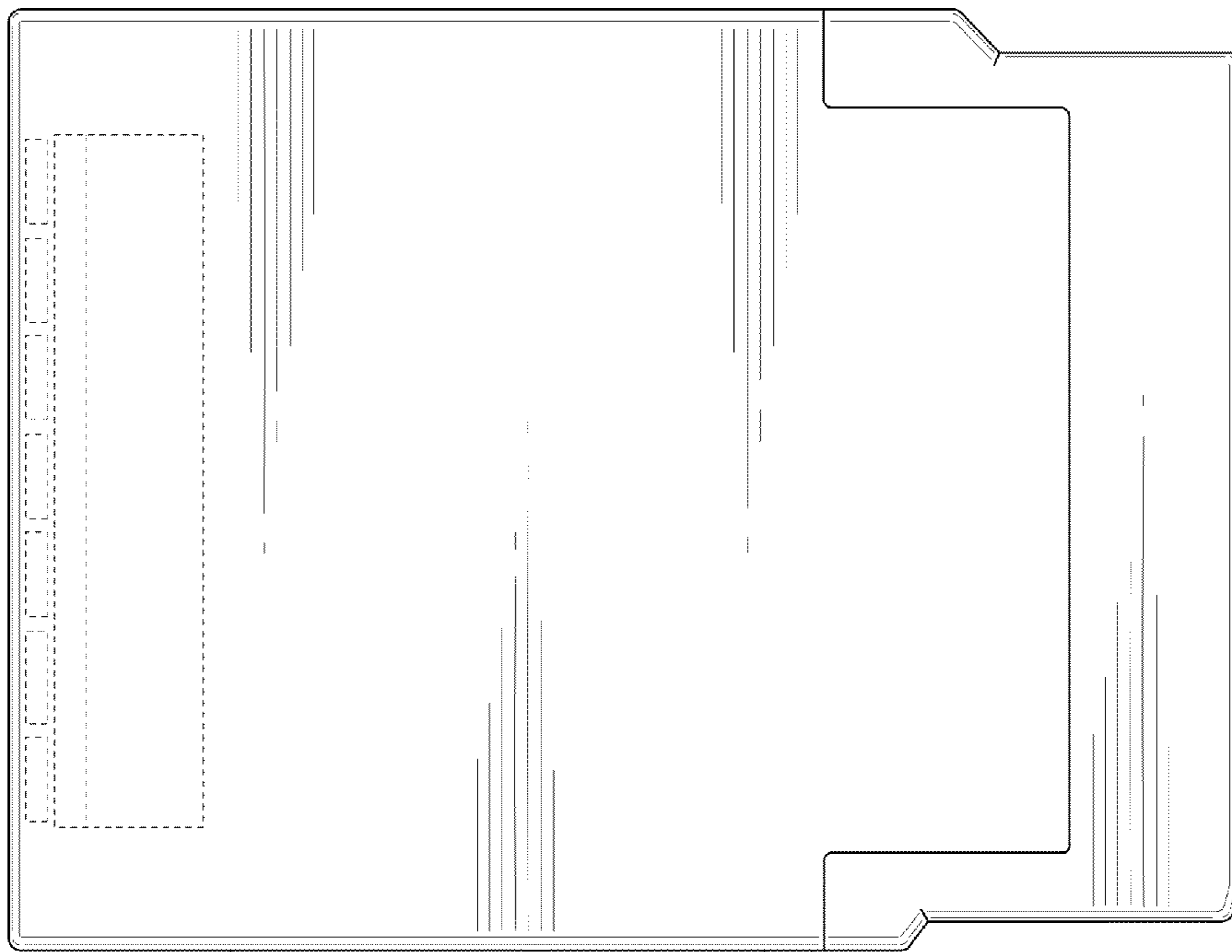
**FIG. 1**



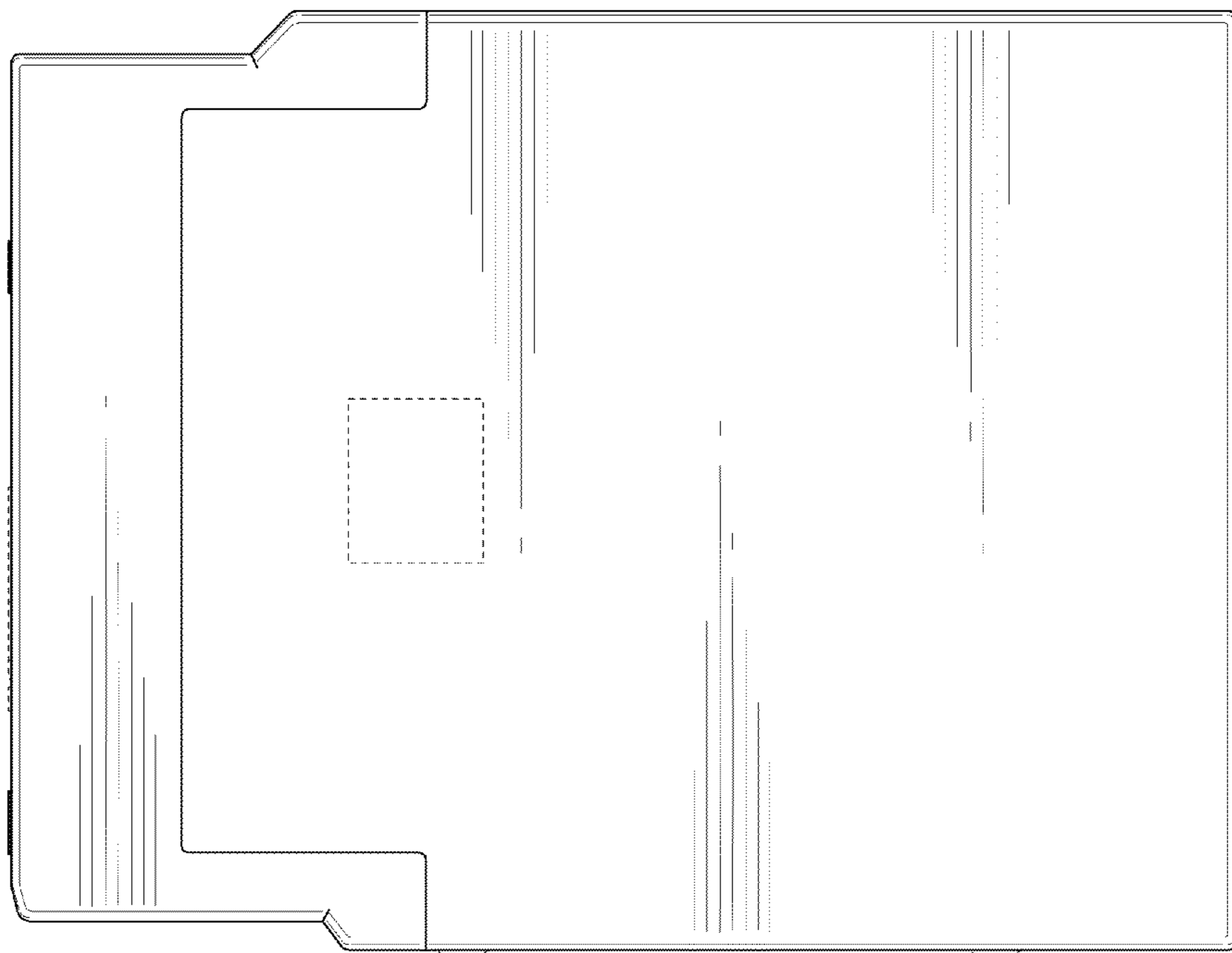
**FIG. 2**



*FIG. 3*

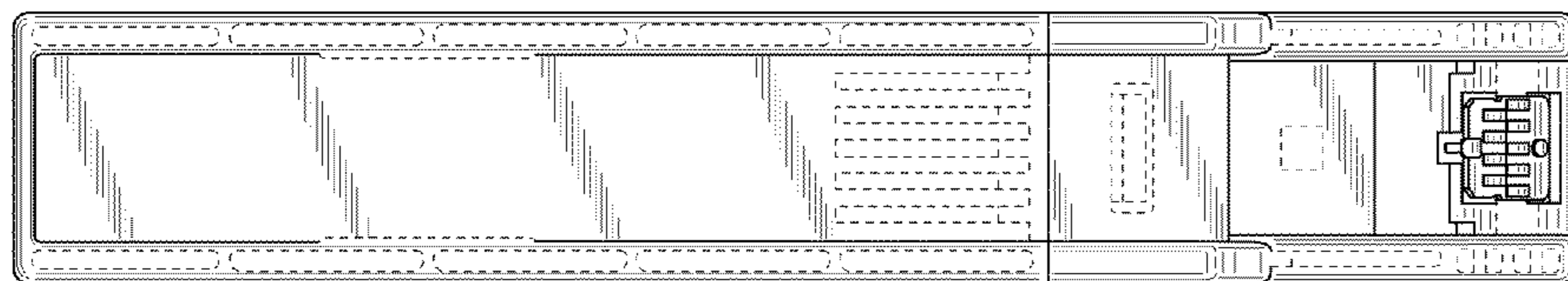


*FIG. 4*

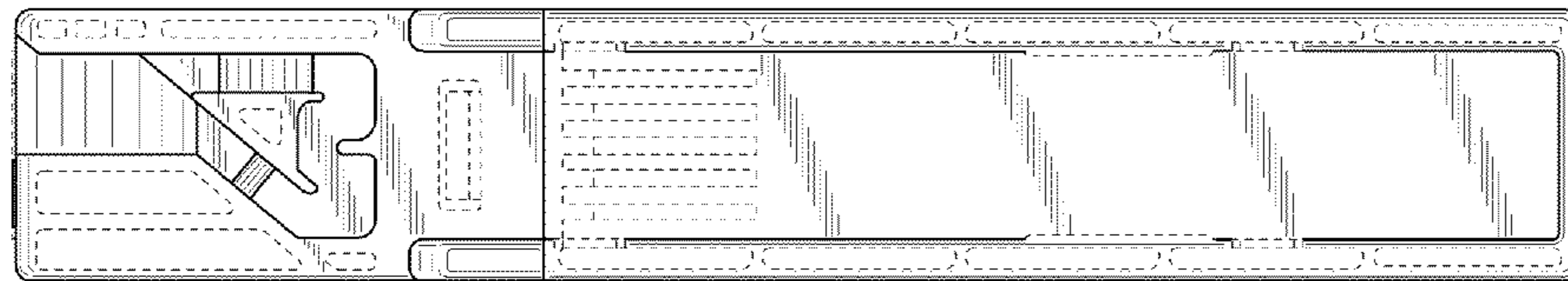




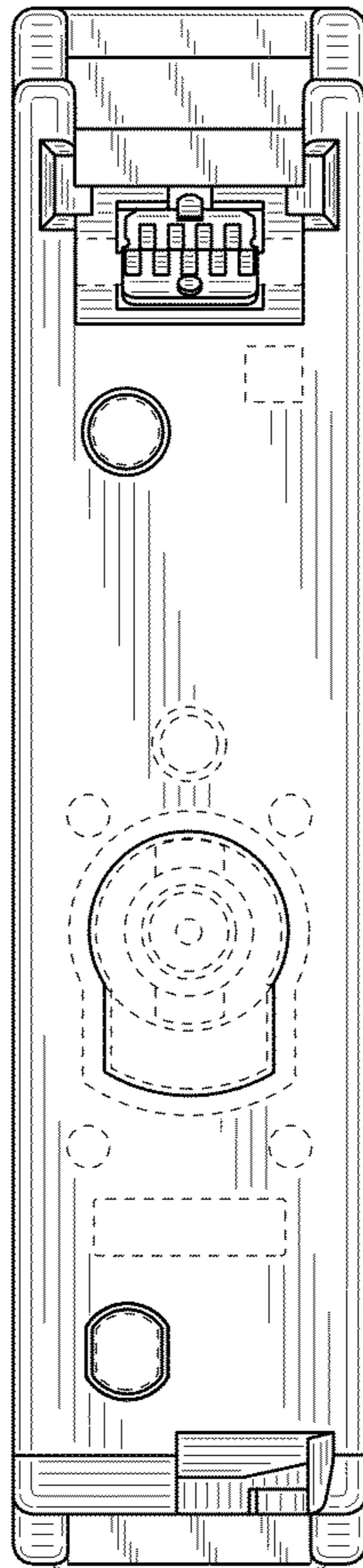
*FIG. 5*



*FIG. 6*

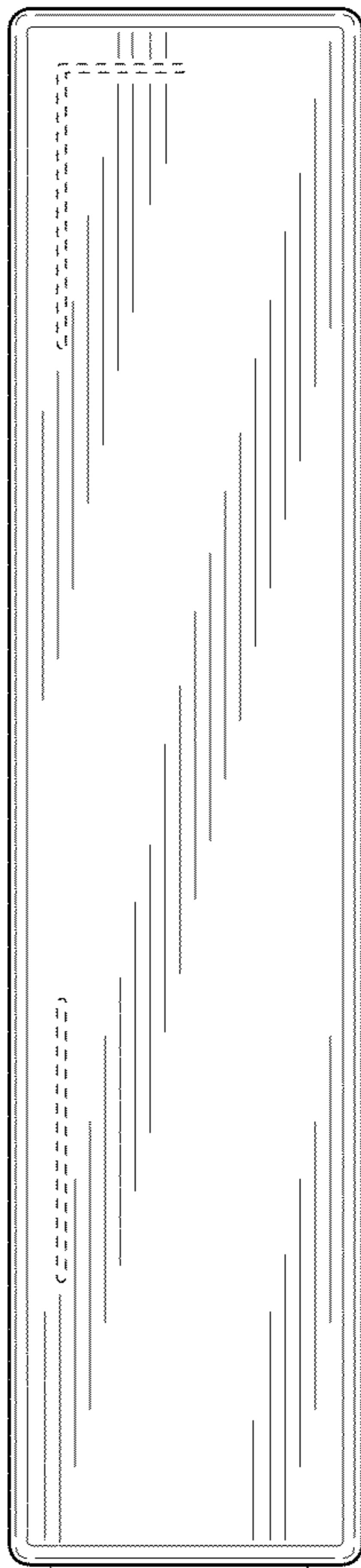


*FIG. 7*

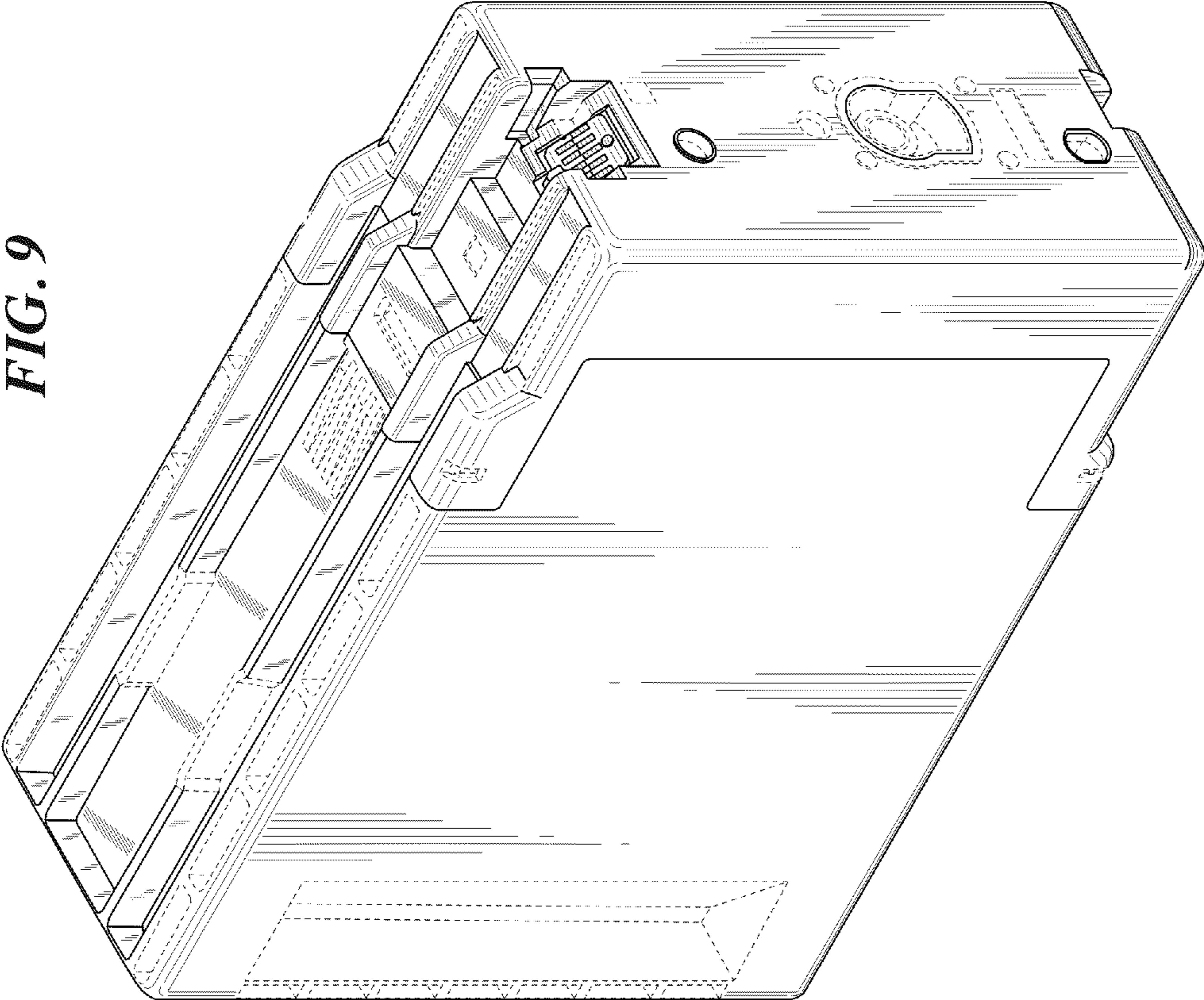


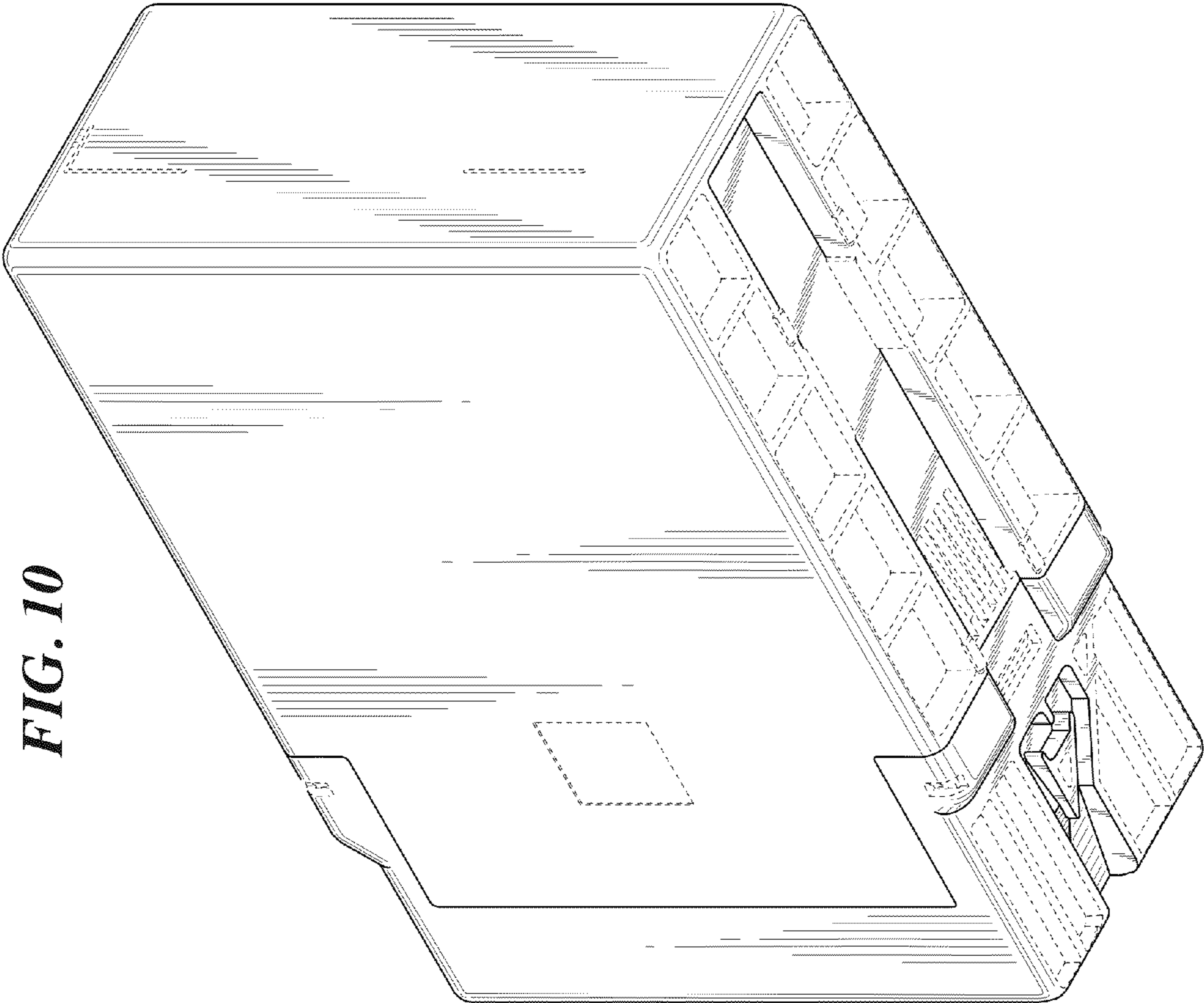


*FIG. 8*



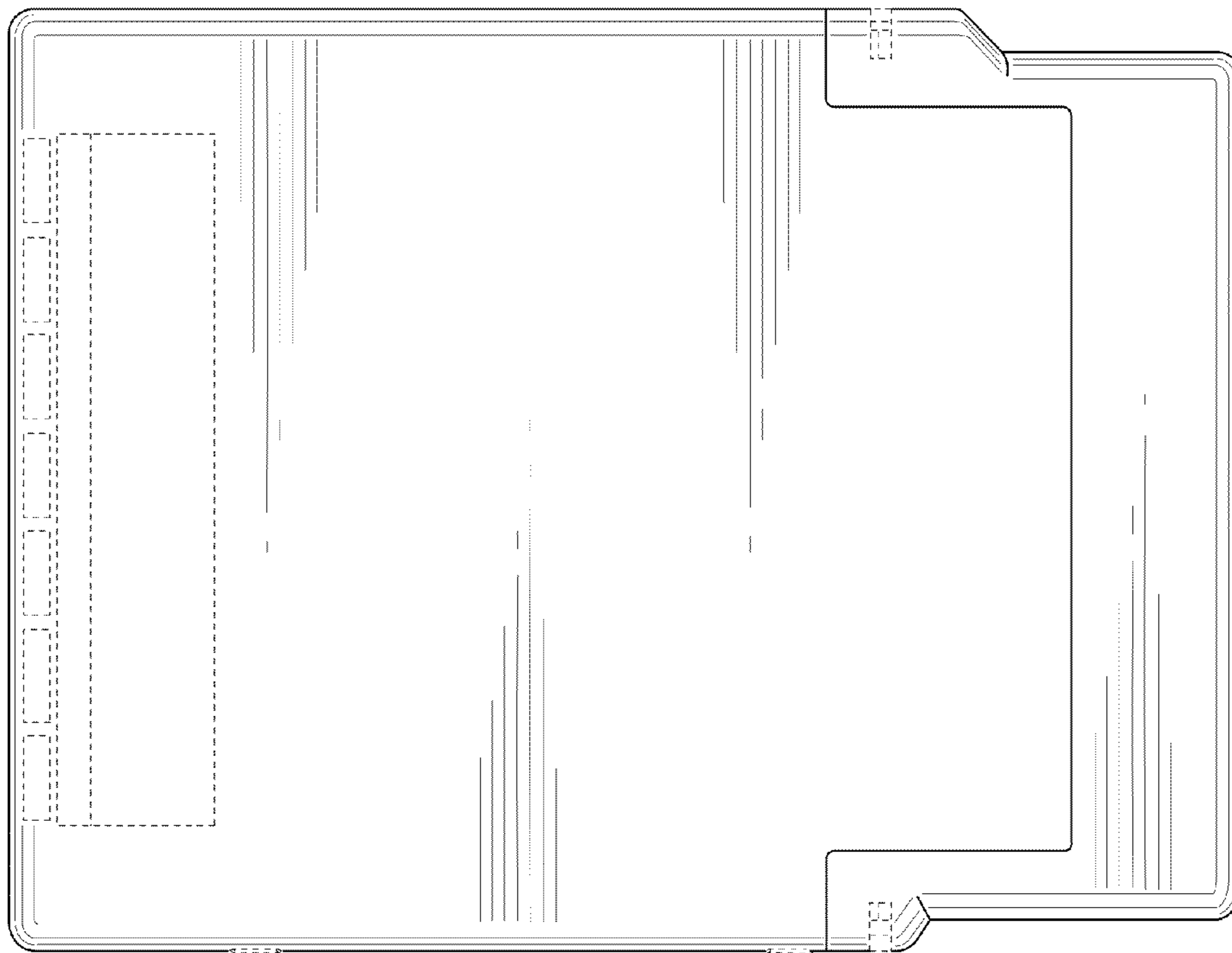
*FIG. 9*



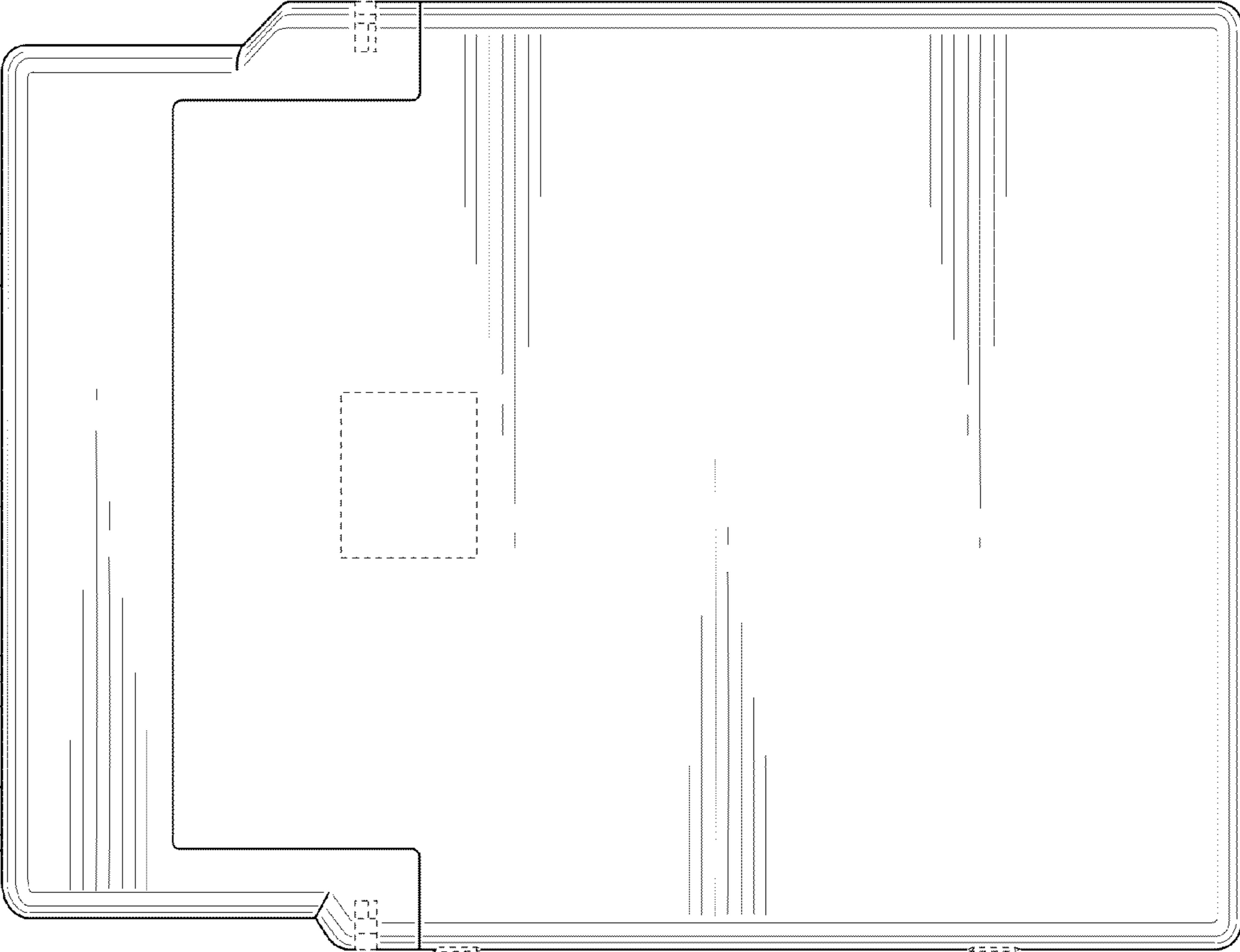


**FIG. 10**

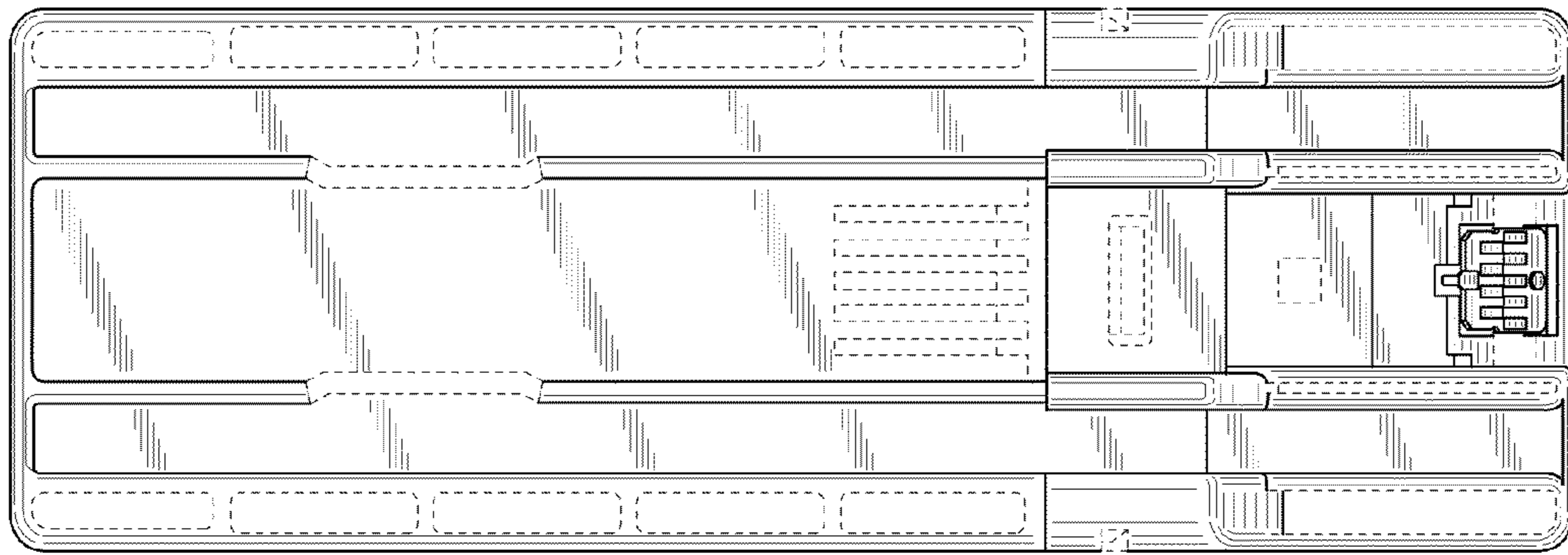
*FIG. 11*



*FIG. 12*

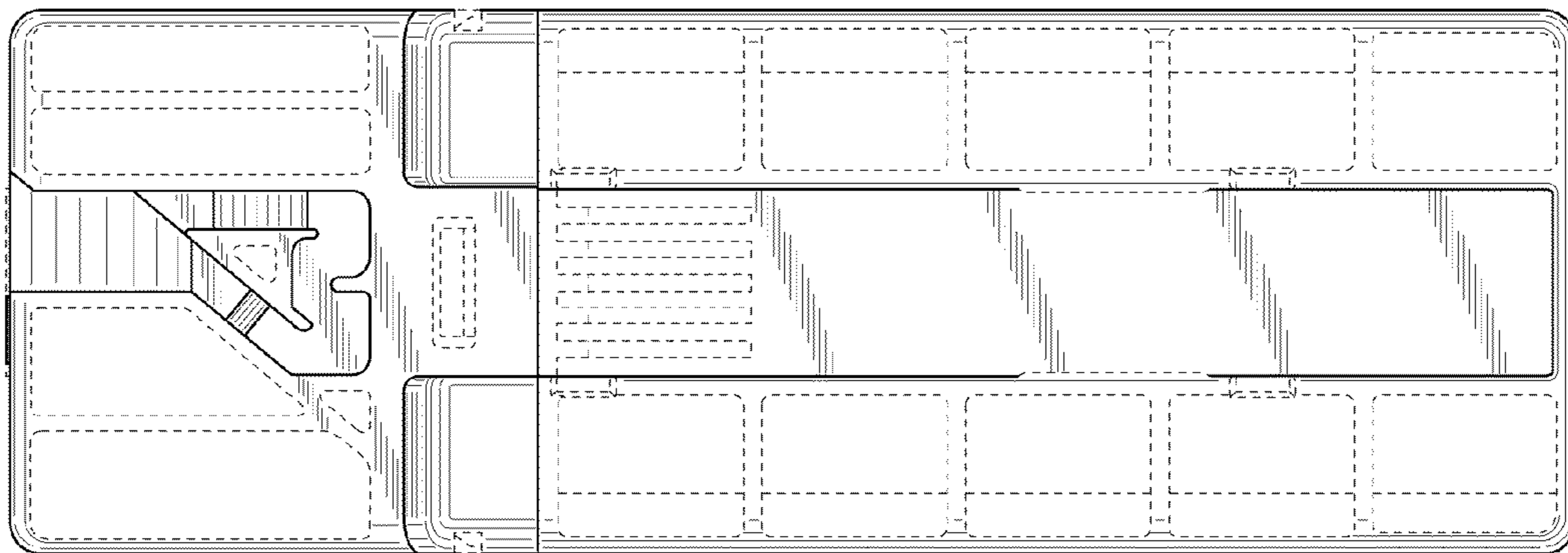


*FIG. 13*

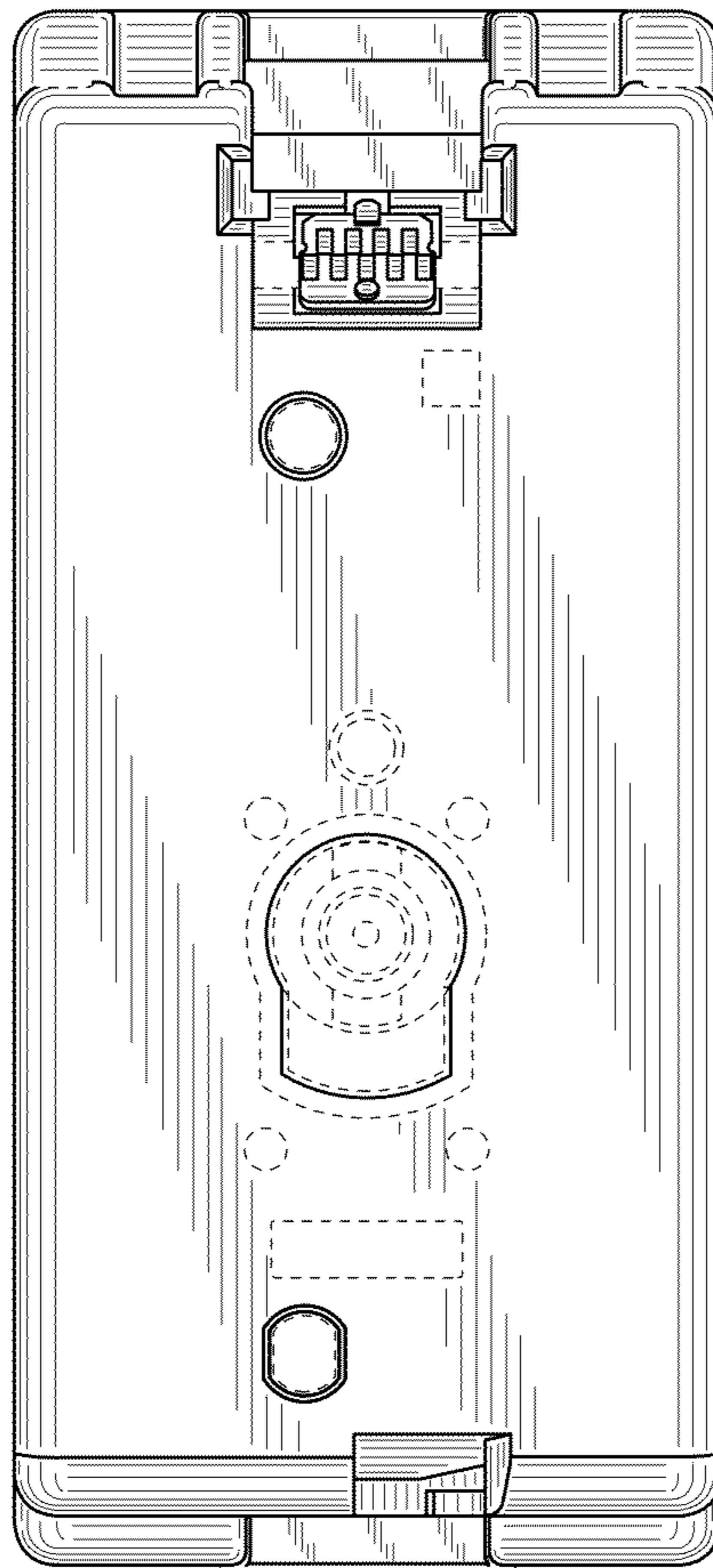




*FIG. 14*



*FIG. 15*



***FIG. 16***

