



US00D712401S

(12) **United States Design Patent**  
**Lee et al.**

(10) **Patent No.:** **US D712,401 S**  
(45) **Date of Patent:** **\*\* Sep. 2, 2014**

(54) **PORTABLE DISPLAY**

(71) Applicant: **Samsung Display Co., Ltd.**, Yongin-si (KR)

(72) Inventors: **Yong-Joon Lee**, Yongin-si (KR);  
**Woo-Jong Lee**, Yongin-si (KR)

(73) Assignee: **Samsung Display Co., Ltd.**, Yongin-si (KR)

(\*\*) Term: **14 Years**

(21) Appl. No.: **29/443,041**

(22) Filed: **Jan. 11, 2013**

(30) **Foreign Application Priority Data**

Nov. 9, 2012 (KR) ..... 30-2012-0053718

(51) **LOC (10) Cl.** ..... **14-02**

(52) **U.S. Cl.**  
USPC ..... **D14/341**

(58) **Field of Classification Search**

USPC ..... D14/341-347, 137, 138 R, 138 AA,  
D14/138 C, 138 G, 496, 203.1, 203.3, 203.4,  
D14/203.7, 129, 130, 147, 218, 248, 389,  
D14/388, 426, 420; D10/65, 104.1;  
D18/6-7; D21/324, 329, 330;  
455/556.1, 556.2, 566, 575.1, 90.3;  
379/433.04, 433.01, 433.06, 916;  
345/173, 901, 905; 361/679.26, 679.3,  
361/679.55, 679.56

See application file for complete search history.

(56) **References Cited**

**U.S. PATENT DOCUMENTS**

D580,928 S \* 11/2008 Bemelmans et al. .... D14/345  
D585,444 S \* 1/2009 Verschoor ..... D14/345  
7,639,237 B2 \* 12/2009 Perkins ..... 345/168  
D628,569 S \* 12/2010 Guo ..... D14/341  
8,009,421 B2 \* 8/2011 Misawa ..... 361/679.55  
8,009,422 B2 \* 8/2011 Misawa ..... 361/679.55  
D656,137 S \* 3/2012 Chung et al. .... D14/341

D658,173 S \* 4/2012 Kim ..... D14/345  
D659,693 S \* 5/2012 TerMeer et al. .... D14/342  
D664,144 S \* 7/2012 Akana et al. .... D14/389  
2007/0241002 A1 \* 10/2007 Wu et al. .... 206/150  
2011/0018785 A1 \* 1/2011 Aoki ..... 345/1.3

**FOREIGN PATENT DOCUMENTS**

KR 1020120014872 2/2012  
WO WO2012020983 A2 2/2012

**OTHER PUBLICATIONS**

Polymer vision, Philips, URLhttp://www.google.co.kr/imgres?imgurl=http://images.gizmag.com/hero/4523\_2090530342.jpg&imgrefurl=http://www.gizmag.com/go/4523/&usg=\_\_SxRK:QFvDTLyTazZ\_9snYx\_ukSw=&h=298&w=530&sz=94&hl=ko&start=9&zoom=1&fbid=O:fJJubgOuPeM:&tbnh=74&tbnw=132&ei=8q5yULD7POJPmAWpioCQBw&prev=/search%3Fq%3Drollable%2Band%2Bdisplay%26hl%3Dko%26newwindow%3D1%26sa%3DX%26gbv%3D2%26tbn%3Disch%26prmd%3Divsul&atbs=1, 4 pgs.

\* cited by examiner

*Primary Examiner* — Barbara Fox

(74) *Attorney, Agent, or Firm* — Christie, Parker & Hale, LLP

(57) **CLAIM**

The ornamental design for a portable display, as shown and described.

**DESCRIPTION**

FIG. 1 is a front perspective view of a portable display showing the new design;  
FIG. 2 is a front view thereof;  
FIG. 3 is a rear view thereof;  
FIG. 4 is a right side view thereof;  
FIG. 5 is a left side view thereof;  
FIG. 6 is a top view thereof;  
FIG. 7 is a bottom view thereof; and,  
FIG. 8 is a front perspective view thereof in an unrolled state.  
The broken lines in the drawings are for illustrative purpose only and form no part of the claimed design.

**1 Claim, 7 Drawing Sheets**

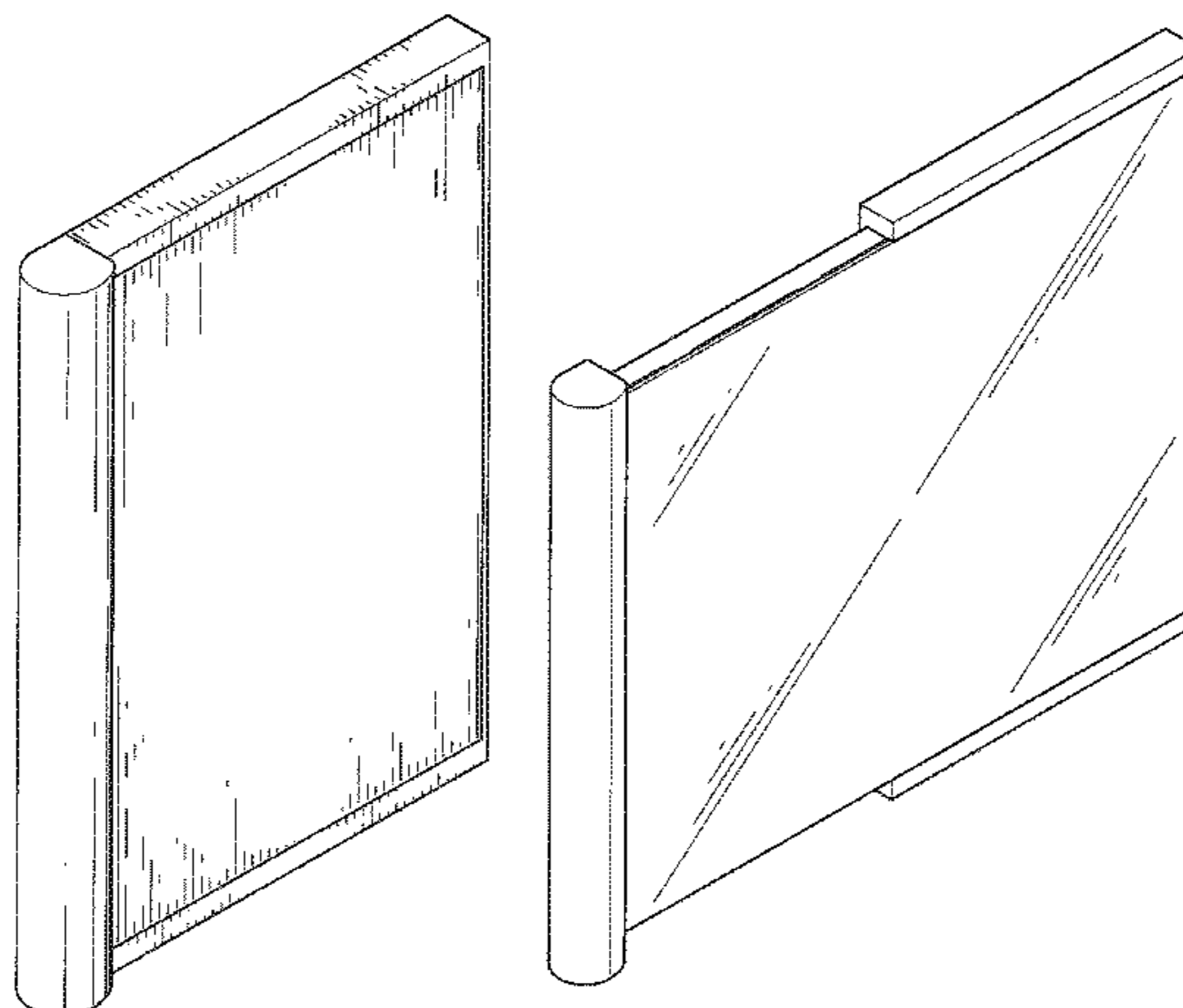

FIG. 1

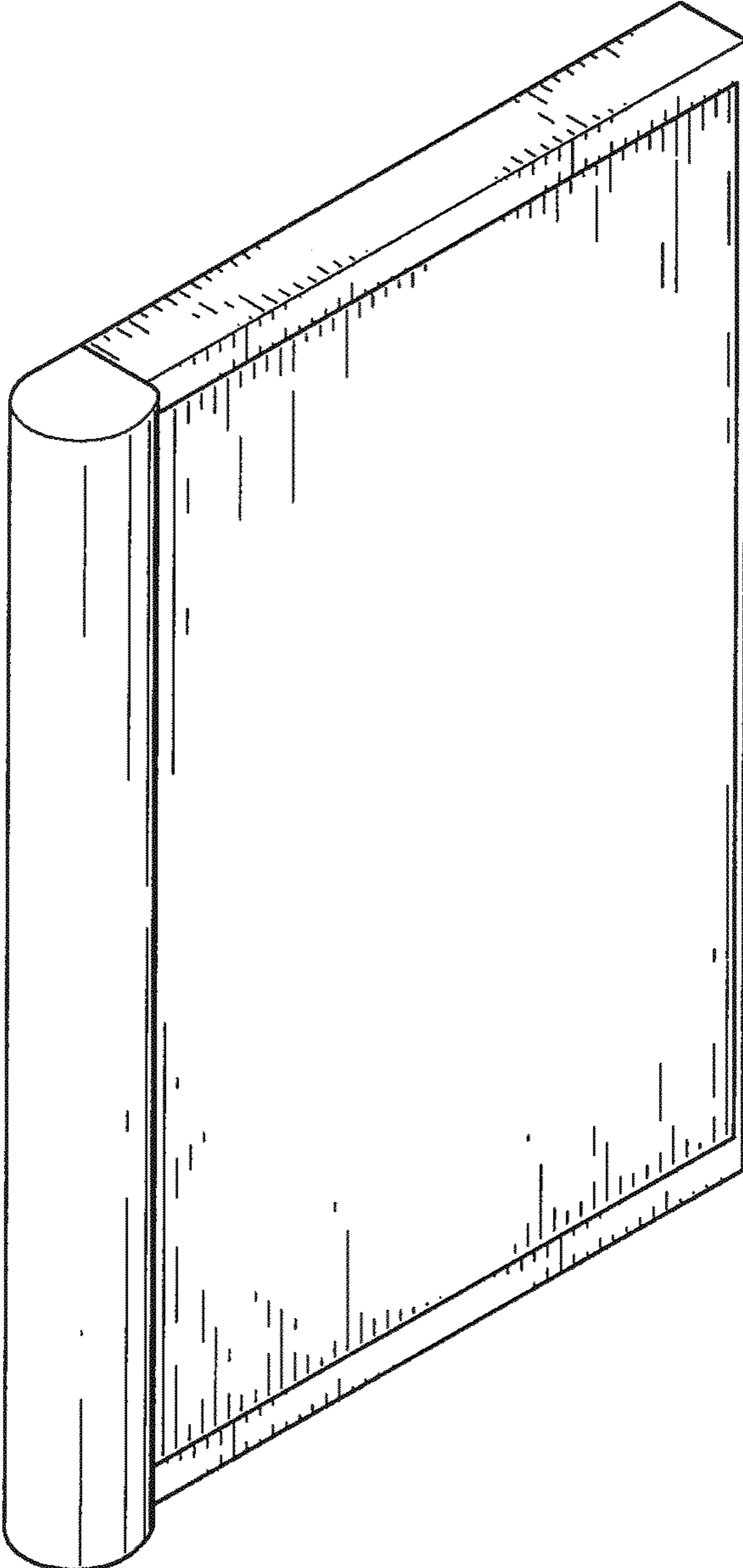

FIG. 2

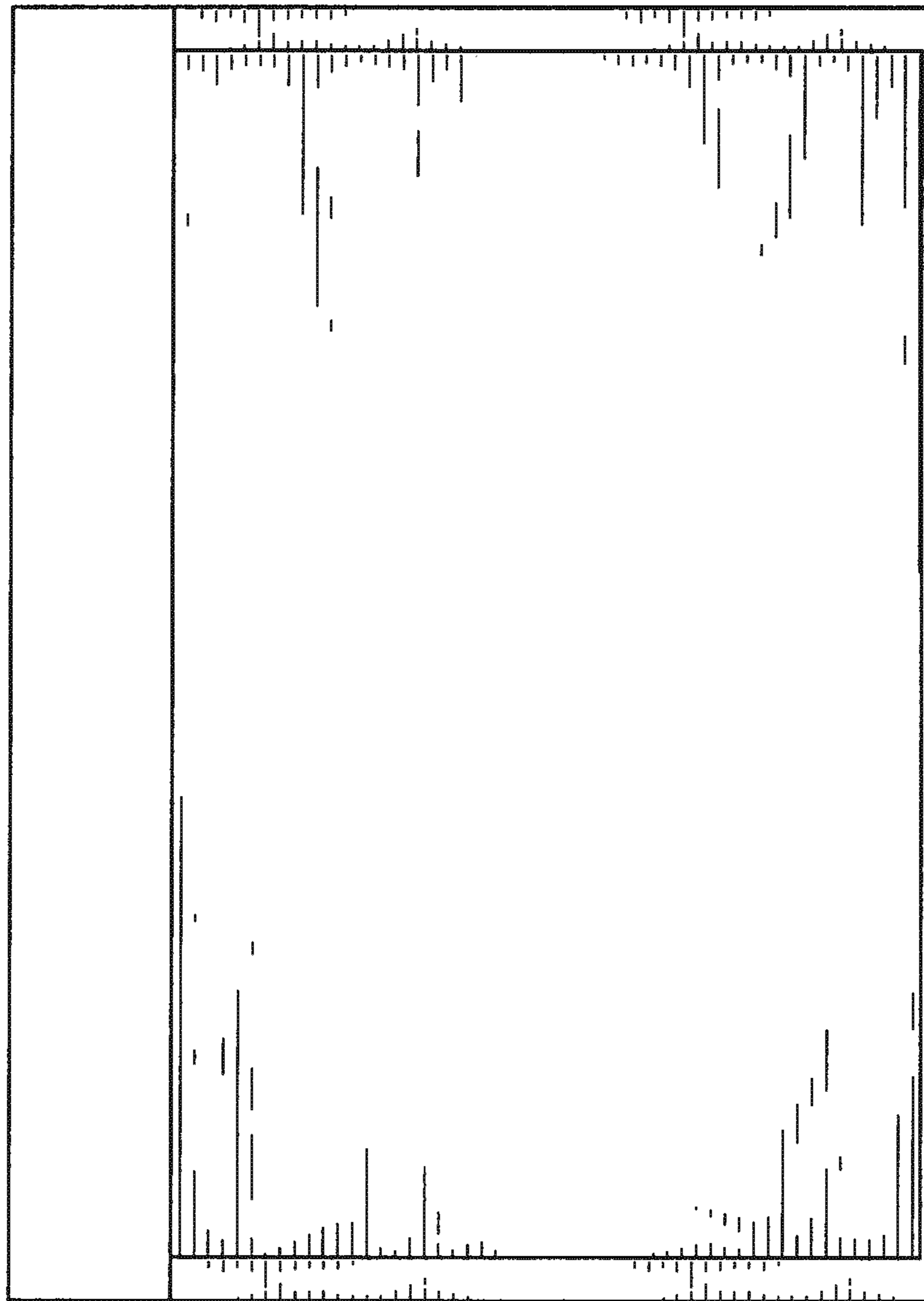

FIG. 3

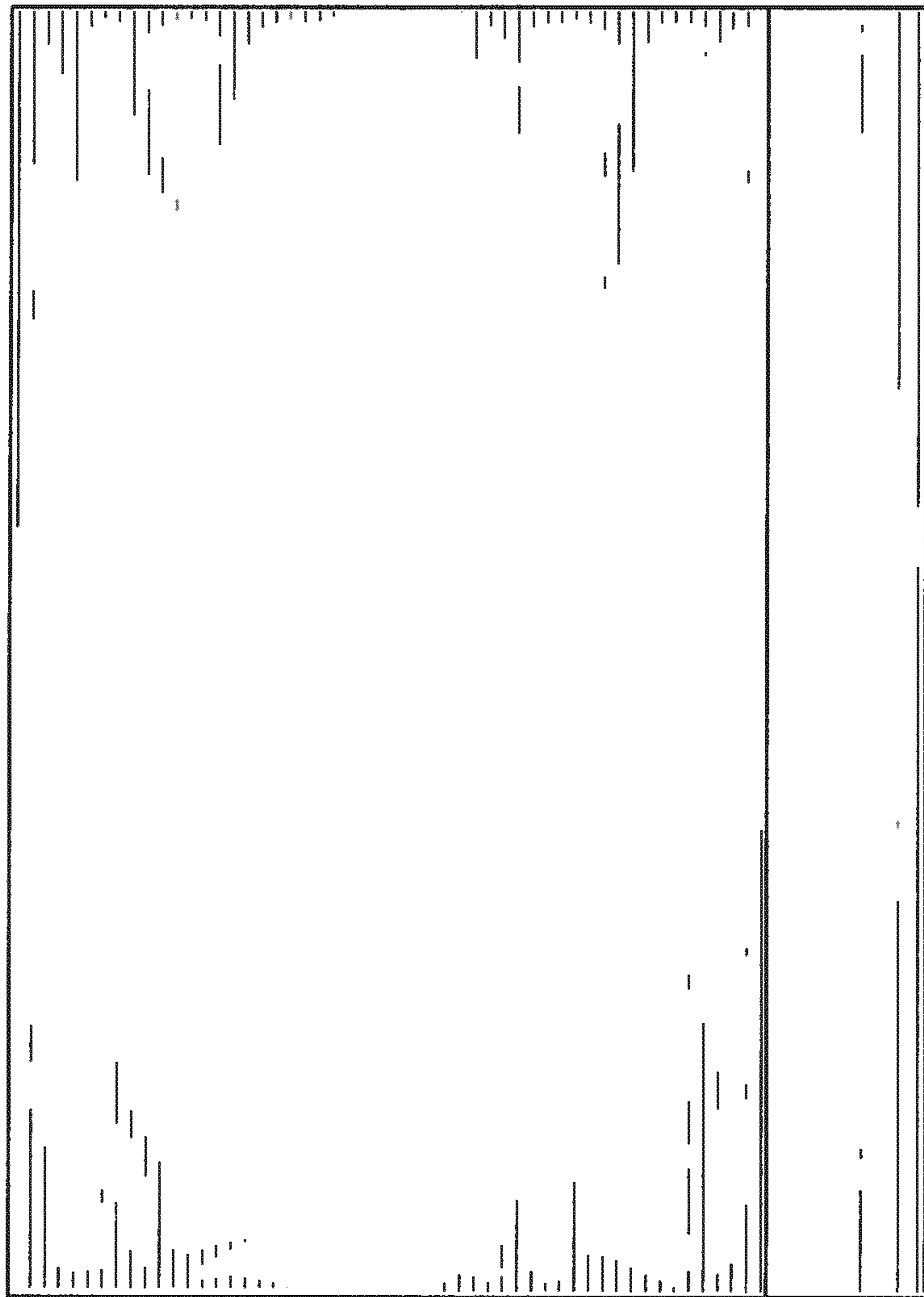

FIG. 4

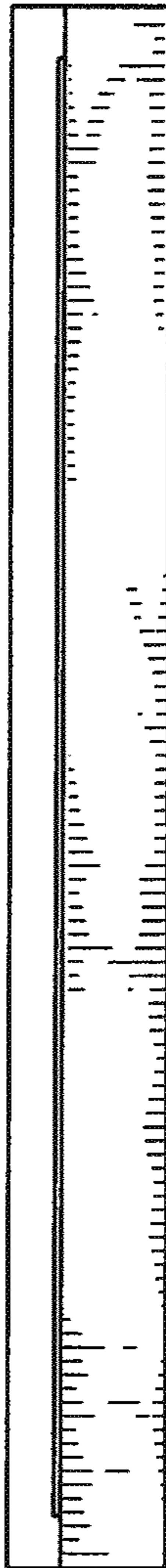

FIG. 5

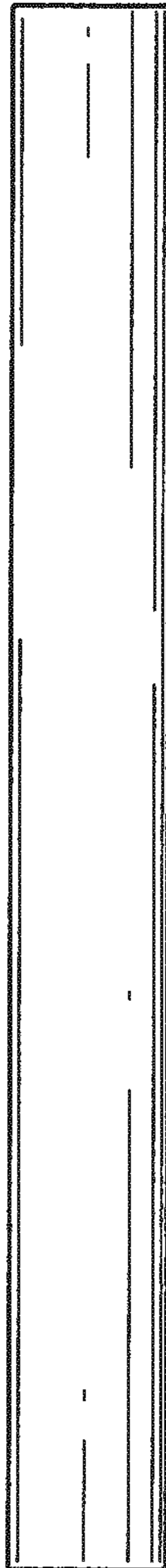

FIG. 6

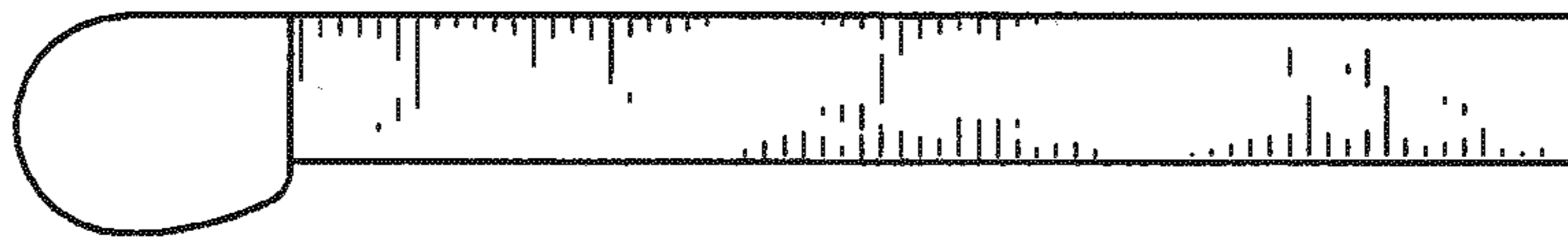

FIG. 7

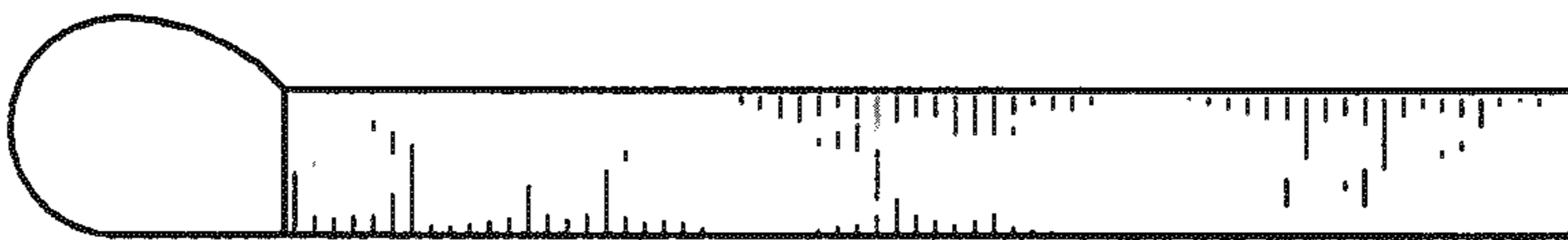

FIG. 8

