



US00D712348S

(12) **United States Design Patent**
Zhang

(10) **Patent No.:** **US D712,348 S**
(45) **Date of Patent:** **** Sep. 2, 2014**

- (54) **BATTERY PACK**
- (71) Applicant: **Chervon (HK) Limited**, Wanchai (HK)
- (72) Inventor: **Su Zhang**, Nanjing (CN)
- (73) Assignee: **Chervon (HK) Limited**, Hong Kong (HK)
- (**) Term: **14 Years**
- (21) Appl. No.: **29/473,767**
- (22) Filed: **Nov. 26, 2013**

D504,659 S *	5/2005	Voli et al.	D13/103
D623,126 S *	9/2010	Contreras	D13/103
D663,264 S *	7/2012	London	D13/103
D686,569 S *	7/2013	Lau	D13/103
D694,176 S *	11/2013	Buetow et al.	D13/103
D698,313 S *	1/2014	Buetow et al.	D13/119

* cited by examiner

Primary Examiner — Rosemary K Tarcza

(74) *Attorney, Agent, or Firm* — Greenberg Traurig, LLP

(30) **Foreign Application Priority Data**

May 31, 2013 (CN) 2013 3 0220472

(51) **LOC (10) Cl.** **13-02**

(52) **U.S. Cl.**
USPC **D13/103**

(58) **Field of Classification Search**
USPC D13/102–104, 107–108, 110, 118–121,
D13/184, 199; 429/96–100, 163, 176
See application file for complete search history.

(56) **References Cited**

U.S. PATENT DOCUMENTS

D320,379 S *	10/1991	Culbertson	D13/103
D478,608 S *	8/2003	Briks et al.	D16/237

(57) **CLAIM**

What is claimed is the ornamental design for a battery pack, as shown and described.

DESCRIPTION

FIG. 1 is a top plan view of a battery pack showing the new design;

FIG. 2 is a bottom plan view thereof;

FIG. 3 is a left side elevational view thereof;

FIG. 4 is a right side elevational view thereof;

FIG. 5 is a rear side elevational view thereof;

FIG. 6 is a front side elevational view thereof; and,

FIG. 7 is a perspective view thereof.

Any elements shown in dotted and/or dashed lines are provided for illustrative purposes only and form no part of the design claimed. Any surface shading is used solely to show the character or contour of the surfaces represented.

1 Claim, 6 Drawing Sheets

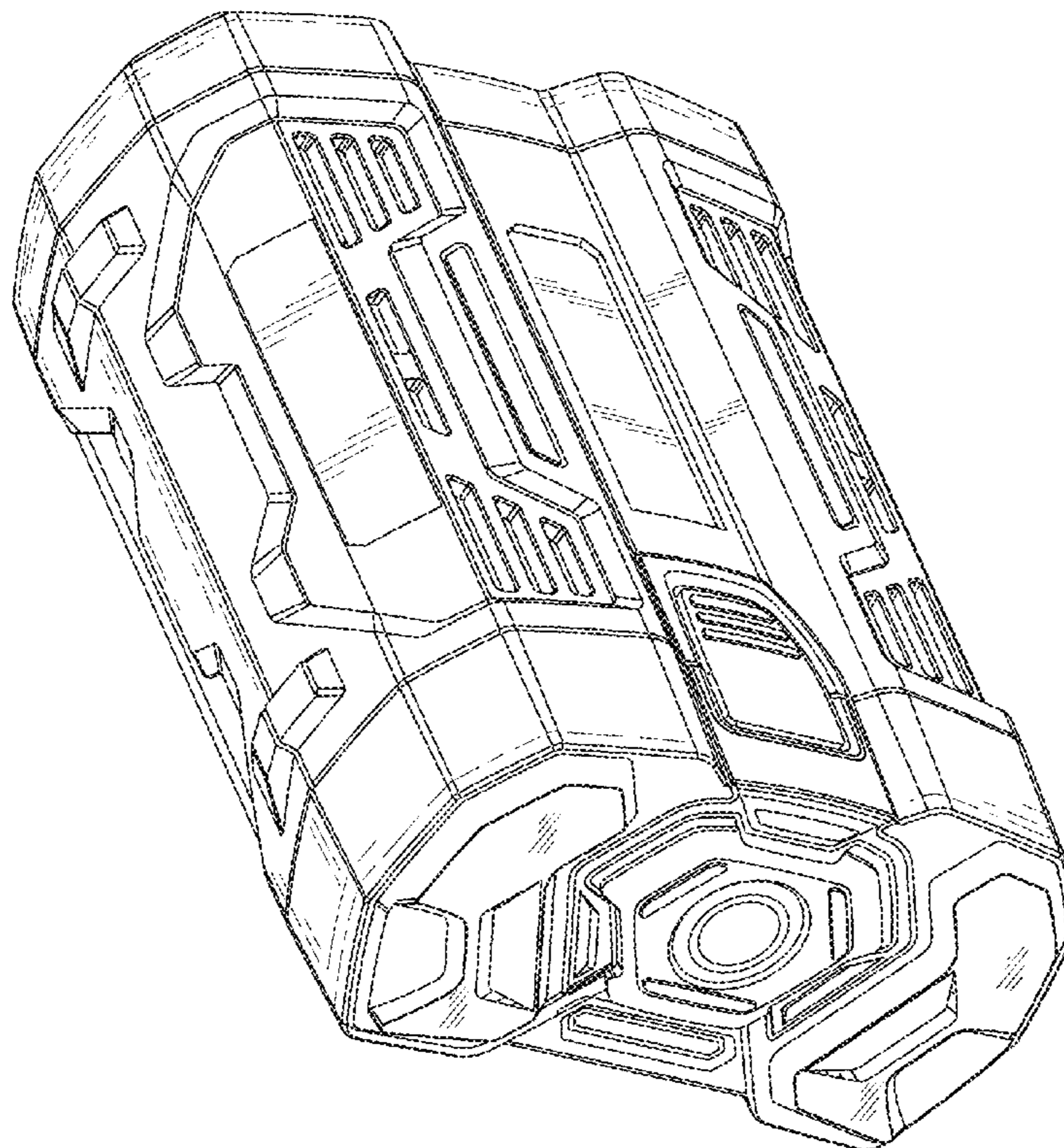

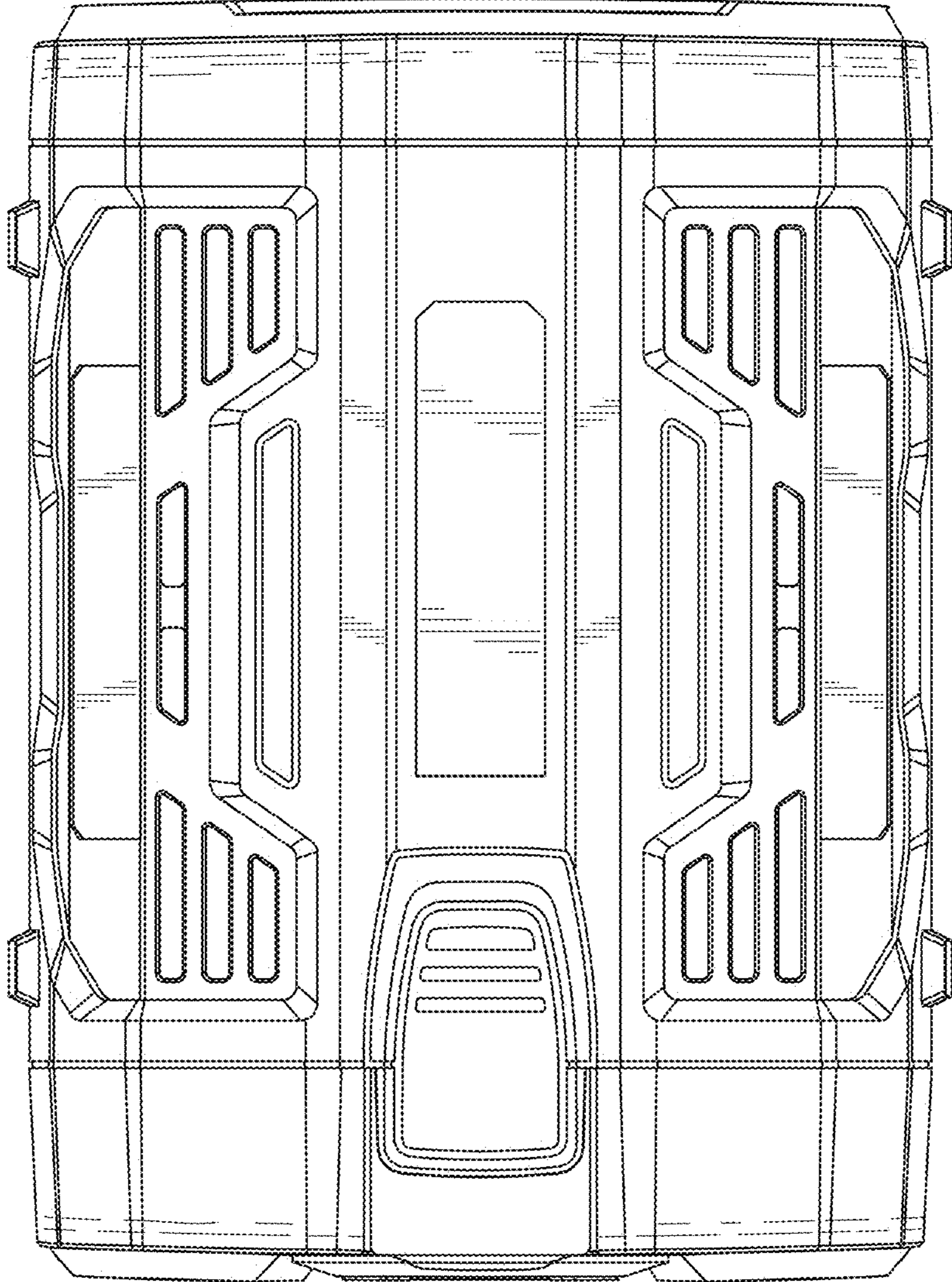

Fig. 1

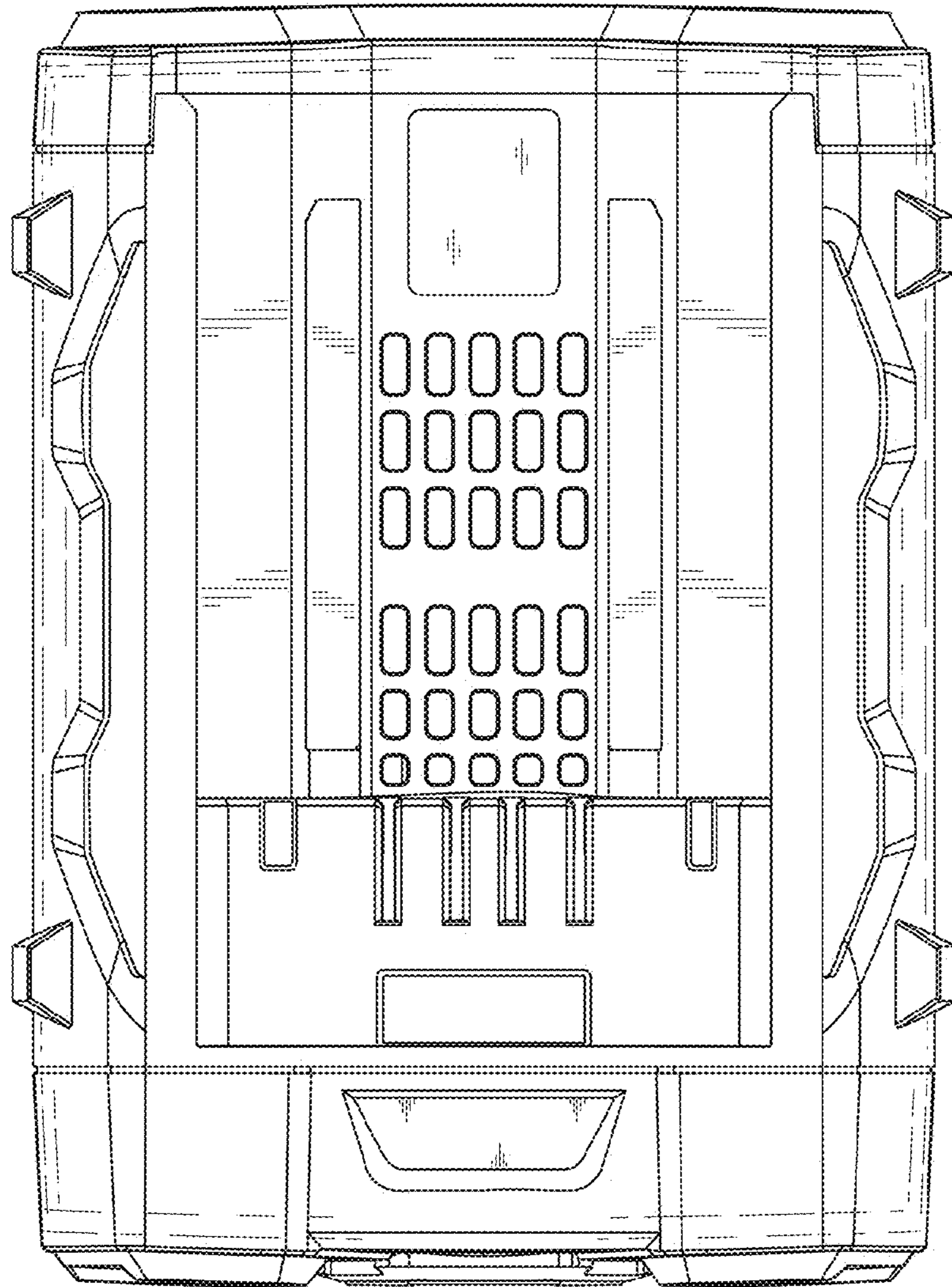

Fig. 2

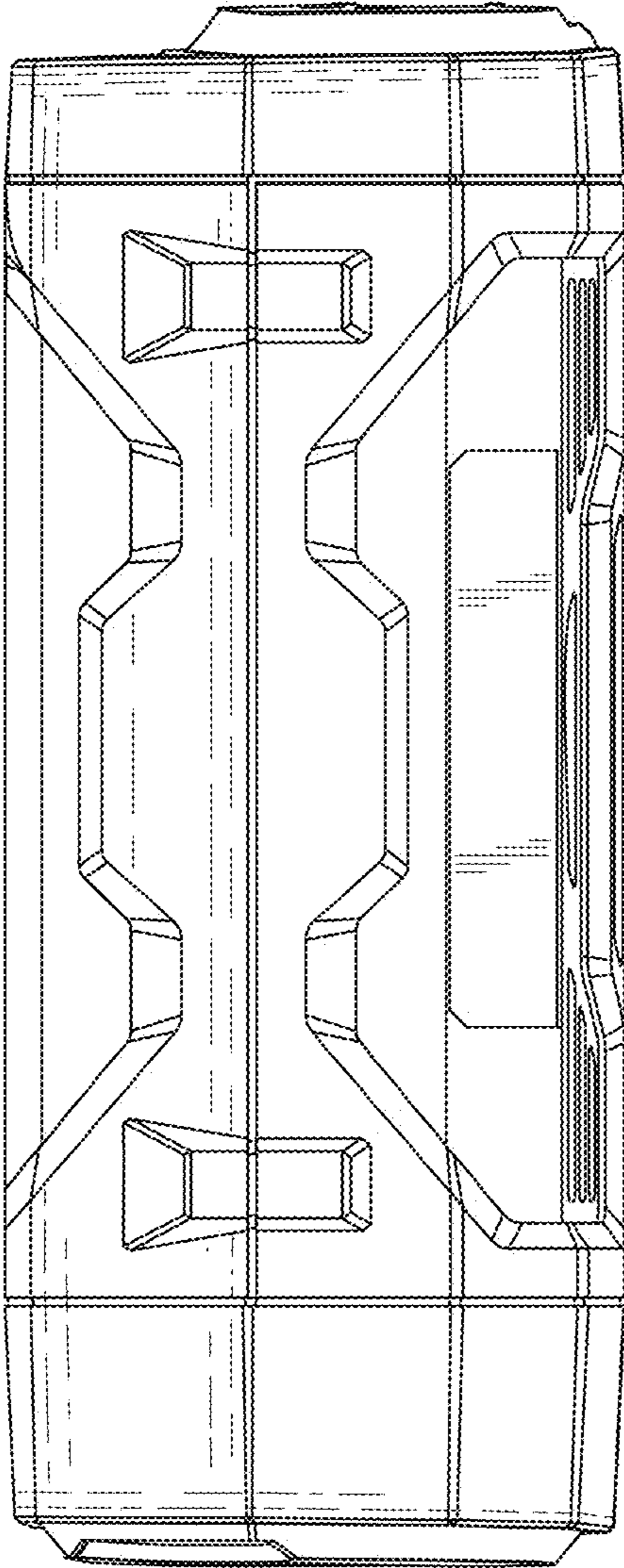

Fig. 3

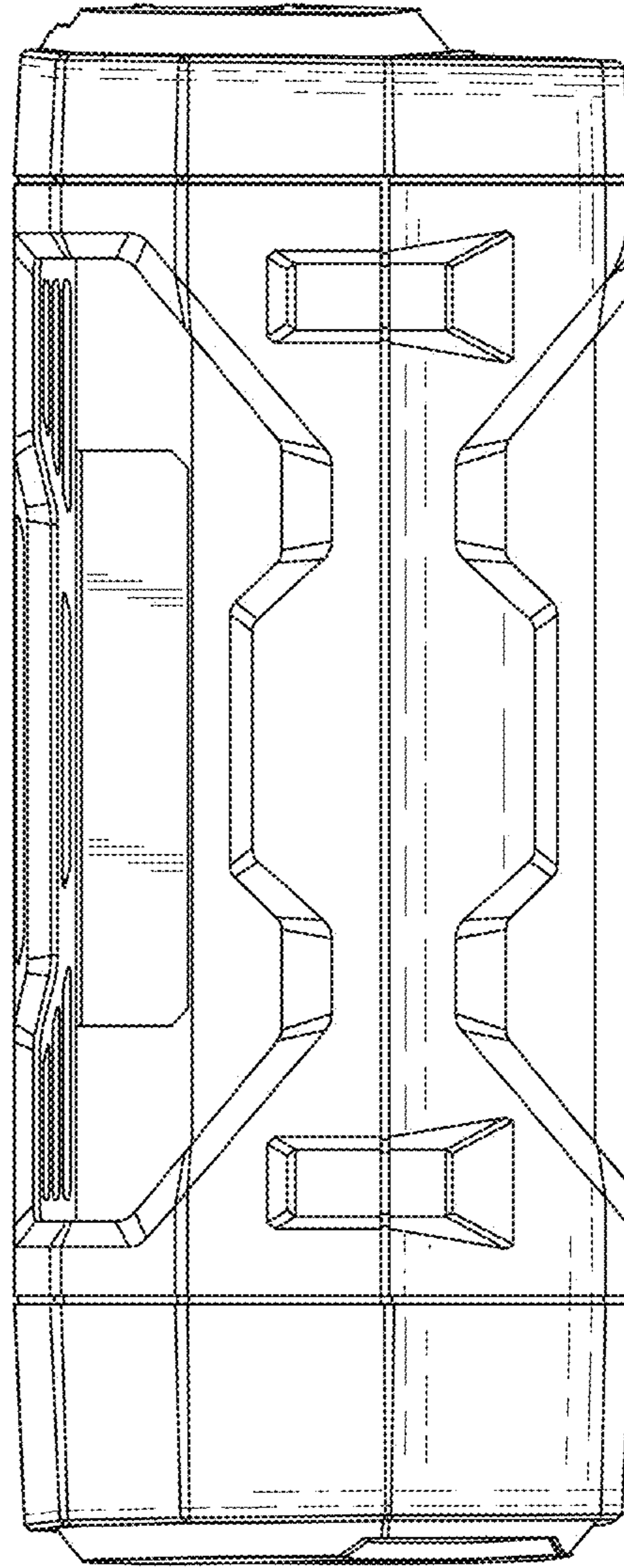

Fig. 4

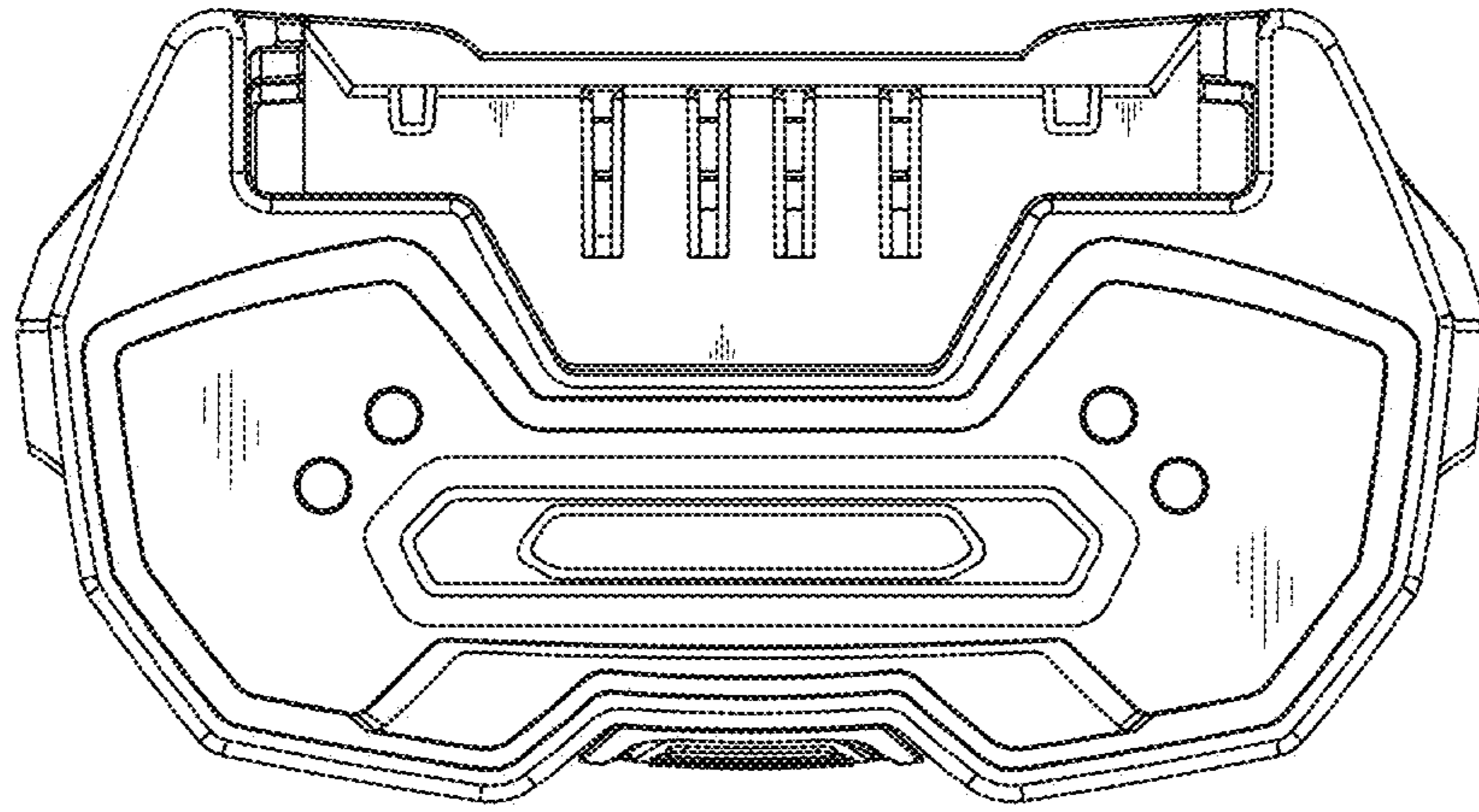

Fig. 5

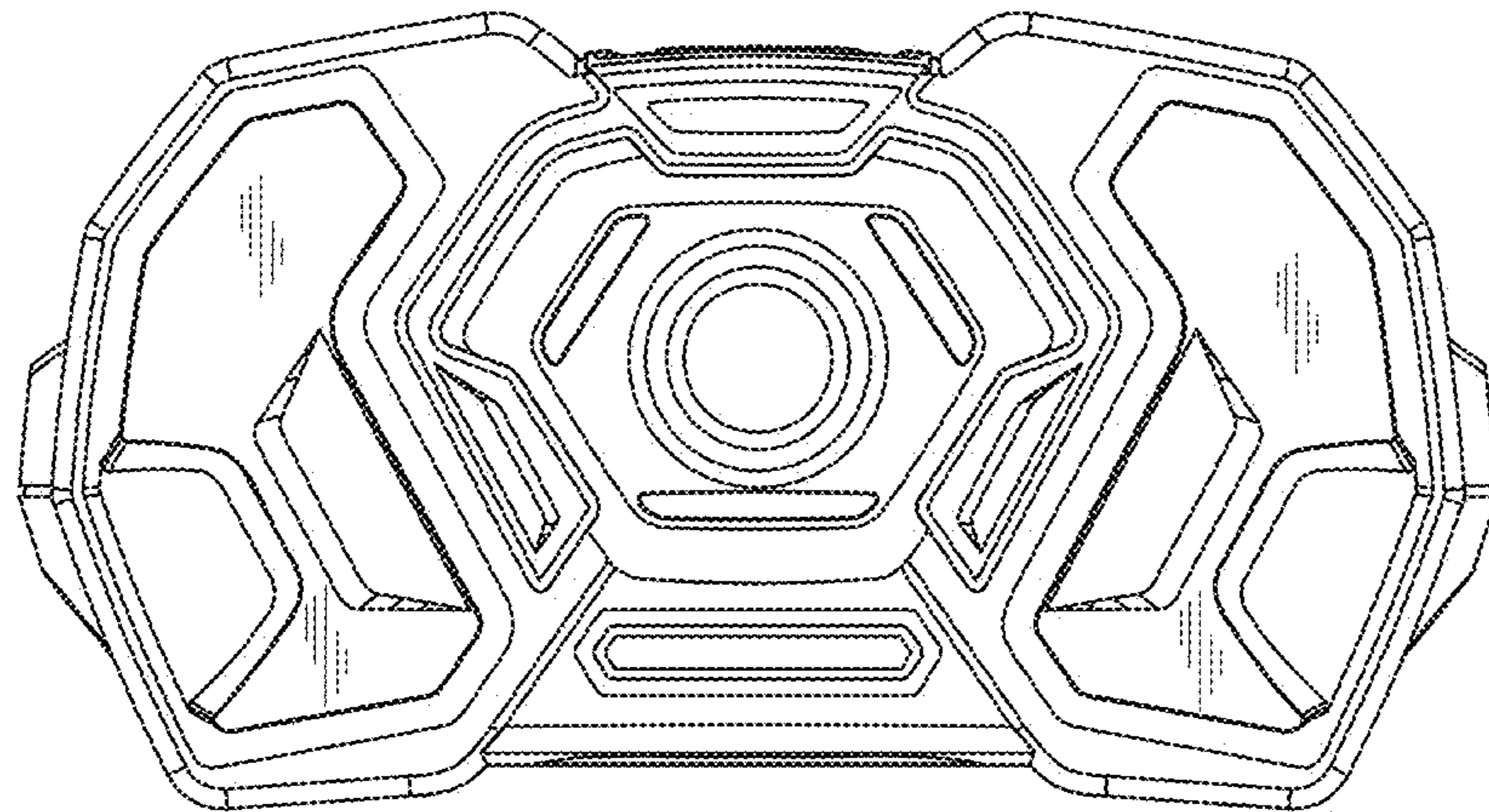

Fig. 6

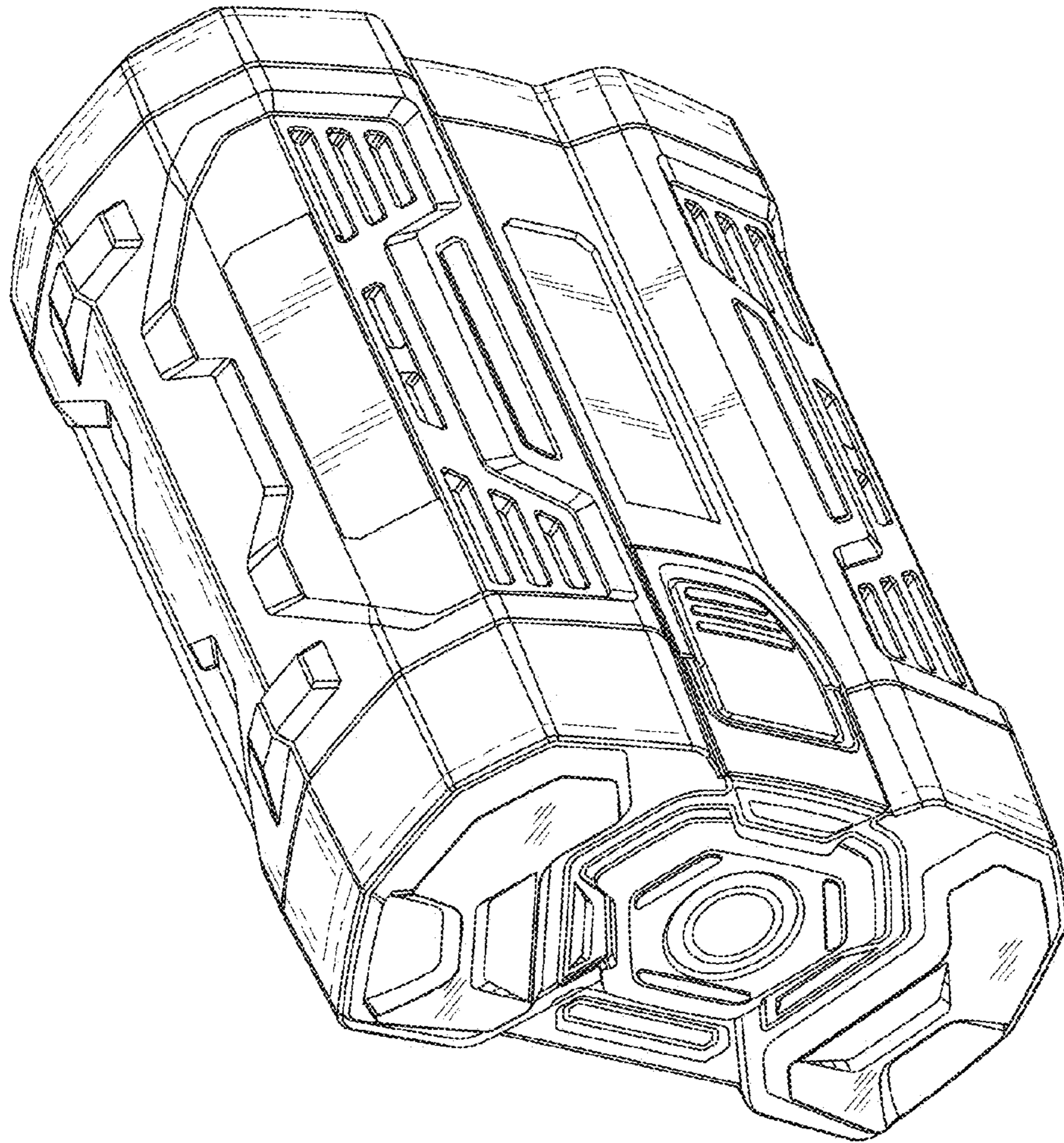

Fig. 7