



US00D712319S

(12) **United States Design Patent**  
**Mays et al.**

(10) **Patent No.:** **US D712,319 S**  
(45) **Date of Patent:** **\*\* Sep. 2, 2014**

(54) **VEHICLE FRONT LOWER GRILLE**  
(71) Applicant: **Ford Motor Company**, Dearborn, MI (US)

D589,853 S \* 4/2009 Saridakis et al. .... D12/163  
D607,785 S \* 1/2010 Walter et al. .... D12/163  
D614,544 S \* 4/2010 Ectors et al. .... D12/163

(Continued)

(72) Inventors: **J C. Mays**, Bloomfield Hills, MI (US);  
**Moray S. Callum**, Ann Arbor, MI (US);  
**Joel Piaskowski**, Brighton (AU);  
**Darrell Behmer**, Novi, MI (US); **Kemal Curic**, West Bloomfield, MI (US)

FOREIGN PATENT DOCUMENTS

JP 2012126270 A \* 7/2012  
JP 2013166502 A \* 8/2013  
WO WO 2007090572 A1 \* 8/2007

OTHER PUBLICATIONS

“14 Mustang. Ready, Set, Gone. Witness the burn.” May 19, 2013 [online], [retrieved on Apr. 11, 2014]. Retrieved from the Internet <URL: [http://www.auto-brochures.com/makes/Ford/Mustang/Ford\\_US%20Mustang\\_2014.pdf](http://www.auto-brochures.com/makes/Ford/Mustang/Ford_US%20Mustang_2014.pdf)>.\*

(Continued)

*Primary Examiner* — Philip S Hyder  
*Assistant Examiner* — Darlington Ly  
(74) *Attorney, Agent, or Firm* — Damian Porcari

(73) Assignee: **Ford Motor Company**, Dearborn, MI (US)

(\*\*) Term: **14 Years**

(21) Appl. No.: **29/476,635**

(22) Filed: **Dec. 16, 2013**

**Related U.S. Application Data**

(63) Continuation of application No. 29/469,983, filed on Oct. 16, 2013.

(51) **LOC (10) Cl.** ..... **12-16**

(52) **U.S. Cl.**  
USPC ..... **D12/163; D12/171**

(58) **Field of Classification Search**  
CPC B60R 19/52; B60R 2019/525; B60K 11/085; B62D 25/084; H01Q 1/32  
USPC ..... D12/86, 90, 91, 92, 163, 169, 196, 171, D12/216; 180/68.1, 68.6; 296/193.11  
See application file for complete search history.

(56) **References Cited**

U.S. PATENT DOCUMENTS

6,328,358 B1 \* 12/2001 Berweiler ..... 293/115  
D492,624 S \* 7/2004 Elwell et al. .... D12/163  
7,152,915 B2 \* 12/2006 Diehl et al. .... 296/193.1  
D584,197 S \* 1/2009 Song et al. .... D12/163

(57) **CLAIM**

The ornamental design for a vehicle front lower grille, as shown and described.

**DESCRIPTION**

FIG. 1 is a top plan view of a vehicle front lower grille;  
FIG. 2 is a bottom plan view thereof;  
FIG. 3 is a front elevational view thereof  
FIG. 4 is a left side elevational view thereof;  
FIG. 5 is a right side elevational view thereof;  
FIG. 6 is a bottom, front, and left-side perspective view thereof; and,  
FIG. 7 is a bottom, front, and right-side perspective view thereof.

**1 Claim, 7 Drawing Sheets**

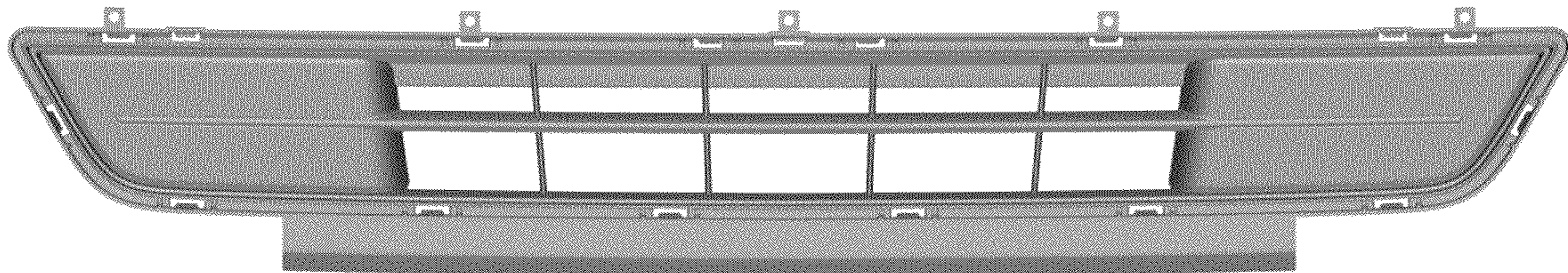

(56)

**References Cited**

U.S. PATENT DOCUMENTS

D626,897 S \* 11/2010 Ectors et al. .... D12/163  
D628,522 S \* 12/2010 Fesler et al. .... D12/163  
D633,832 S \* 3/2011 Matei et al. .... D12/163  
D679,225 S \* 4/2013 Gifford ..... D12/163  
D680,921 S \* 4/2013 Jara ..... D12/163  
2013/0119709 A1 \* 5/2013 Guenther et al. .... 296/193.1

OTHER PUBLICATIONS

“2001-04 Ford F-150 SVT Lightning Front Lower Grill.” Late Model Restoration. Nov. 9, 2010 [online], [retrieved on Apr. 11, 2014]. Retrieved from the Internet <URL: <http://www.latemodelrestoration.com/item/LTP-8200C/2001-04-Ford-Lightning-Front-Lower-Grille>>.\*

\* cited by examiner

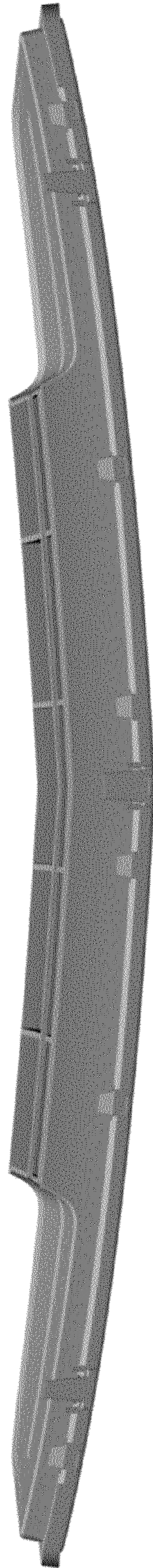

*Figure 1*

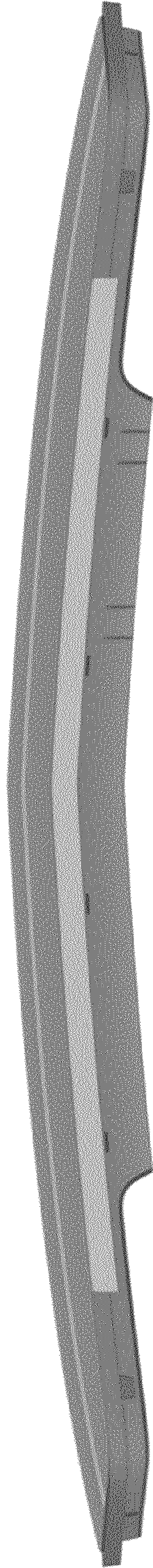

Figure 2

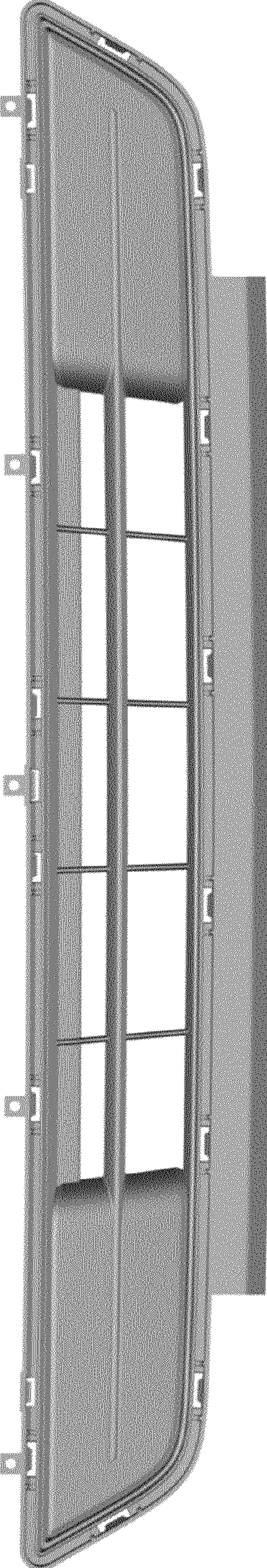
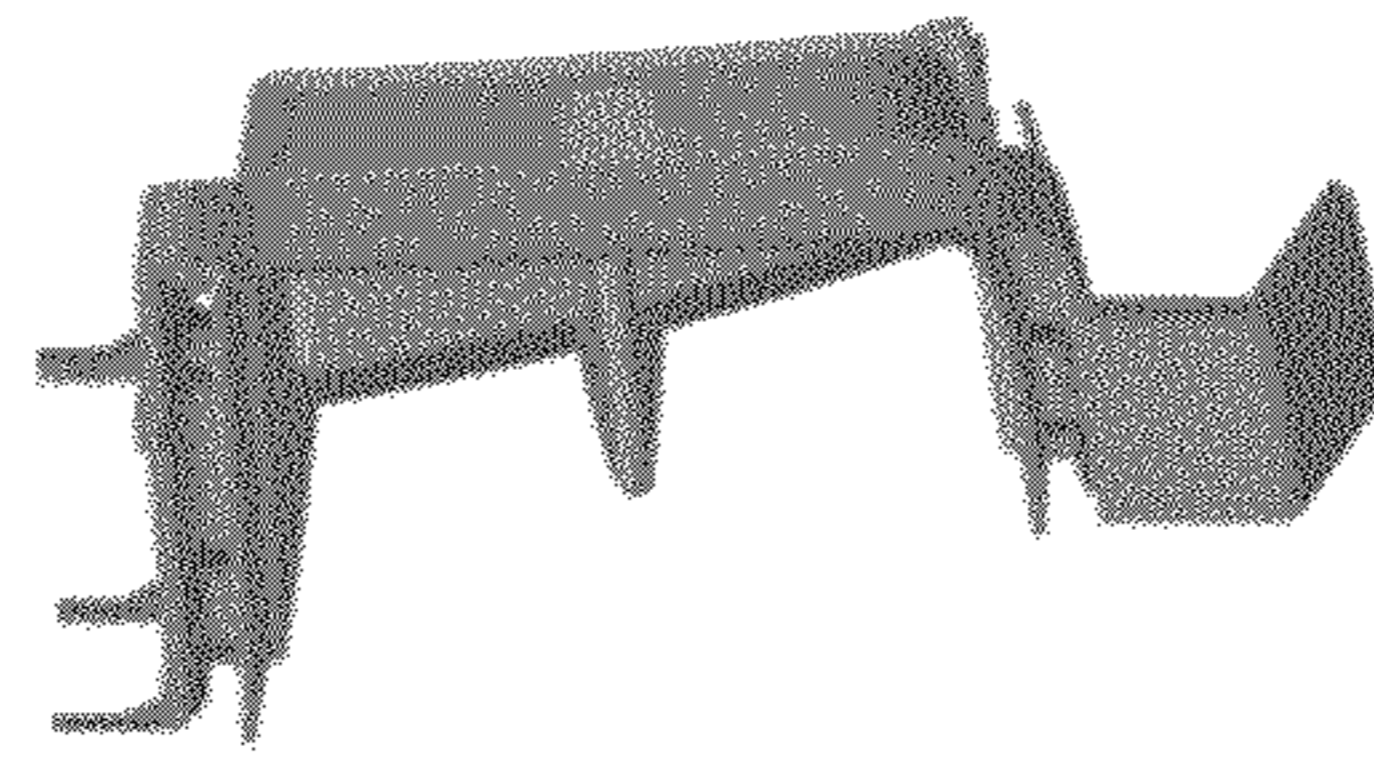

Figure 3



*Figure 4*

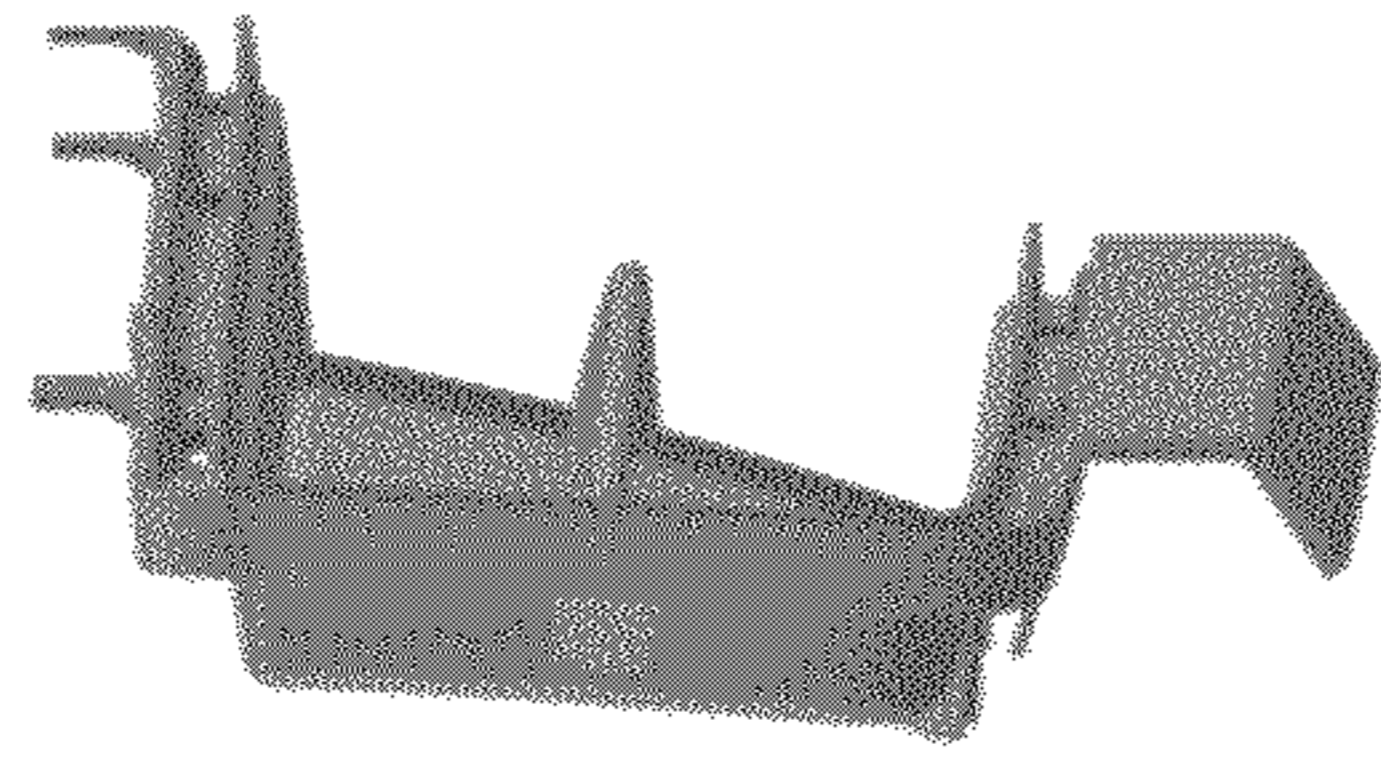

Figure 5

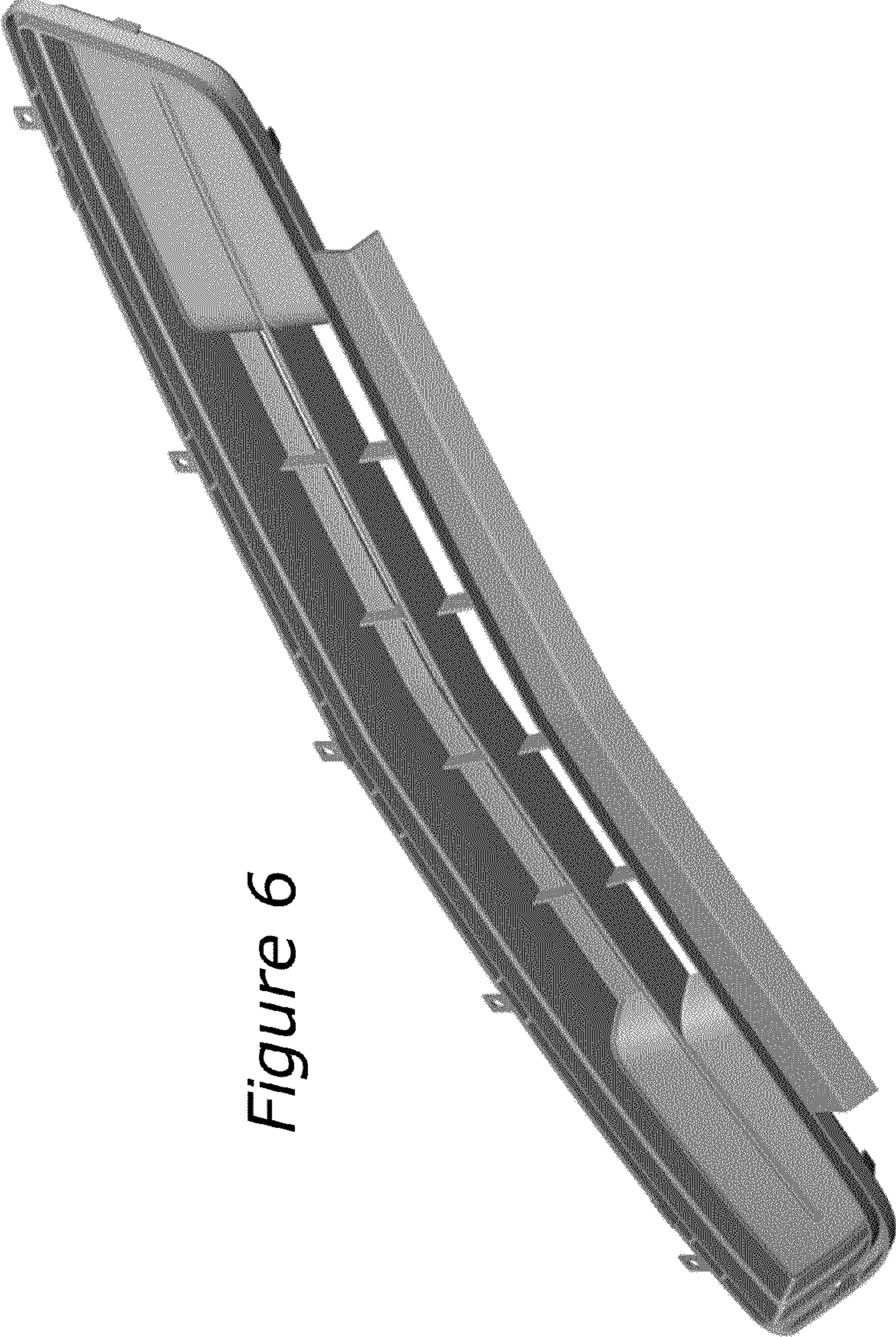

Figure 6



Figure 7

