



US00D712287S

(12) **United States Design Patent**
Michaelian

(10) **Patent No.:** **US D712,287 S**

(45) **Date of Patent:** **** Sep. 2, 2014**

(54) **FOOT MEASURING DEVICE**

(71) Applicant: **Robert Michaelian**, Newport Beach, CA (US)

(72) Inventor: **Robert Michaelian**, Newport Beach, CA (US)

(**) Term: **14 Years**

(21) Appl. No.: **29/451,613**

(22) Filed: **Apr. 4, 2013**

(51) **LOC (10) Cl.** **10-04**

(52) **U.S. Cl.**
USPC **D10/70**

(58) **Field of Classification Search**

CPC A43D 1/025; A43D 1/02; A61B 5/1074;
A61B 5/4528; A61B 5/1036
USPC D10/70, 71; 33/3 R, 3 A, 3 B, 3 C, 511,
33/512, 515; 600/592

See application file for complete search history.

(56) **References Cited**

U.S. PATENT DOCUMENTS

D419,080 S *	1/2000	Panek	D10/70
D469,703 S *	2/2003	Stahl	D10/70
D519,016 S *	4/2006	Nudo	D8/71
7,421,789 B1 *	9/2008	Sullivan	33/3 R
7,516,555 B2 *	4/2009	Sullivan	33/3 R

* cited by examiner

Primary Examiner — Antoine D Davis

(74) *Attorney, Agent, or Firm* — Knobbe, Martens, Olson & Bear, LLP

(57) **CLAIM**

The ornamental designs for a foot measuring device, as shown and described.

DESCRIPTION

FIG. 1 is a front perspective view of a foot measuring device; FIG. 2 is a back perspective view thereof; FIG. 3 is a front view thereof with the slider element in a first position; FIG. 4 is a front view thereof with the slider element in a second position; FIG. 5 is a back view thereof; FIG. 6 is a left side view thereof; FIG. 7 is a right side view thereof; FIG. 8 is a top end view thereof; FIG. 9 is a bottom end view thereof; FIG. 10 is a front perspective view of a foot measuring device; FIG. 11 is a back perspective view thereof; FIG. 12 is a front view thereof with the slider element in a first position; FIG. 13 is a front view thereof with the slider element in a second position; FIG. 14 is a back view thereof; FIG. 15 is a left side view thereof; FIG. 16 is a right side view thereof; FIG. 17 is a top end view thereof; and, FIG. 18 is a bottom end view thereof.

All features illustrated in phantom line are expressly disclaimed and form no part of the claimed design.

1 Claim, 14 Drawing Sheets

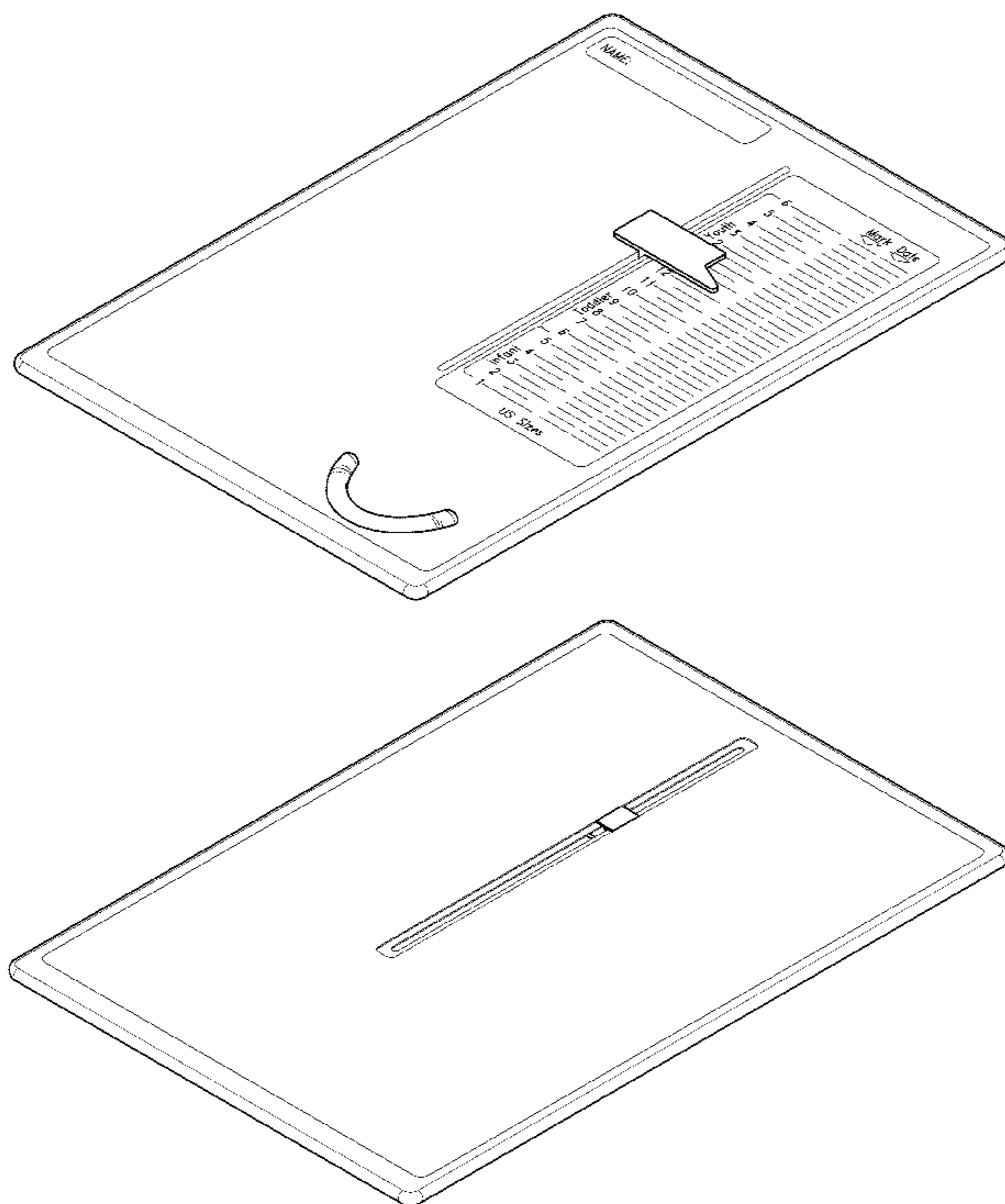

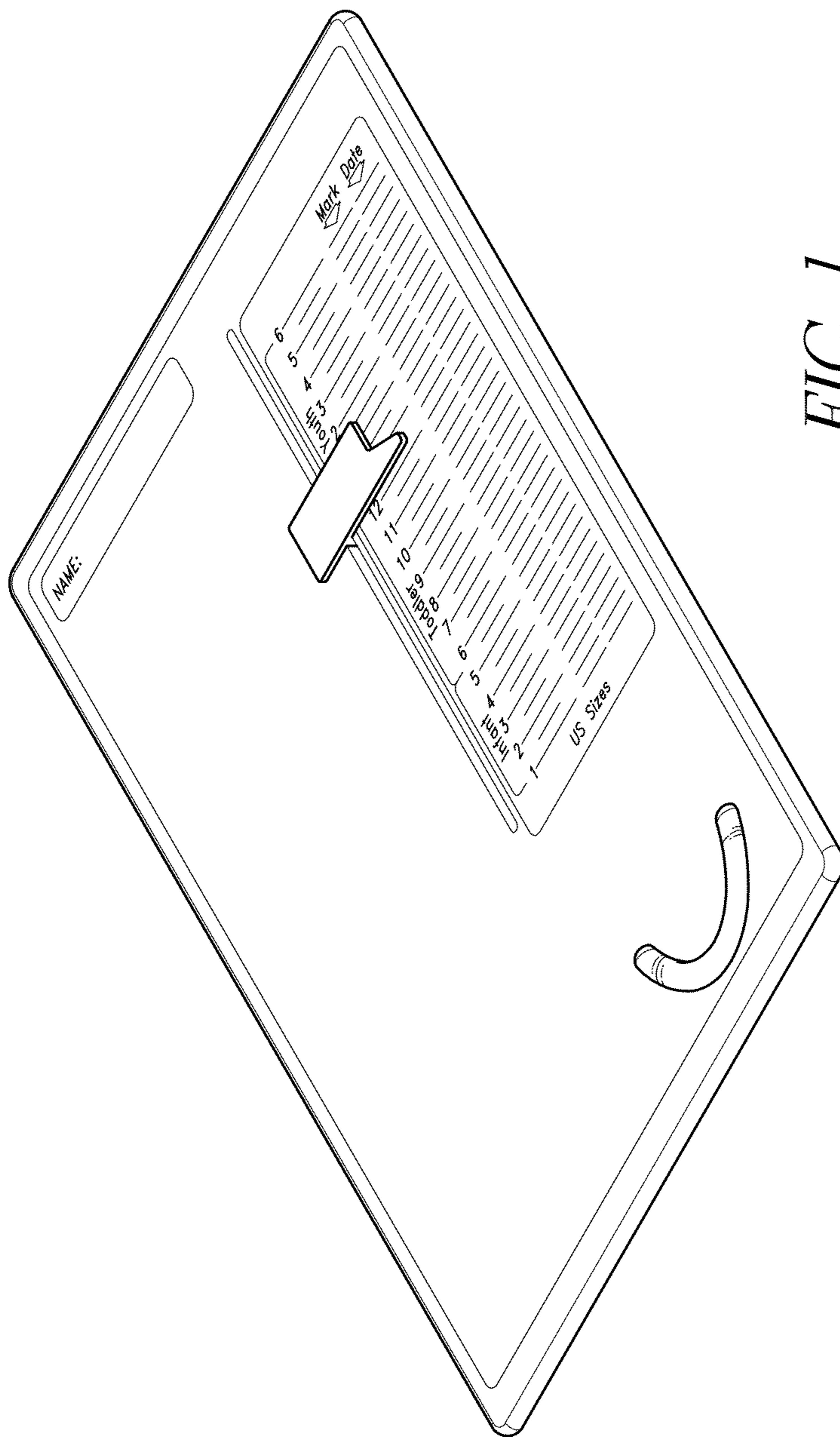

FIG. 1

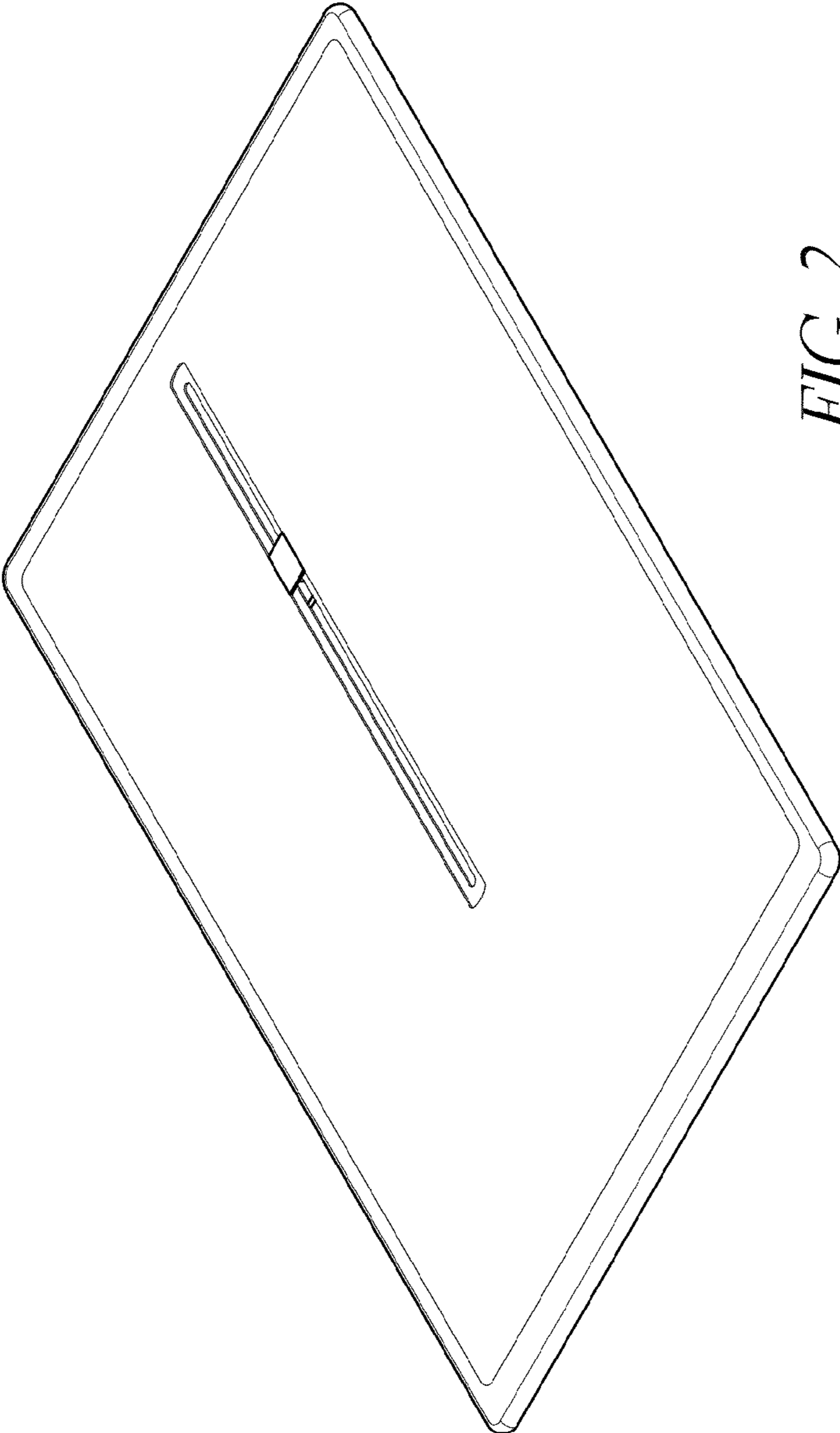

FIG. 2

NAME: _____

	Mark	Date
6	_____	_____
5	_____	_____
4	_____	_____
Youth	3	_____
	2	_____
	1	_____
Toddler	12	_____
	11	_____
	10	_____
	9	_____
	8	_____
	7	_____
Infant	6	_____
	5	_____
	4	_____
	3	_____
	2	_____
1	_____	

US Sizes

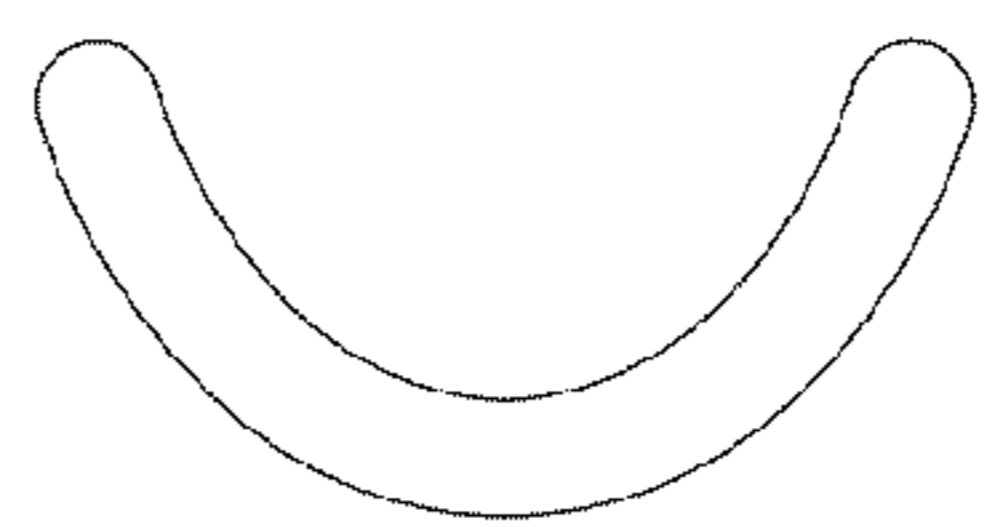
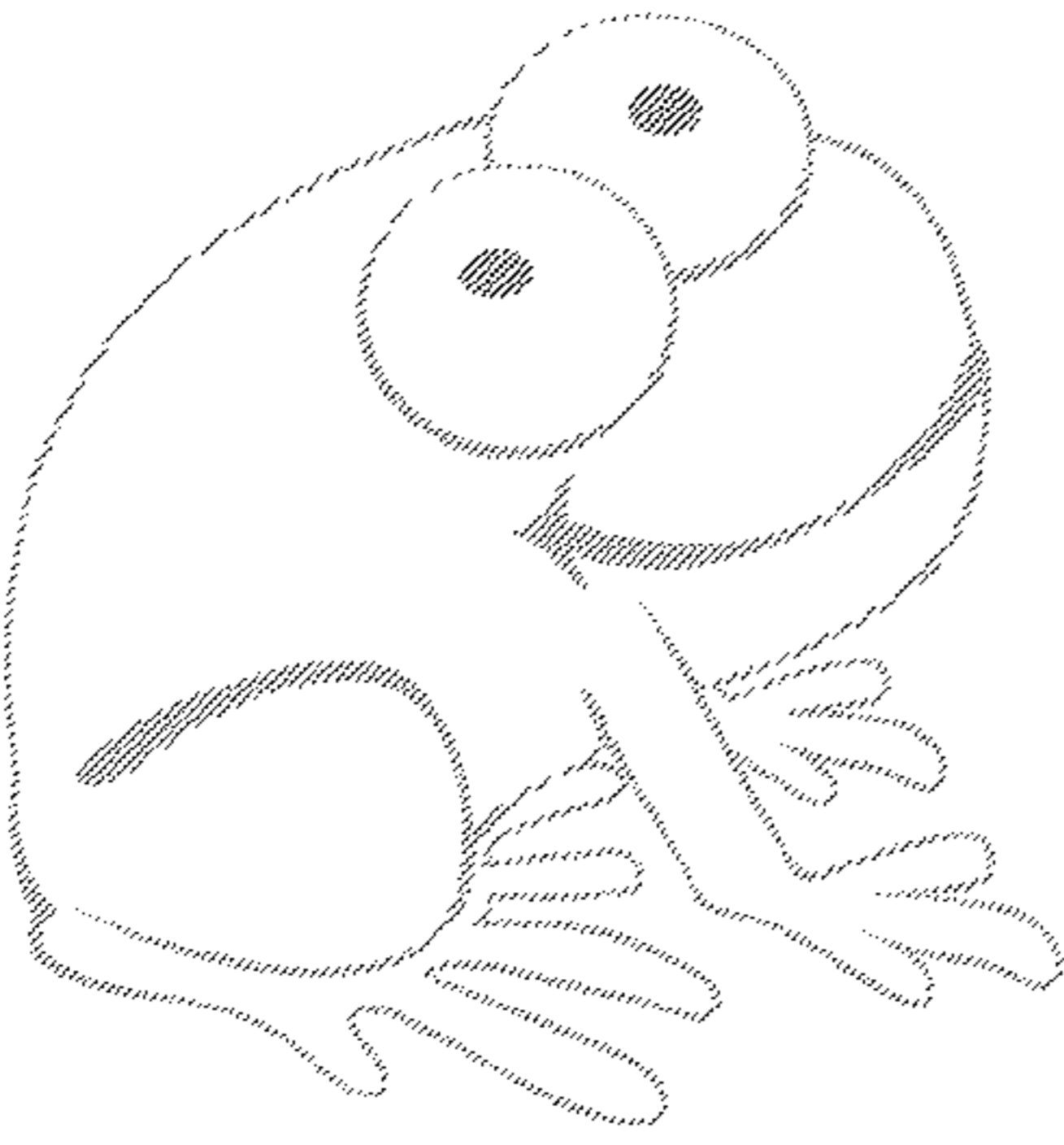

FIG. 3

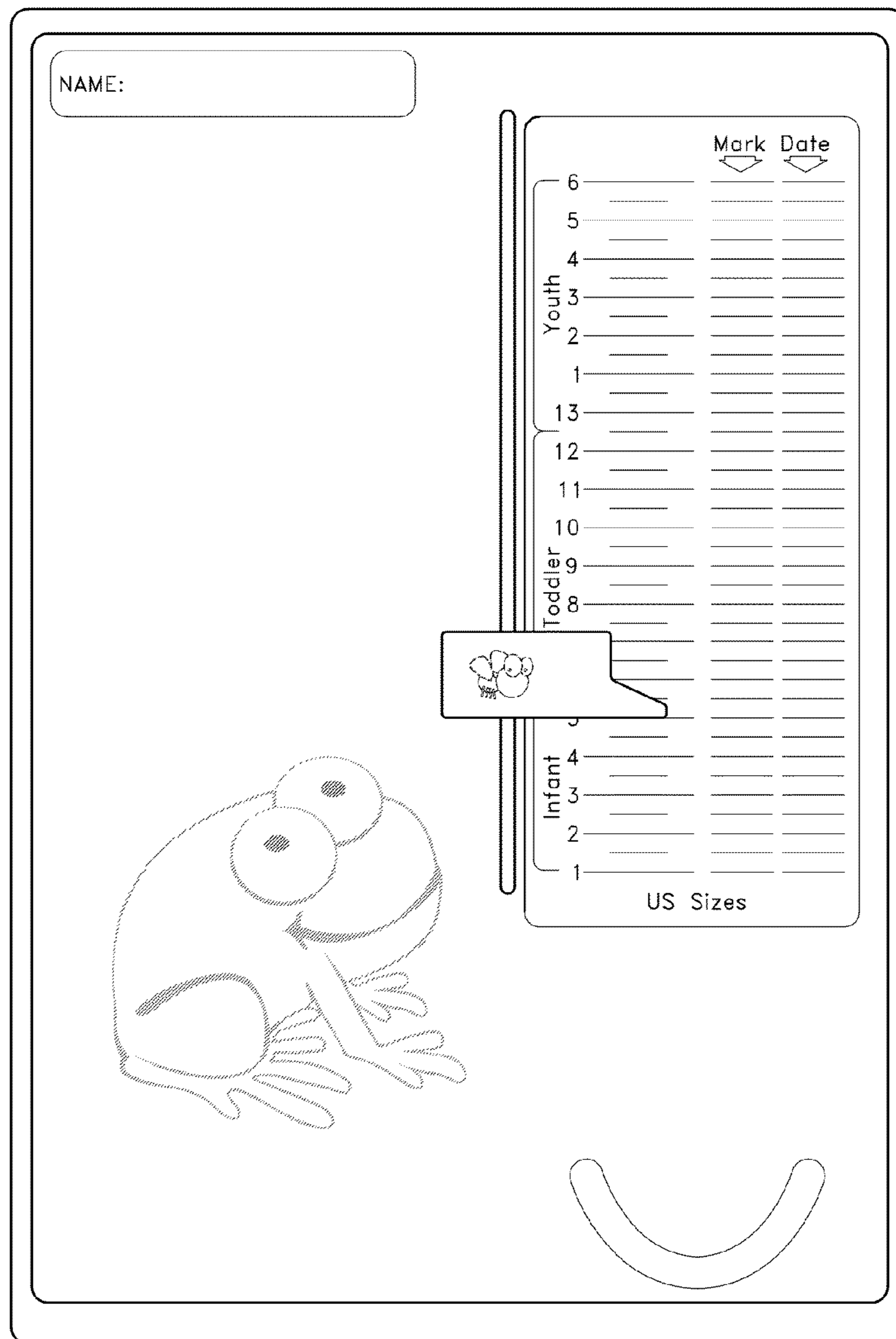

FIG. 4

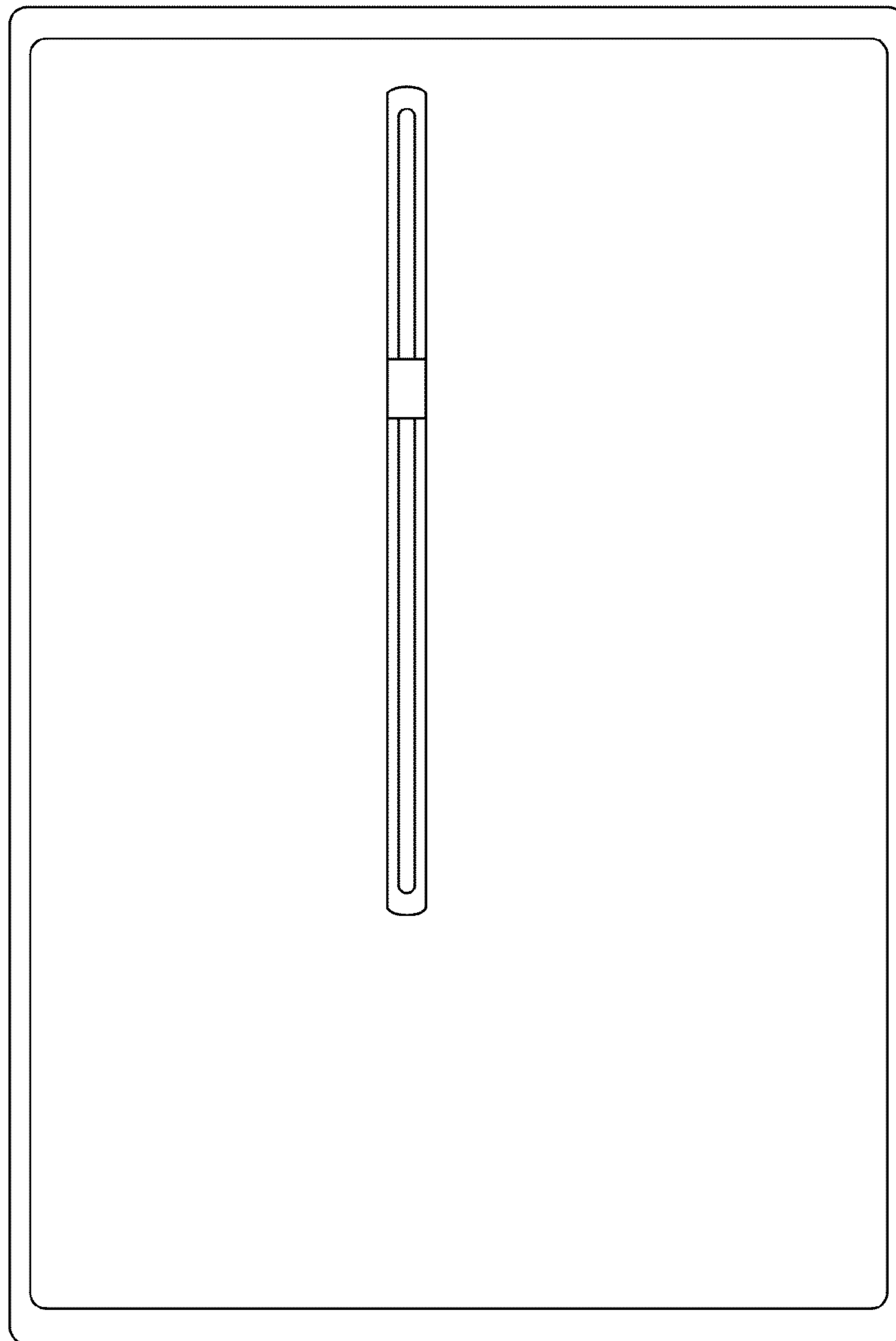

FIG. 5



FIG. 6

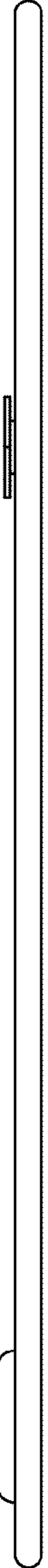

FIG. 7

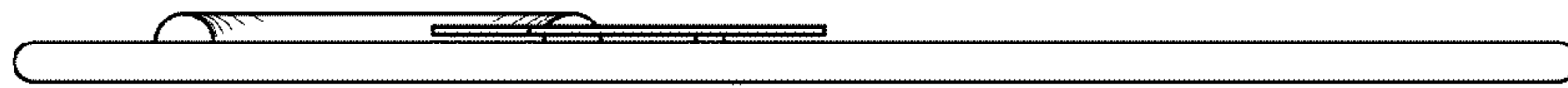

FIG. 8



FIG. 9

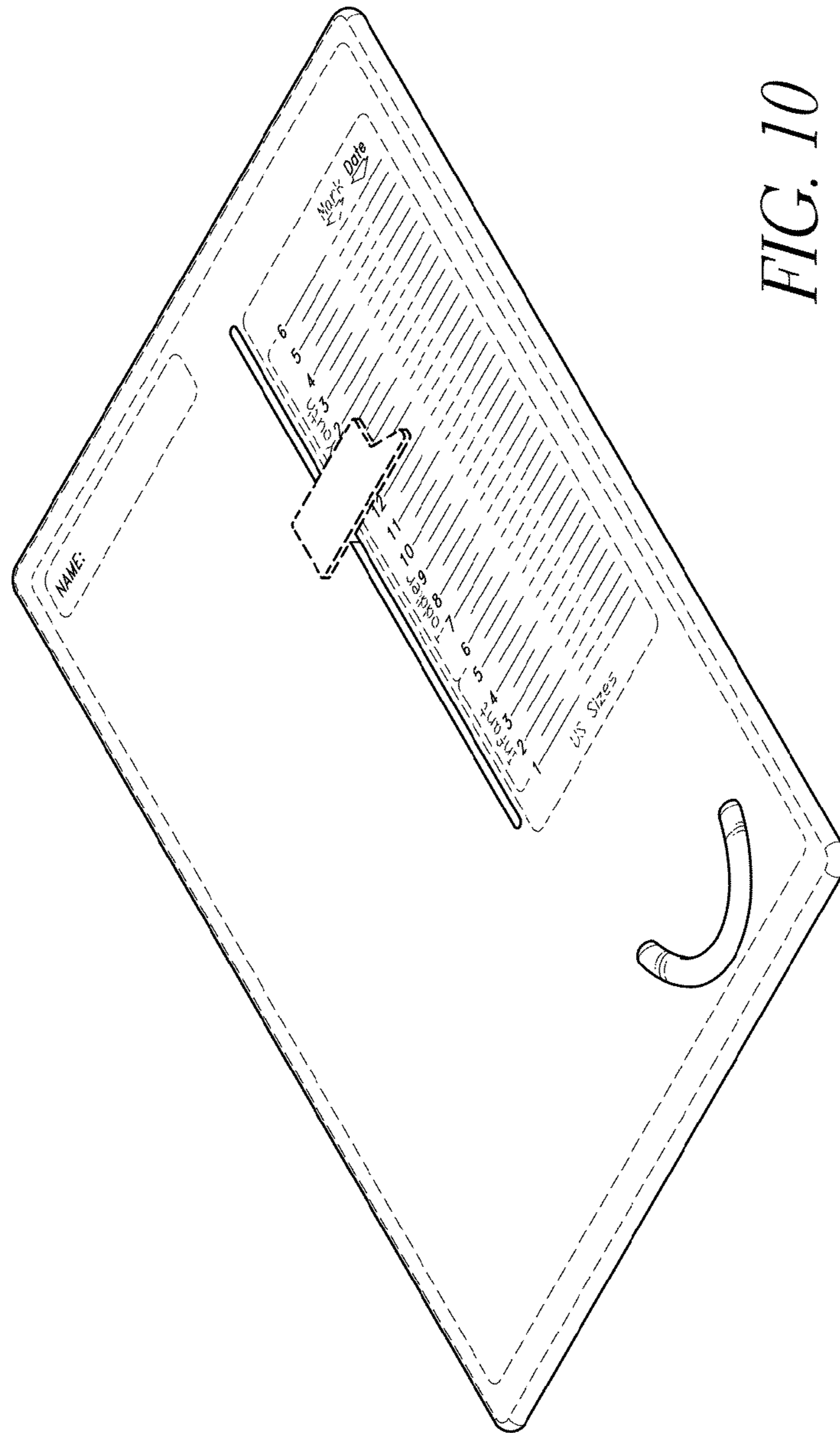

FIG. 10

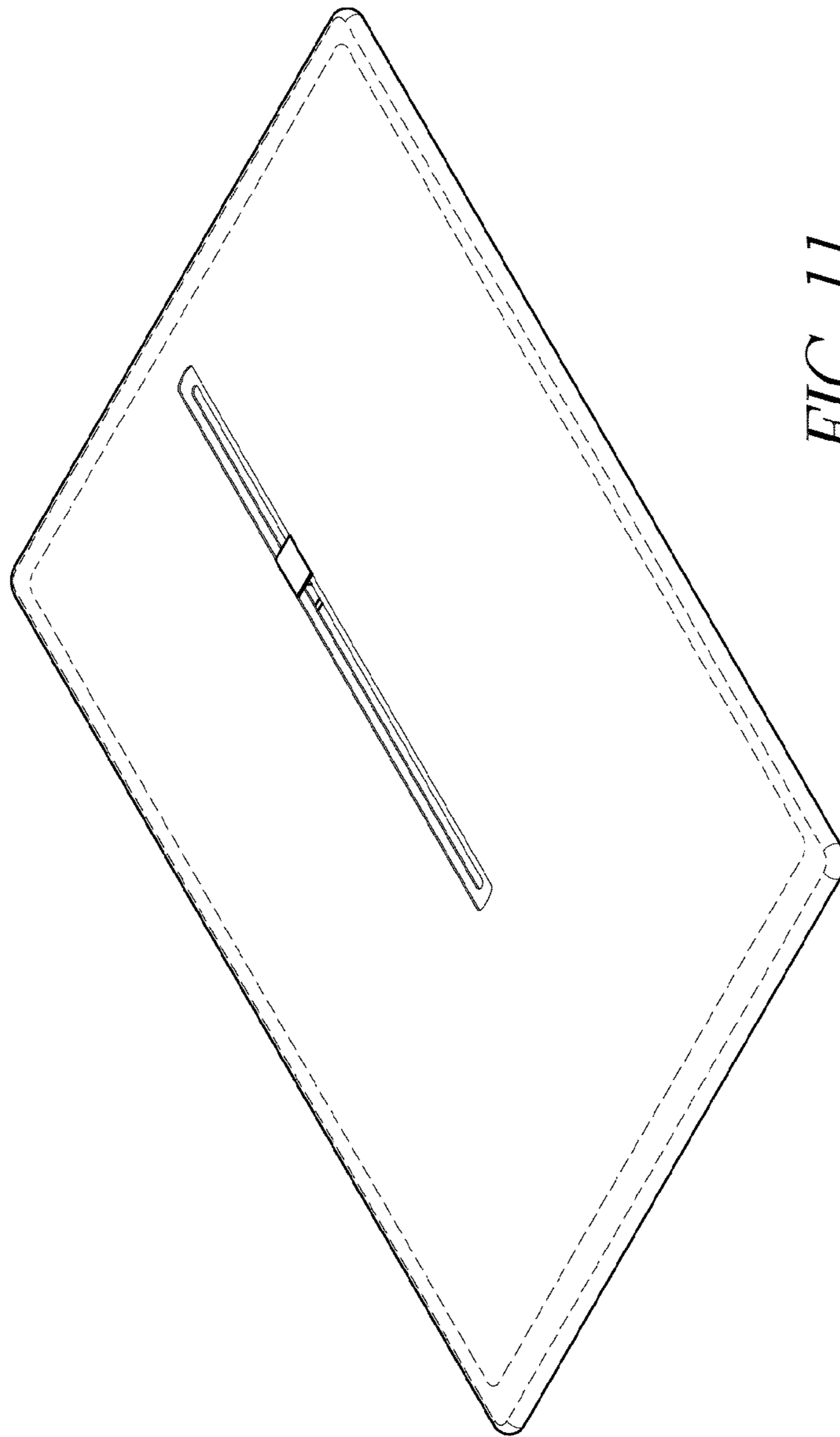

FIG. 11

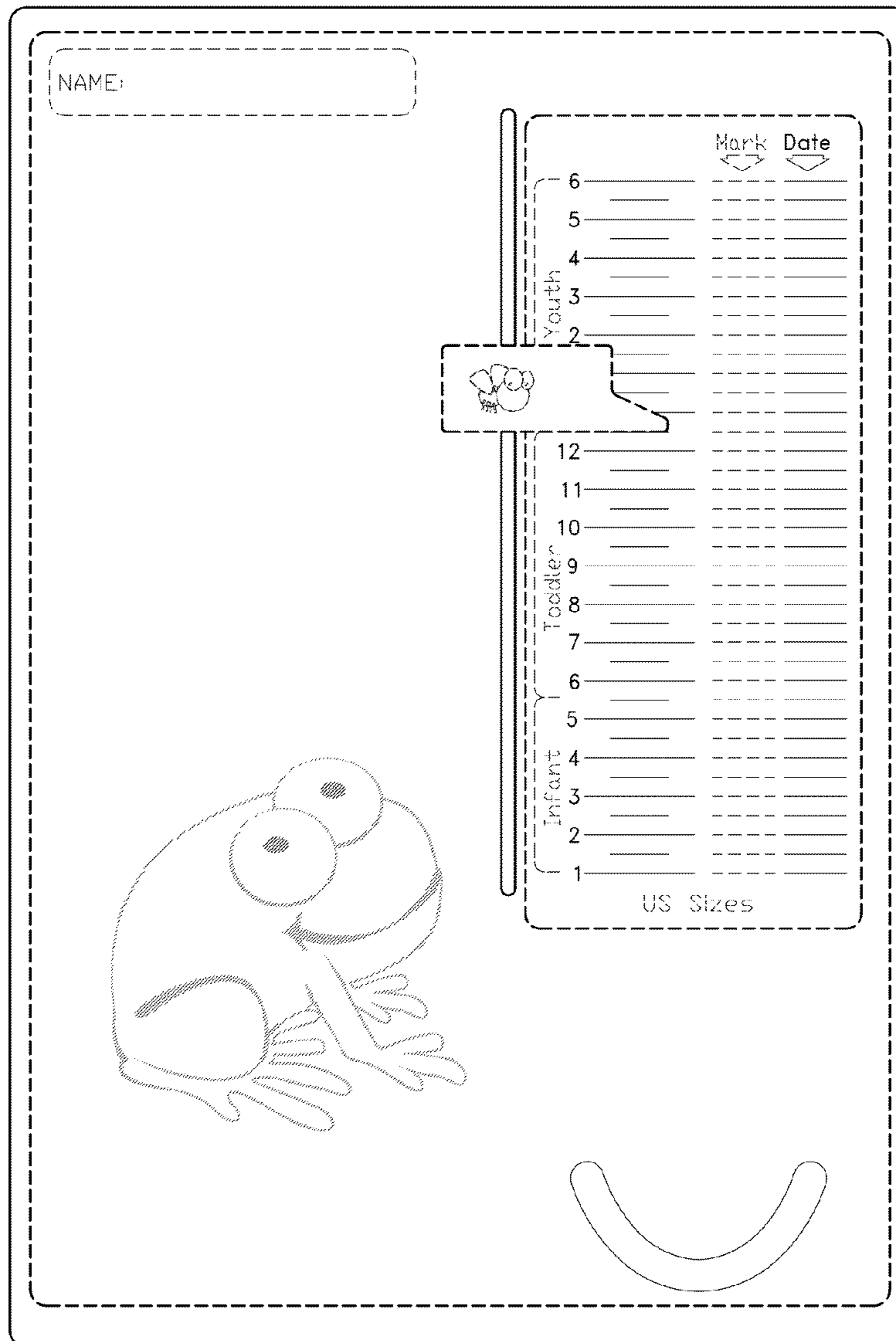

FIG. 12

NAME: _____

	Mark	Date
6	_____	_____
5	_____	_____
4	_____	_____
Youth	3	_____
	2	_____
	1	_____
Toddler	13	_____
	12	_____
	11	_____
	10	_____
	9	_____
8	_____	
Infant	5	_____
	4	_____
	3	_____
	2	_____
1	_____	

US Sizes

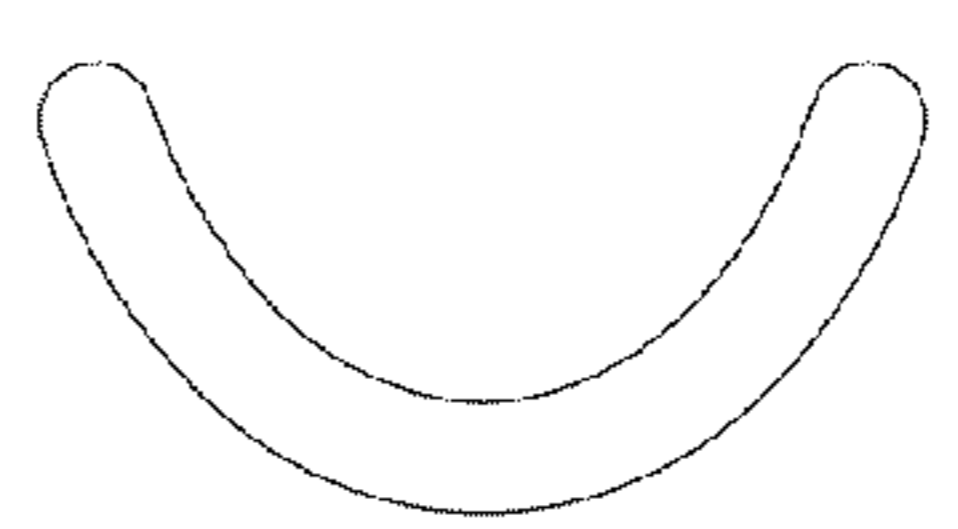
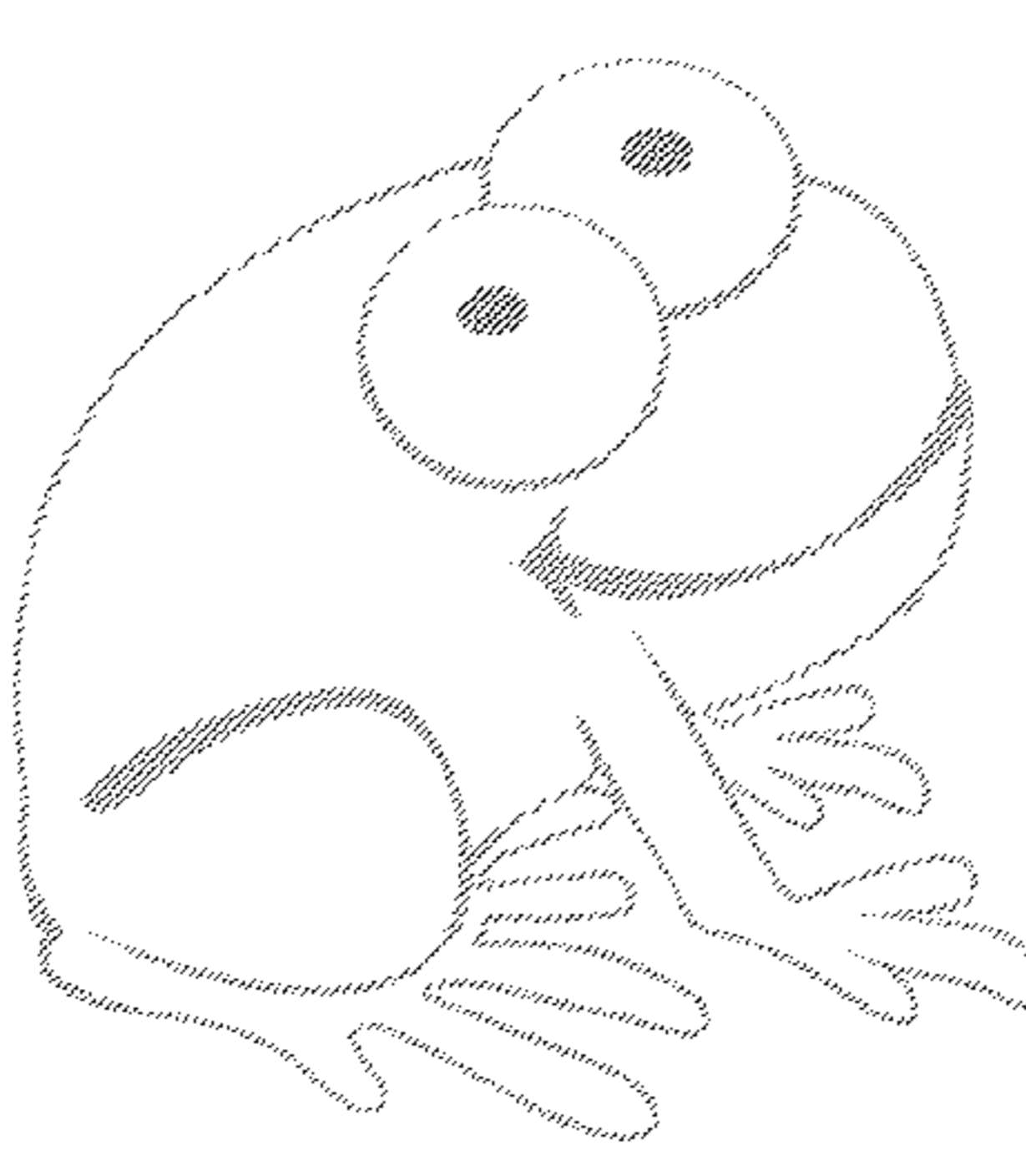

FIG. 13

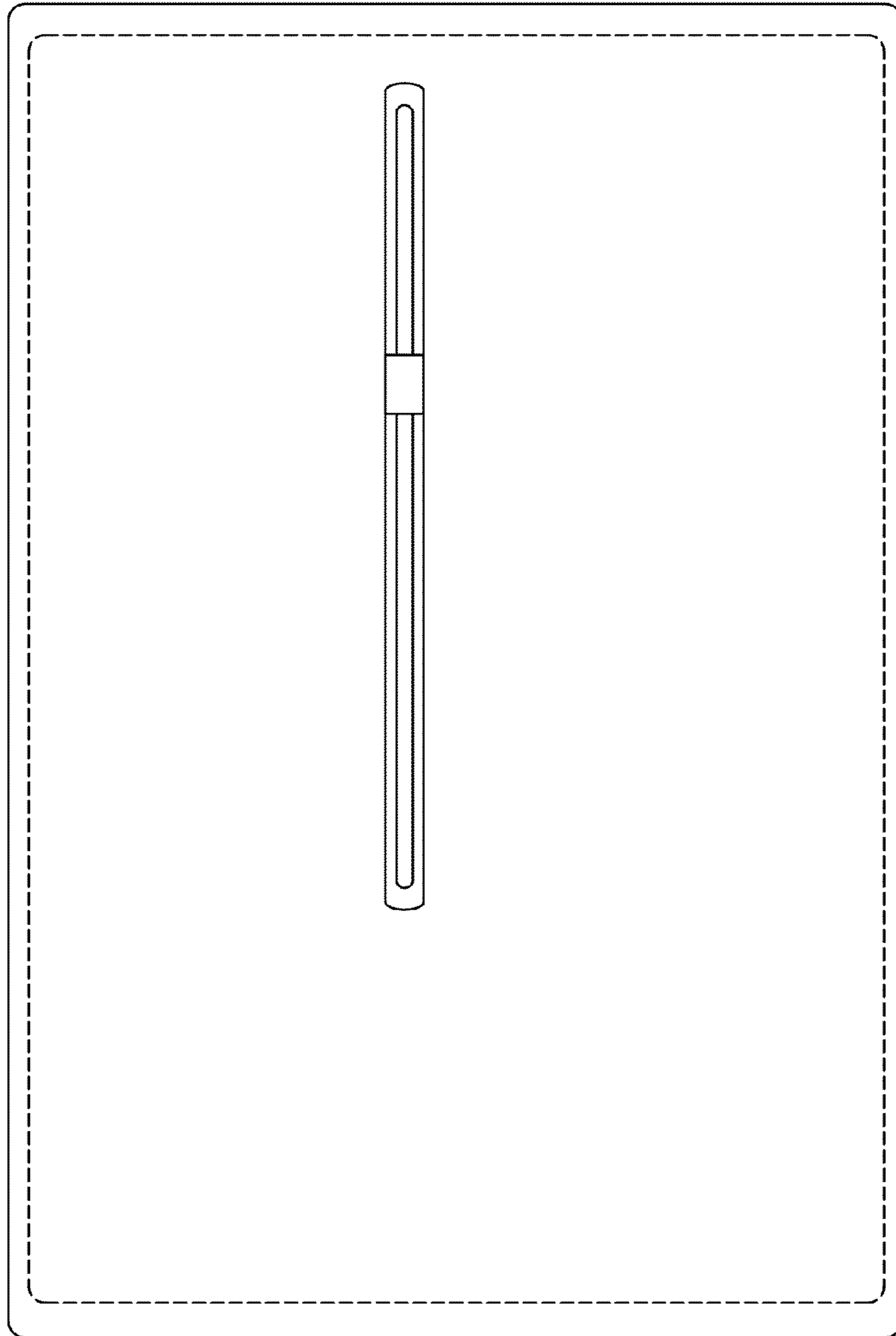

FIG. 14



FIG. 15



FIG. 16

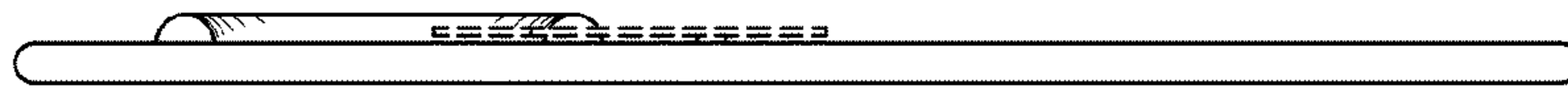

FIG. 17



FIG. 18