

US00D712267S

(12) **United States Design Patent**  
**Handy**

(10) **Patent No.:** **US D712,267 S**

(45) **Date of Patent:** **\*\* Sep. 2, 2014**

(54) **BOTTLE**

(71) Applicant: **Method Products, PBC**, San Francisco, CA (US)

(72) Inventor: **Francis J. Handy**, San Rafael, CA (US)

(73) Assignee: **Method Products, PBC**, San Francisco, CA (US)

(\*\*) Term: **14 Years**

(21) Appl. No.: **29/462,831**

(22) Filed: **Aug. 8, 2013**

(51) **LOC (10) Cl.** ..... **09-01**

(52) **U.S. Cl.**  
USPC ..... **D9/500**

(58) **Field of Classification Search**  
CPC ..... B65D 1/00; B65D 1/02; B65D 1/0223;  
B65D 23/00  
USPC ..... D9/500-505, 516, 530, 537-540,  
D9/544-545, 549, 558, 682, 685-686,  
D9/688-691; D6/542; 215/379, 381-382;  
220/660, 669, 675; 206/77.1

See application file for complete search history.

(56) **References Cited**

**U.S. PATENT DOCUMENTS**

1,164,848 A	12/1915	Neukirchen
1,309,948 A	7/1919	Kositchek
D59,583 S	11/1921	Green
D93,524 S	10/1934	Seidner
2,059,748 A	11/1936	Rose
D117,266 S	10/1939	Gerhart
D120,672 S	5/1940	Harris
D136,501 S	10/1943	Habif
D139,381 S	11/1944	Harris
2,576,416 A	11/1951	Randlett
D165,734 S	1/1952	Barton
D189,374 S	11/1960	Harris
2,990,076 A	6/1961	Stull

3,002,722 A	10/1961	Cote	
3,130,877 A	4/1964	Miller	
3,198,400 A	8/1965	Roehrich	
D203,008 S	11/1965	Ota	
D210,351 S *	3/1968	Fuerst	D9/500
D210,571 S *	3/1968	Vanderhyde	D9/538
D216,539 S	2/1970	Trotti et al.	

(Continued)

**FOREIGN PATENT DOCUMENTS**

EM 001042048-0001 11/2008

**OTHER PUBLICATIONS**

“Foaming Hand Eucalyptus Mint”, <<http://www.methodhome.com/all-products/green-herbaceous/eucalyptus-mint/563.aspx>>, downloaded Apr. 29, 2010.

*Primary Examiner* — Ian Simmons

*Assistant Examiner* — Dana L Meyrow

(74) *Attorney, Agent, or Firm* — Sterne, Kessler, Goldstein & Fox P.L.L.C.

(57) **CLAIM**

The ornamental design for a bottle, as shown and described.

**DESCRIPTION**

FIG. 1 is a top, front perspective view of a bottle showing my new design;  
FIG. 2 is a top, rear perspective view thereof;  
FIG. 3 is a front view thereof;  
FIG. 4 is a right side view thereof, the left side being a mirror image thereof;  
FIG. 5 is a rear view thereof;  
FIG. 6 is a top view thereof;  
FIG. 7 is a bottom view thereof; and,  
FIG. 8 is a bottom, front perspective view thereof.  
The broken lines in the Figures show portions of the bottle that form no part of the claimed design.

**1 Claim, 7 Drawing Sheets**

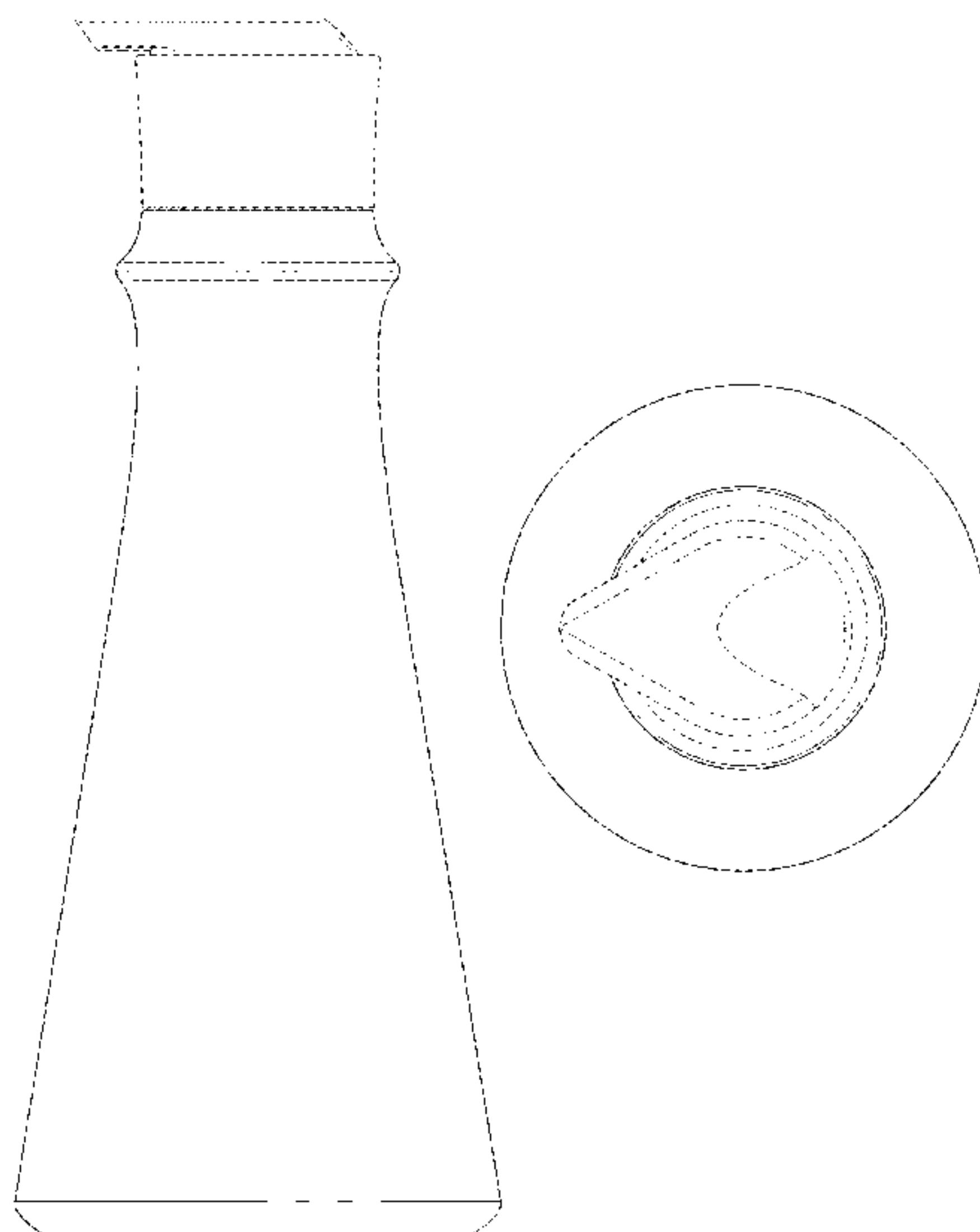

(56)

References Cited

U.S. PATENT DOCUMENTS

D234,747 S	4/1975	Sanders	
D240,897 S *	8/1976	McDonald	D9/500
D246,893 S *	1/1978	Eron	D9/689
4,124,148 A *	11/1978	Vieler et al.	222/321.8
D255,990 S *	7/1980	Lucas	D9/726
D263,807 S	4/1982	Kingsford	
D274,222 S *	6/1984	Markis	D9/504
D294,007 S *	2/1988	Mathias	D9/691
D323,455 S	1/1992	Eichler	
D386,412 S	11/1997	Heinz	
D409,051 S	5/1999	Huang	
D435,792 S	1/2001	Peloquin	
D438,116 S *	2/2001	Nosella	D9/500
D464,265 S	10/2002	Elliot et al.	
D472,147 S	3/2003	Herrmann	
D480,633 S *	10/2003	Miranda	D9/504
D484,055 S	12/2003	Feigenbaum	
D522,369 S	6/2006	Penn	
D538,177 S *	3/2007	Dretzka	D6/542
D538,474 S	3/2007	Sheppard et al.	
D541,167 S *	4/2007	Matsumura et al.	D9/558
D542,135 S	5/2007	Machmadow	
D563,222 S	3/2008	Yamanaka et al.	
D569,264 S	5/2008	Yamanaka et al.	
D577,126 S	9/2008	Woeste	
D583,240 S *	12/2008	Bourne	D9/500
D614,032 S	4/2010	Handy	
D616,261 S	5/2010	Lundstrom	
D616,262 S	5/2010	Lundstrom	
D620,807 S	8/2010	Wang Treadway et al.	
D654,795 S	2/2012	Handy	
D657,678 S *	4/2012	Heidel et al.	D9/516
D666,101 S	8/2012	Handy	
D673,452 S	1/2013	Handy	
D704,069 S *	5/2014	Handy	D9/685
2007/0040296 A1	2/2007	Moore	

\* cited by examiner

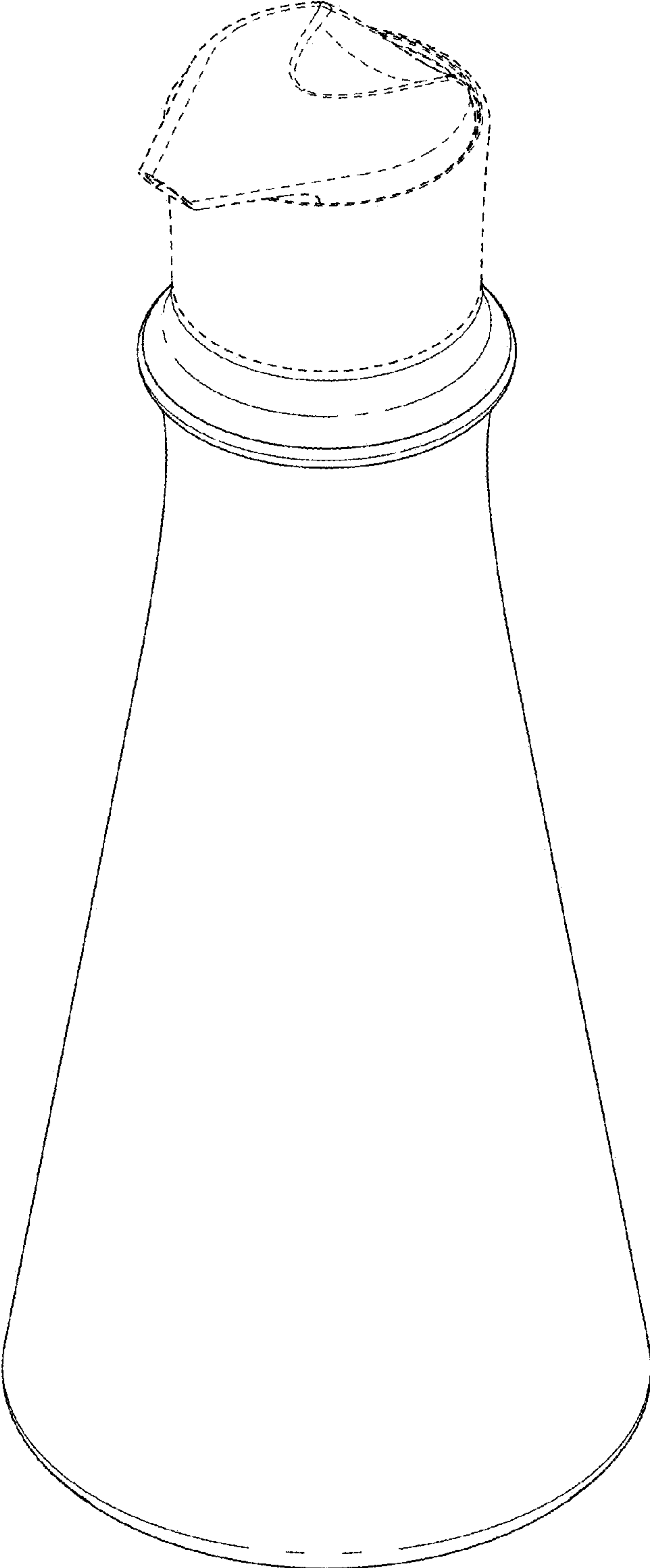

FIG. 1

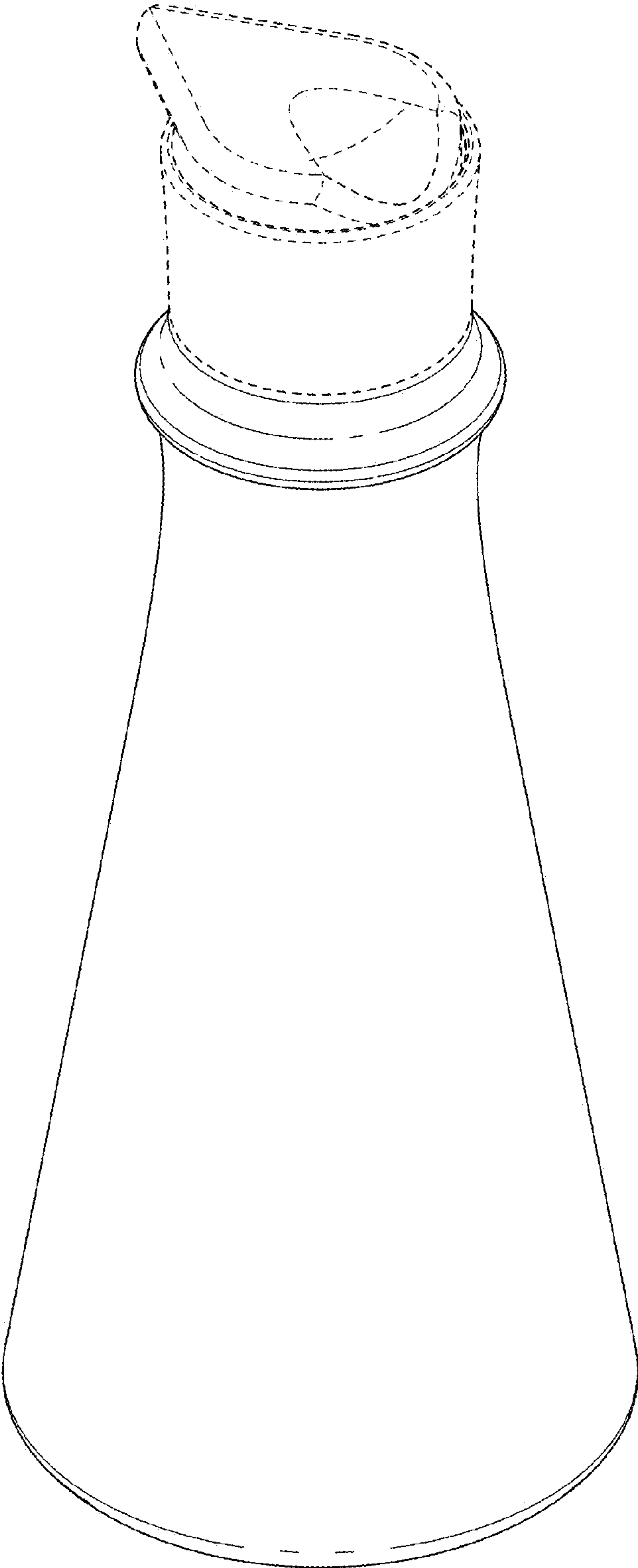

FIG. 2

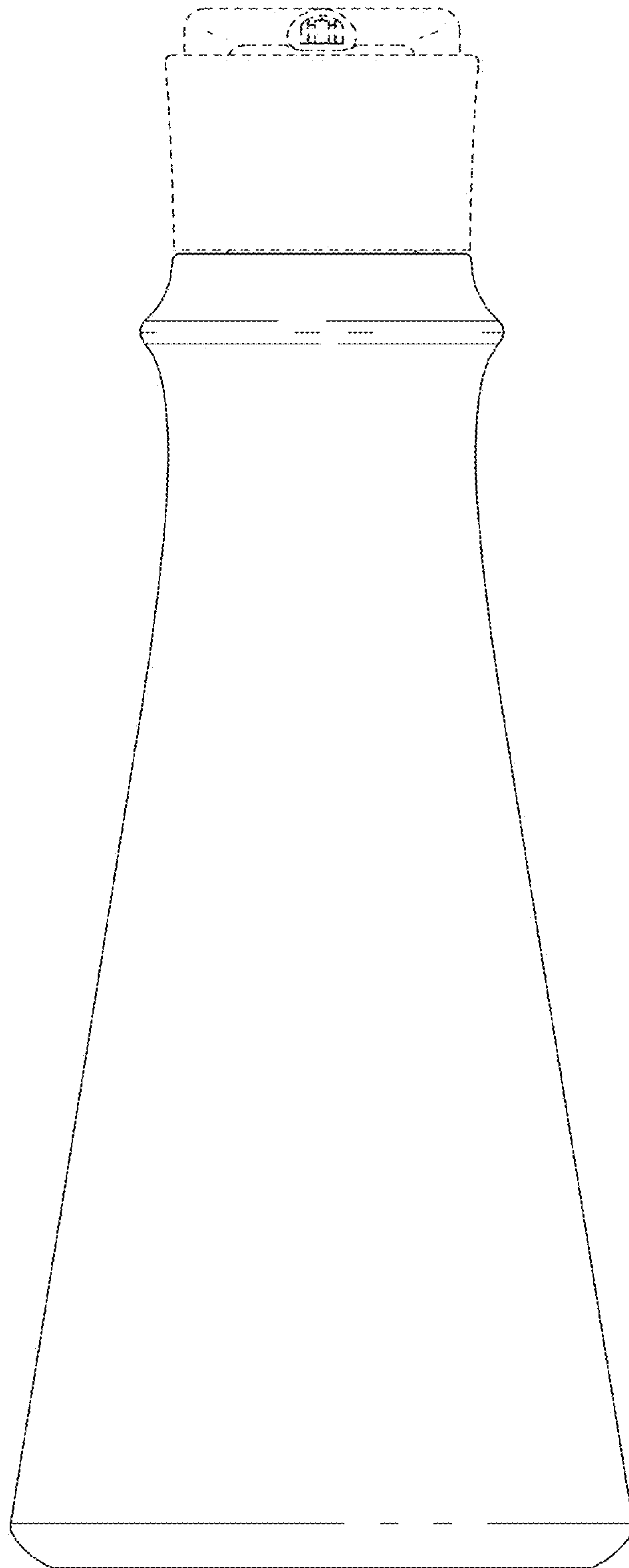

FIG. 3

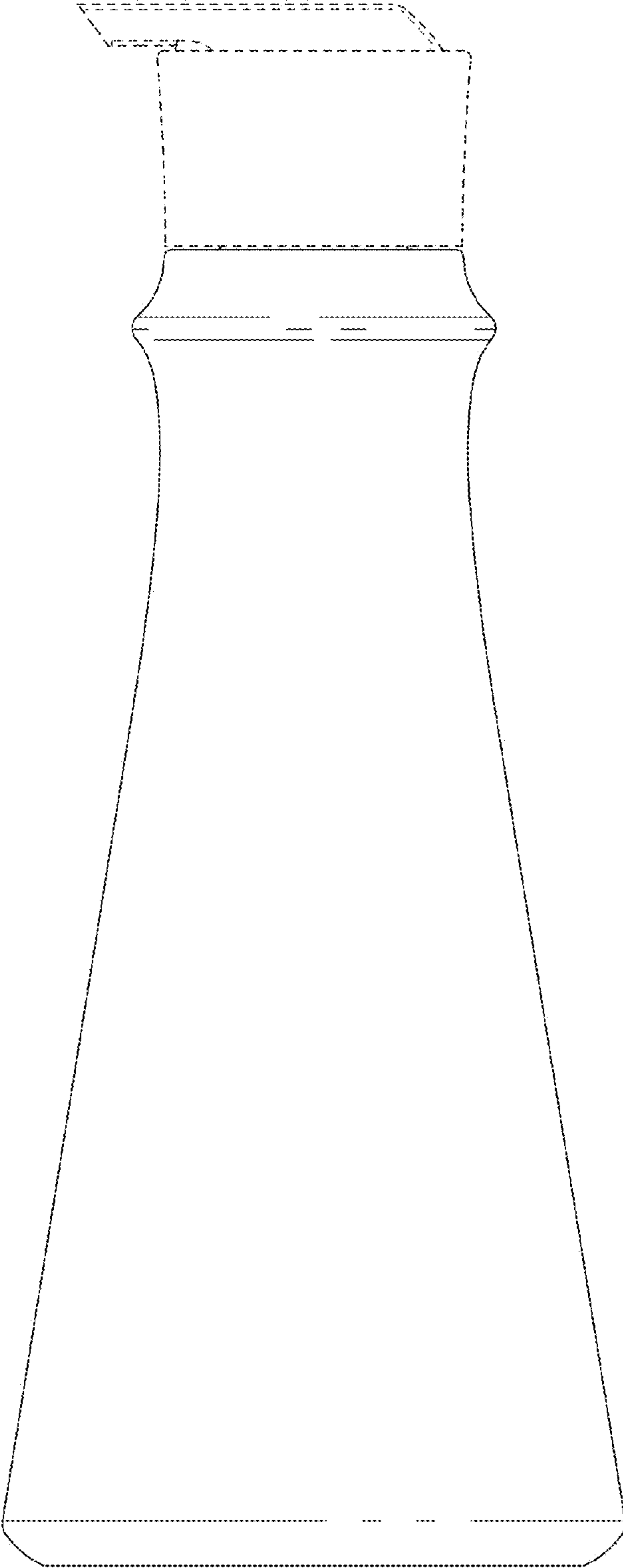

FIG. 4

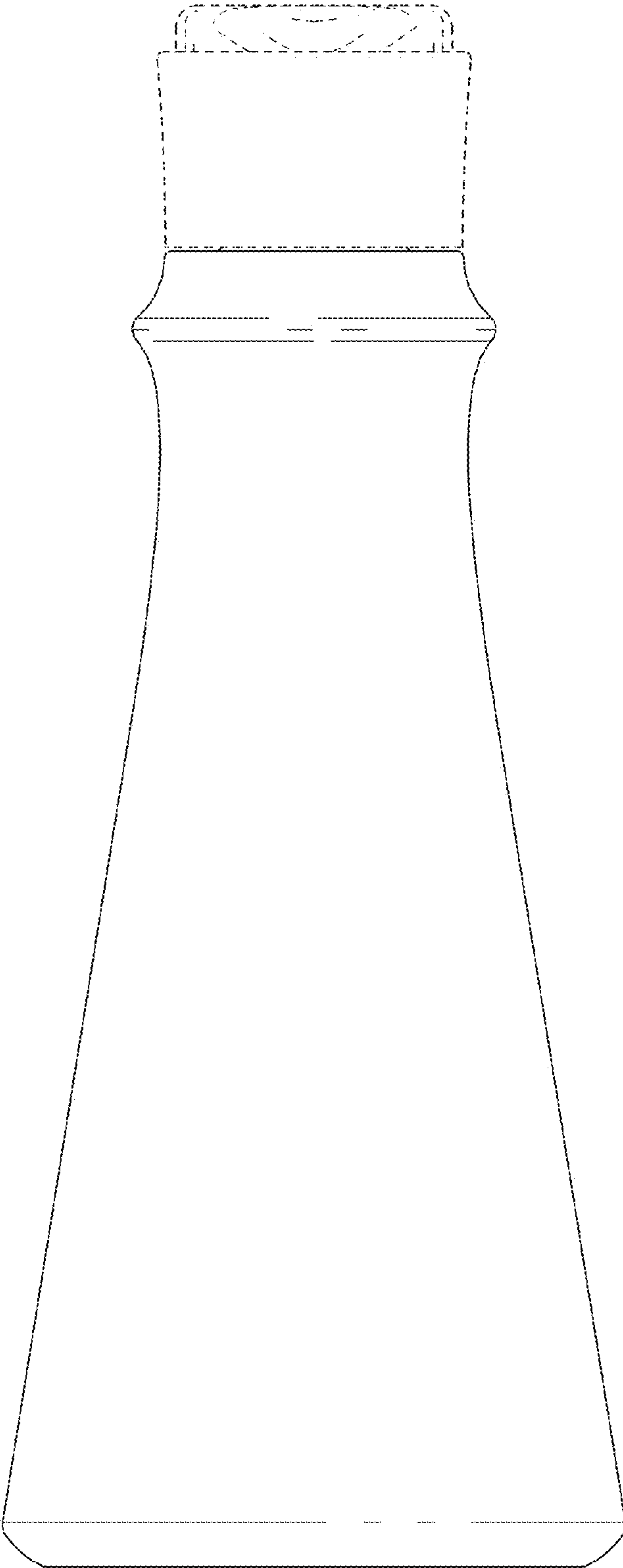

FIG. 5

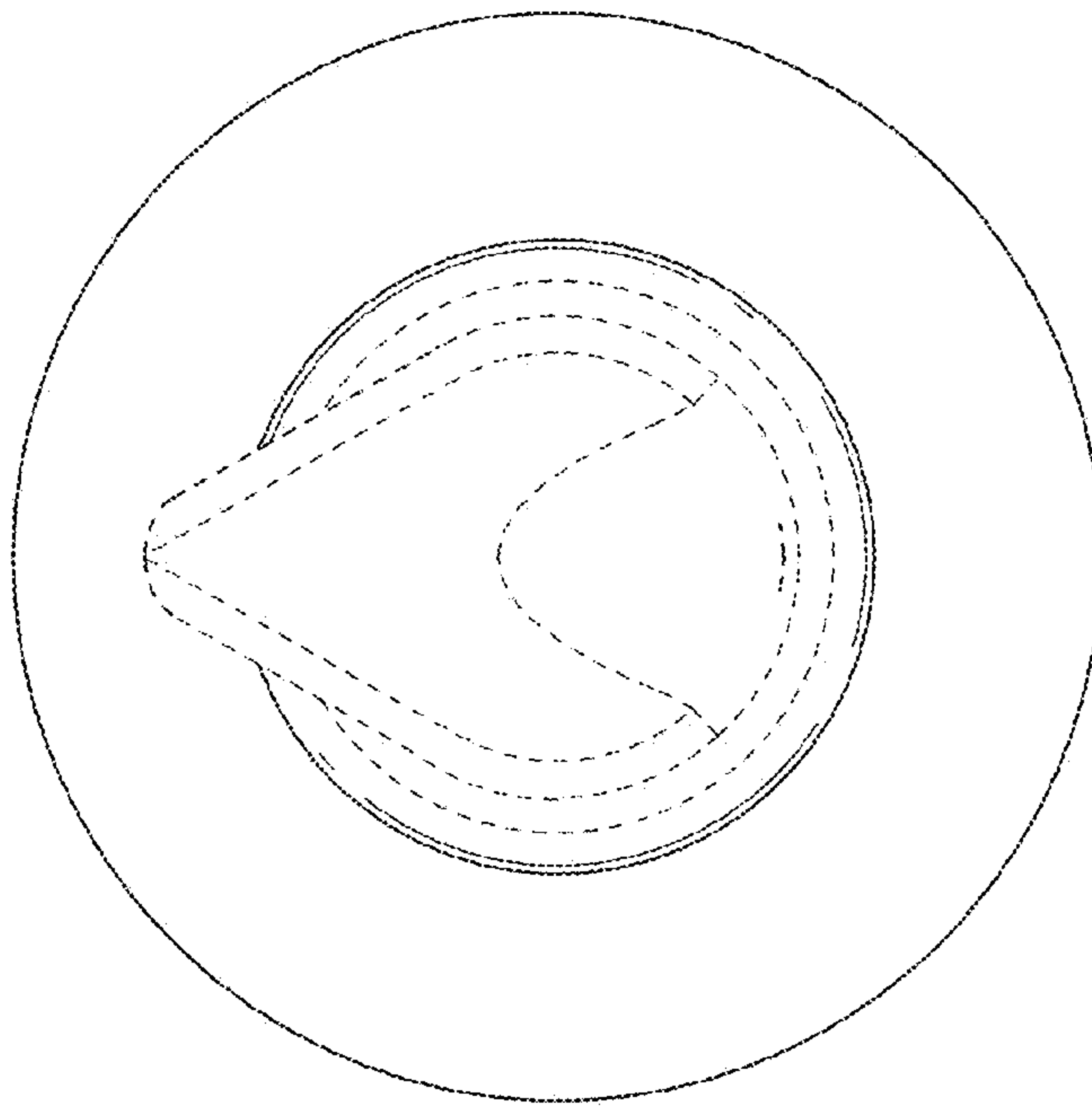

FIG. 6

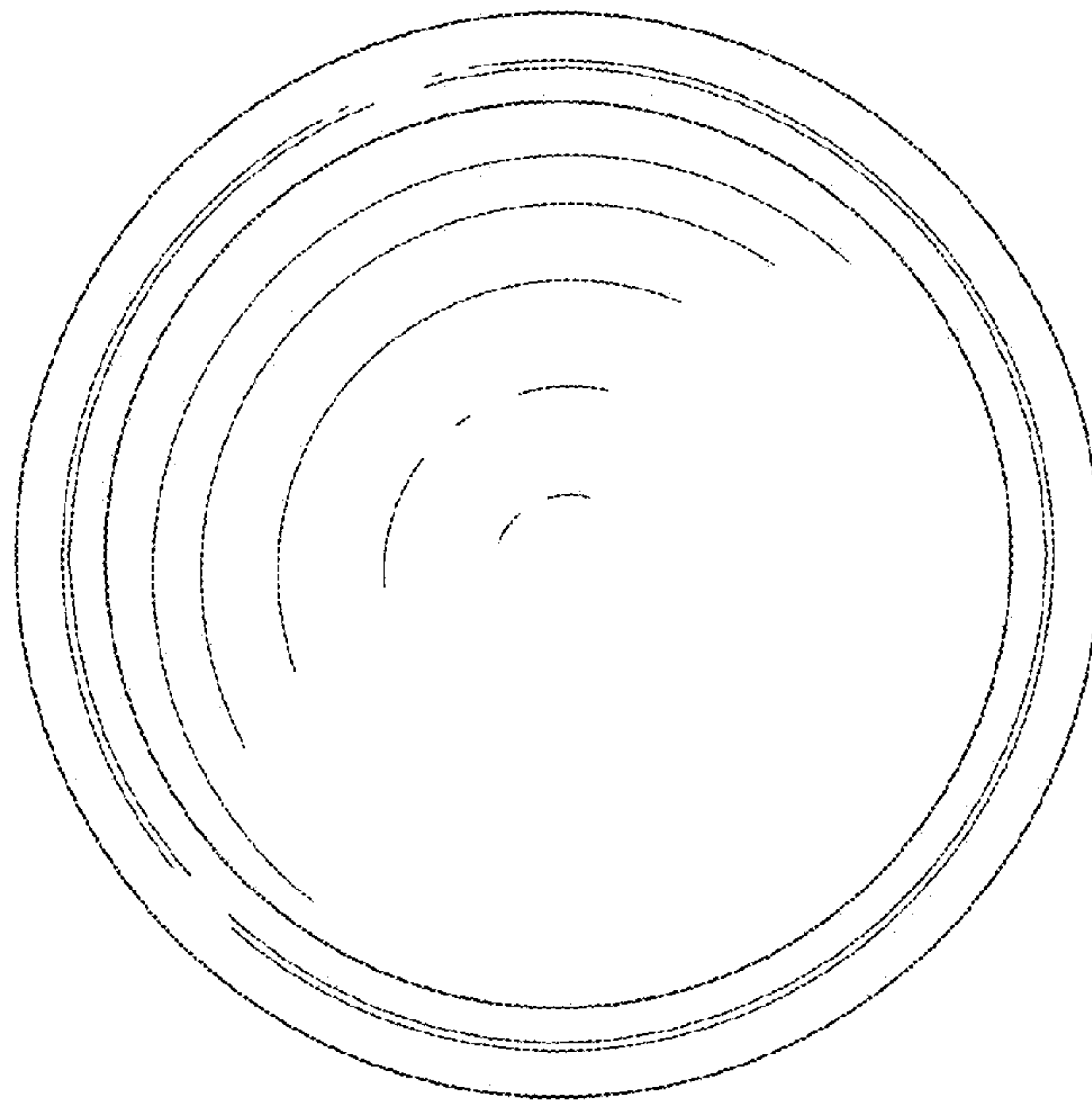

FIG. 7



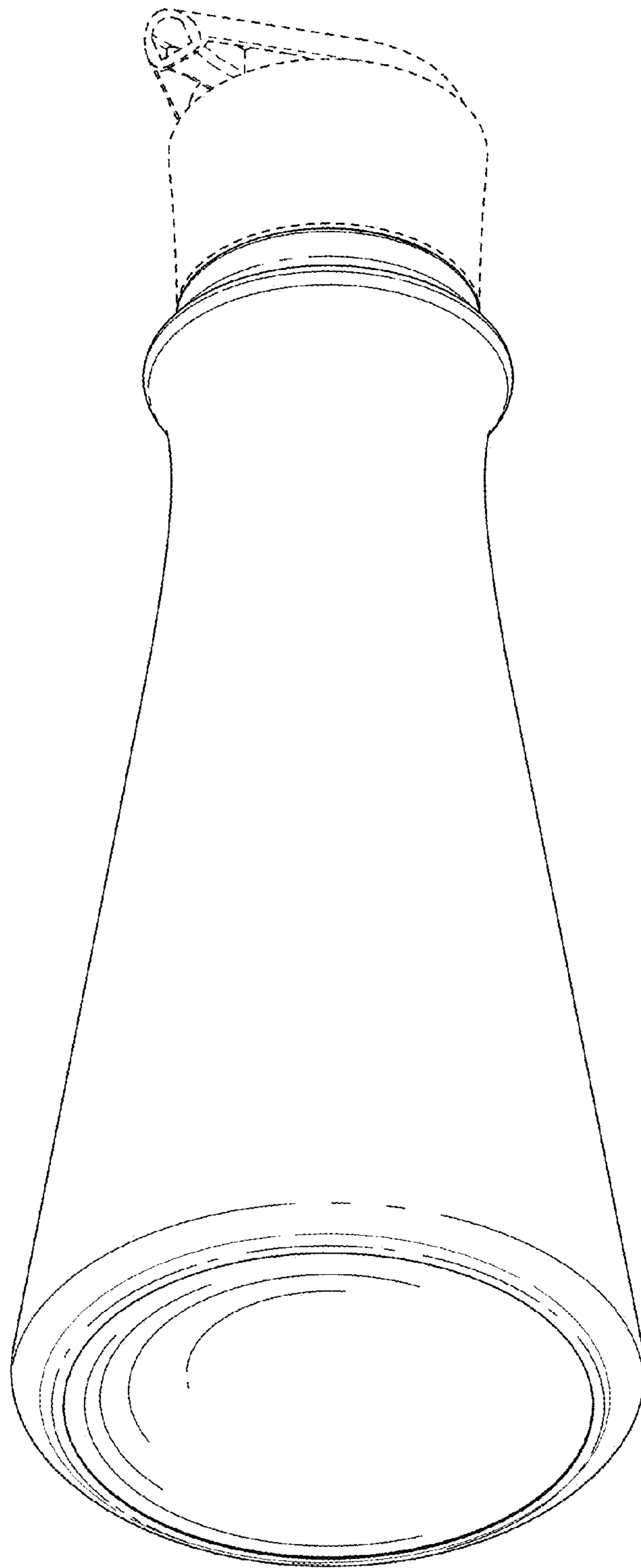

FIG. 8