



US00D712100S

(12) **United States Design Patent**  
**Aulwes et al.**

(10) **Patent No.:** **US D712,100 S**

(45) **Date of Patent:** **\*\* Aug. 26, 2014**

(54) **HANDLE FOR EQUINE TOOLS**

(75) Inventors: **Chad Aulwes**, Sterling, IL (US); **Helen Cox**, Sterling, IL (US)

(73) Assignee: **Wahl Clipper Corporation**, Sterling, IL (US)

(\*\*) Term: **14 Years**

(21) Appl. No.: **29/409,432**

(22) Filed: **Dec. 22, 2011**

(51) **LOC (10) Cl.** ..... **30-99**

(52) **U.S. Cl.**  
USPC ..... **D30/158; D4/138; D8/107**

(58) **Field of Classification Search**  
USPC ..... D30/158, 159, 199; D4/119, 122, 129, D4/137, 138, 199; D7/393, 395, 693; D8/83, 94, 107; D24/133; D28/73, 74, D28/29; D32/35, 40, 41, 42, 45, 51, 52; 15/104.002, 105, 209.1, 214, 230.11, 15/235.4, 167.1; 119/600, 601, 615, 625, 119/633; 16/430

See application file for complete search history.

(56) **References Cited**

**U.S. PATENT DOCUMENTS**

D118,810 S *	2/1940	Berry	.....	D28/29
D144,192 S *	3/1946	Kahler	.....	D7/695
2,800,879 A *	7/1957	Quick	.....	119/631
D180,780 S *	8/1957	Halberstadt	.....	D4/138
D374,795 S *	10/1996	Lie	.....	D7/395
6,065,188 A *	5/2000	Wold et al.	.....	16/430
D439,056 S *	3/2001	Woodnorth et al.	.....	D4/138
D449,909 S *	10/2001	Randolph et al.	.....	D32/40
D453,450 S *	2/2002	Drummond	.....	D7/693
D481,836 S *	11/2003	Simon	.....	D30/158
D495,498 S *	9/2004	Berti	.....	D4/138
D506,040 S *	6/2005	Swyst et al.	.....	D30/158
D509,033 S *	8/2005	Dotterman et al.	.....	D32/51

D535,174 S *	1/2007	Chen	.....	D8/107
D597,787 S *	8/2009	Jalet et al.	.....	D7/395
D607,708 S *	1/2010	Himbert et al.	.....	D8/107
D610,756 S *	2/2010	Lin	.....	D30/159
D629,209 S *	12/2010	Taggart et al.	.....	D4/138
D635,432 S *	4/2011	Nakonechny et al.	.....	D8/107
2011/0297102 A1 *	12/2011	Wang	.....	119/631

\* cited by examiner

*Primary Examiner* — Caron D Veynar

*Assistant Examiner* — Martie K Holtje

(74) *Attorney, Agent, or Firm* — Greer, Burns & Crain, Ltd.

(57) **CLAIM**

The ornamental design for a handle for equine tools, as shown and described.

**DESCRIPTION**

FIG. 1 is a top perspective view of a handle for equine tools showing our new design;  
 FIG. 2 is a top plan view thereof;  
 FIG. 3 is a bottom plan view thereof;  
 FIG. 4 is a right side view thereof;  
 FIG. 5 is a left side view thereof;  
 FIG. 6 is a front view thereof;  
 FIG. 7 is a rear view thereof;  
 FIG. 8 is a top perspective view of the design of FIG. 1 shown in an alternate environment;  
 FIG. 9 is a top plan view of FIG. 8;  
 FIG. 10 is a bottom plan view of FIG. 8;  
 FIG. 11 is a right side view of FIG. 8;  
 FIG. 12 is a left side view of FIG. 8;  
 FIG. 13 is a front view of FIG. 8; and,  
 FIG. 14 is a rear view of FIG. 8.

The structural elements depicted by broken lines have been shown for the purpose of illustrating portions of, and environmental features of, the handle for equine tools that form no part of the claimed design.

**1 Claim, 10 Drawing Sheets**

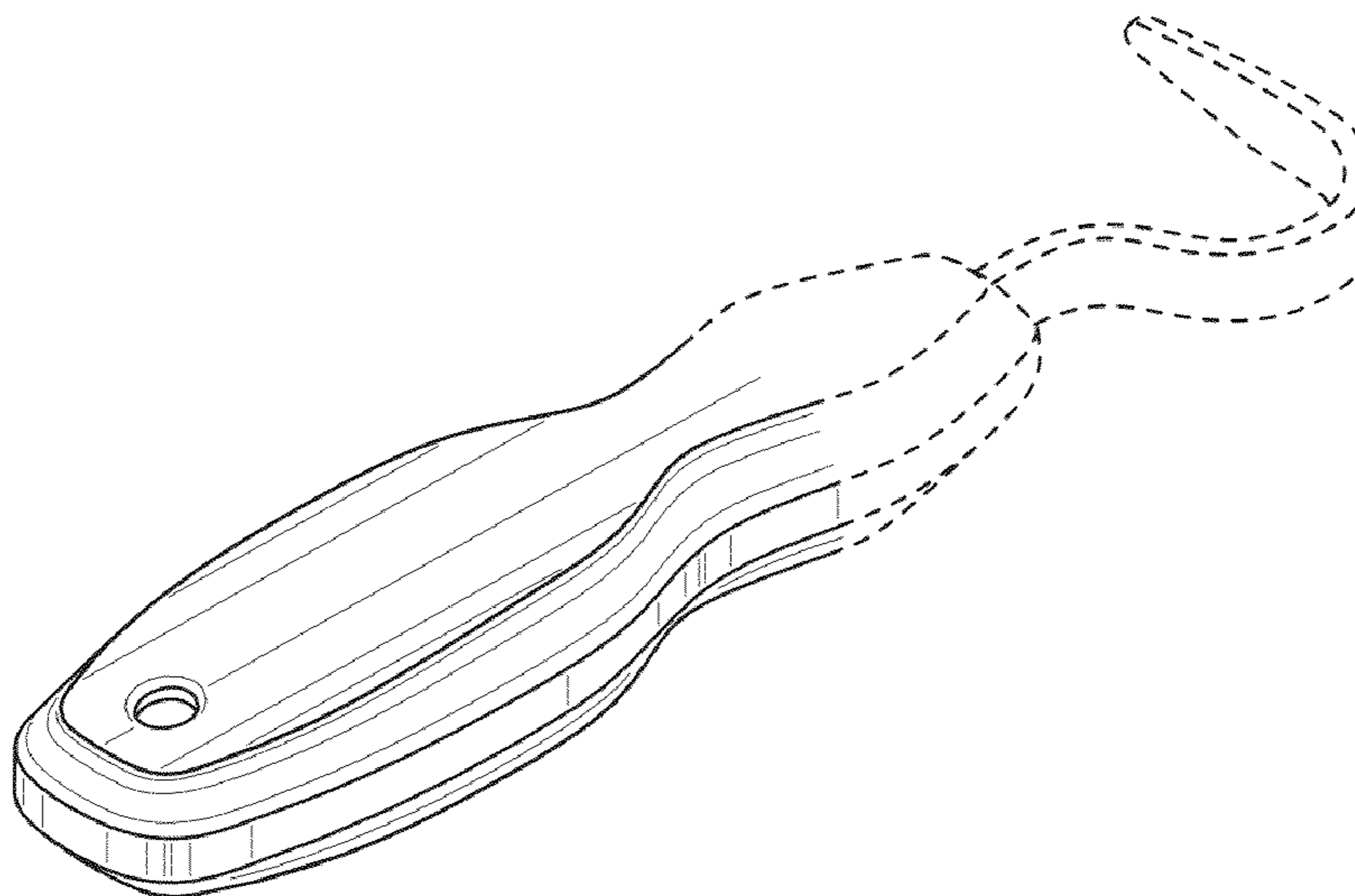

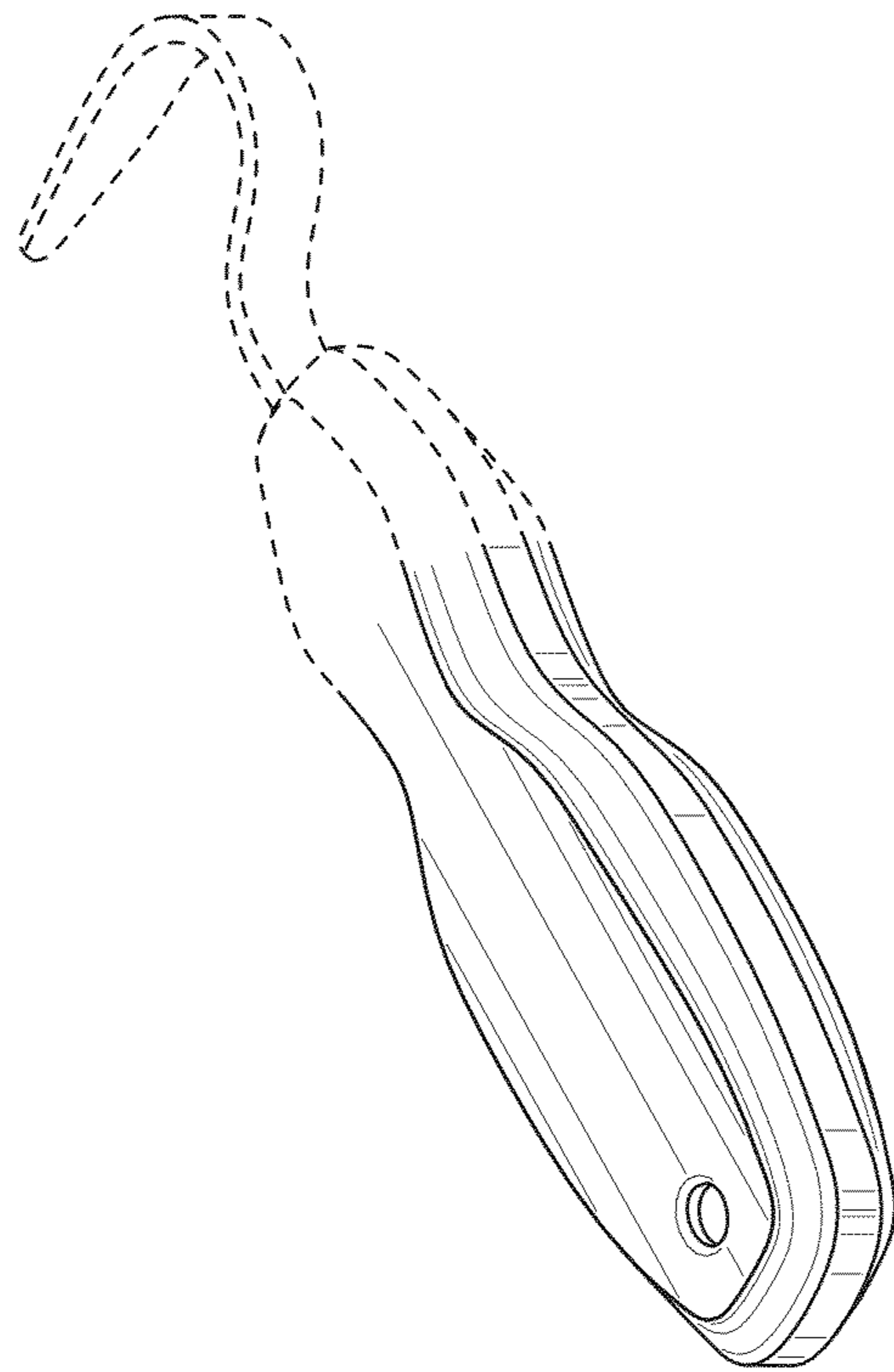

FIG. 1

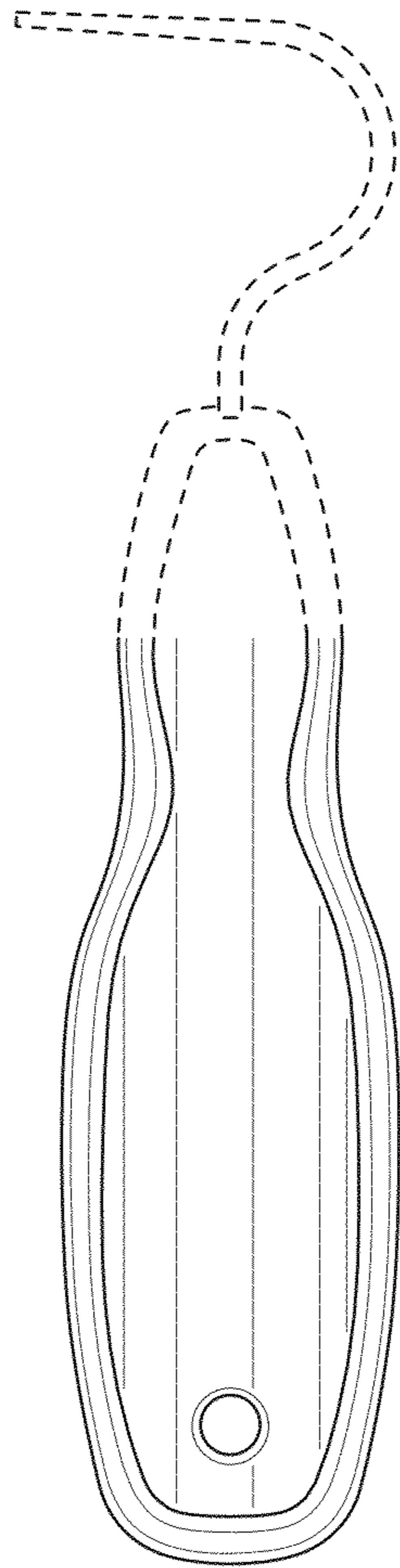

FIG. 2

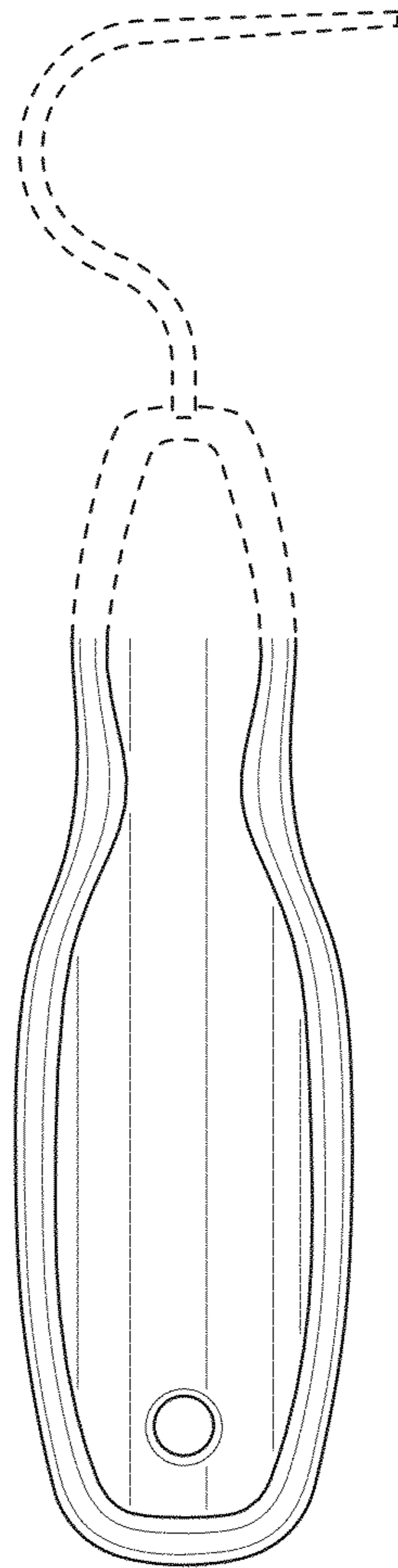

FIG. 3

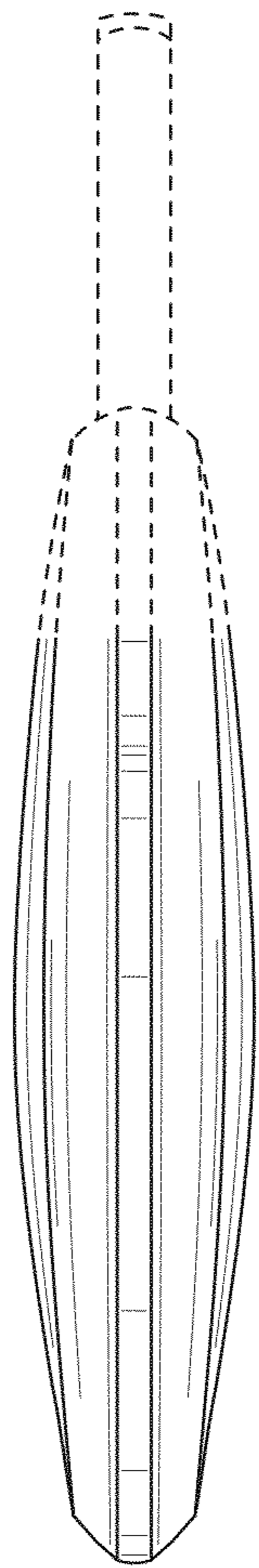

FIG. 4

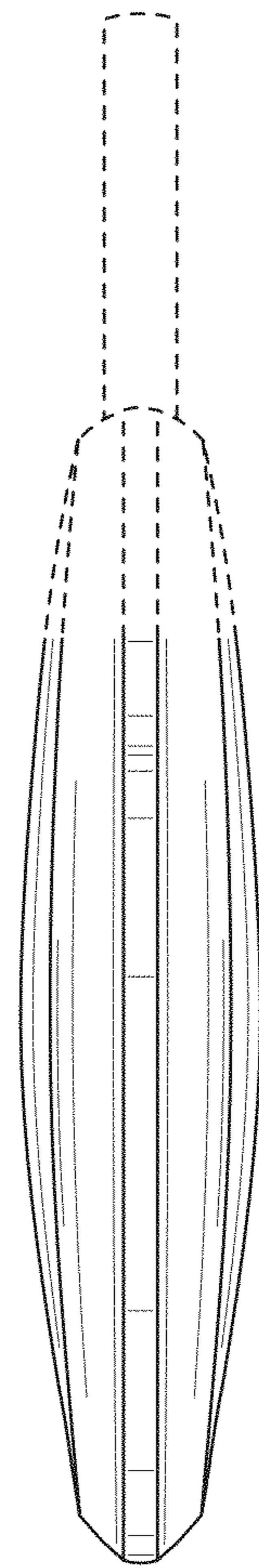

FIG. 5

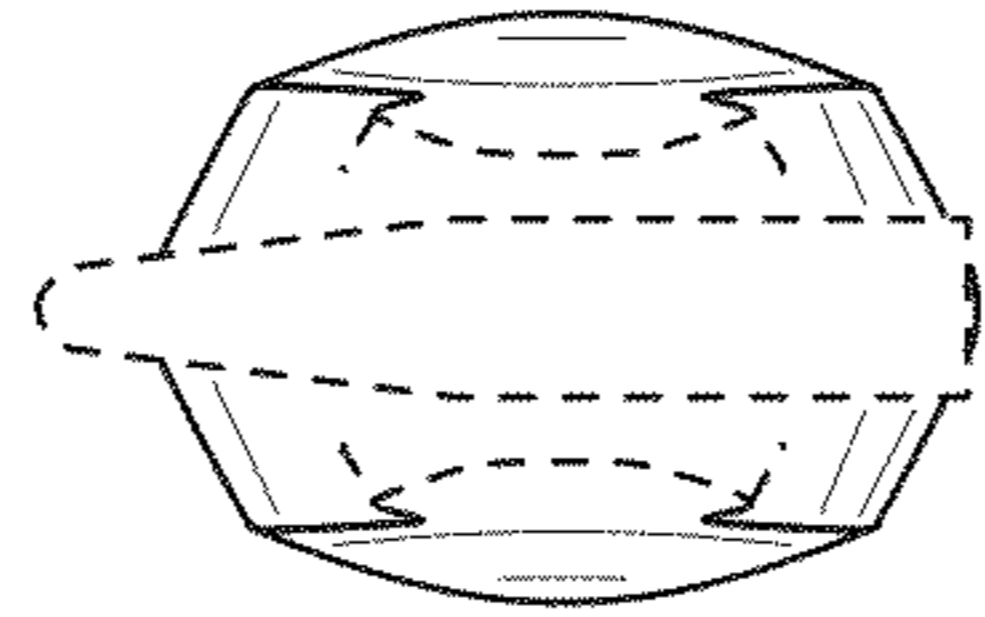

FIG. 6

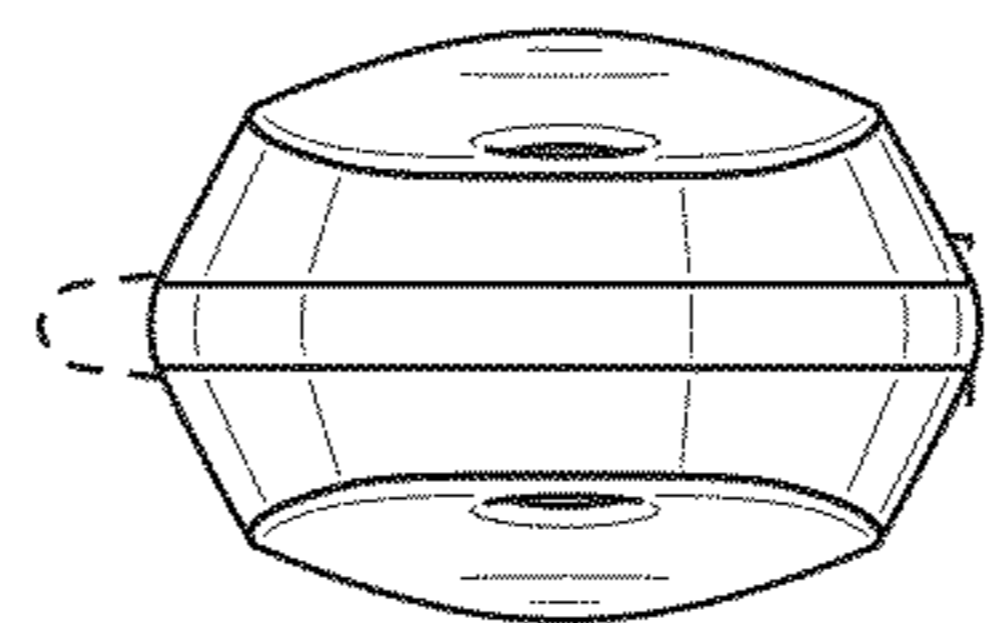

FIG. 7



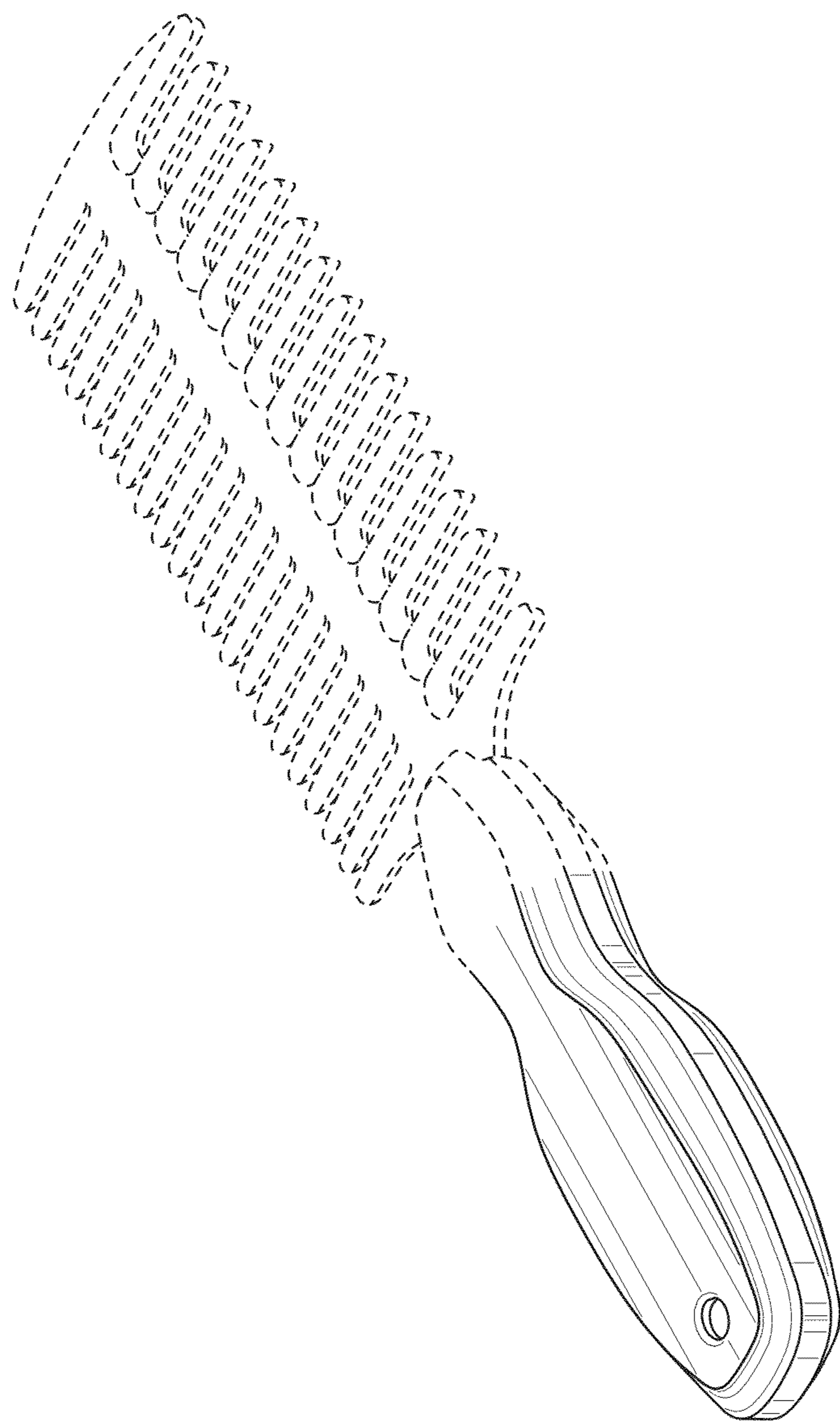

FIG. 8

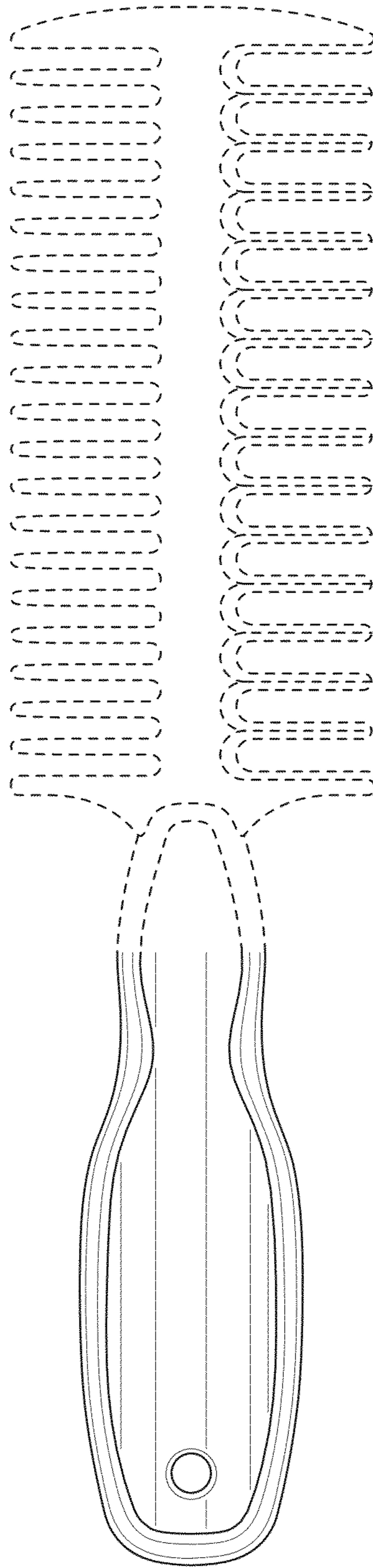

FIG. 9



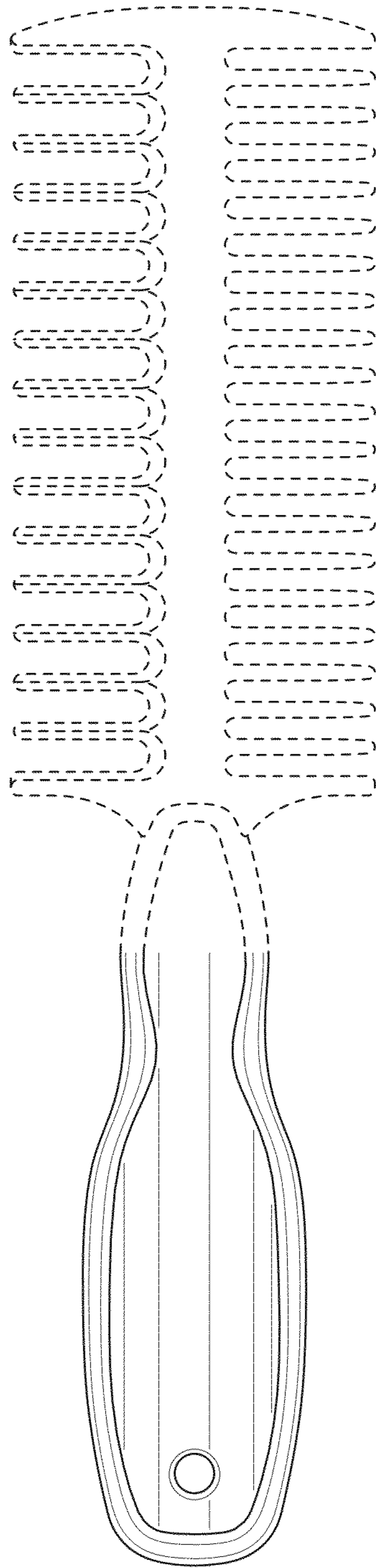

FIG. 10

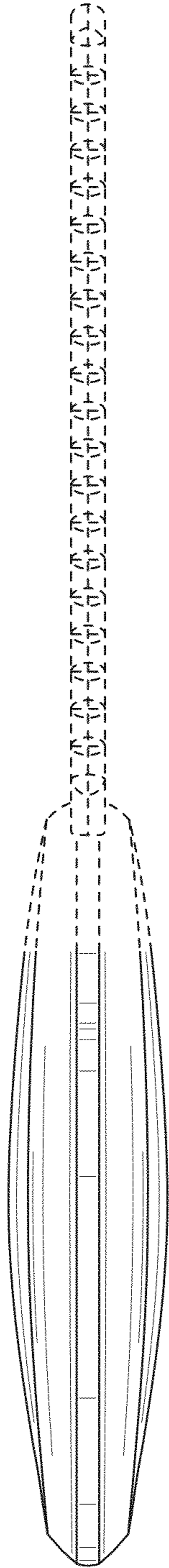

FIG. 11

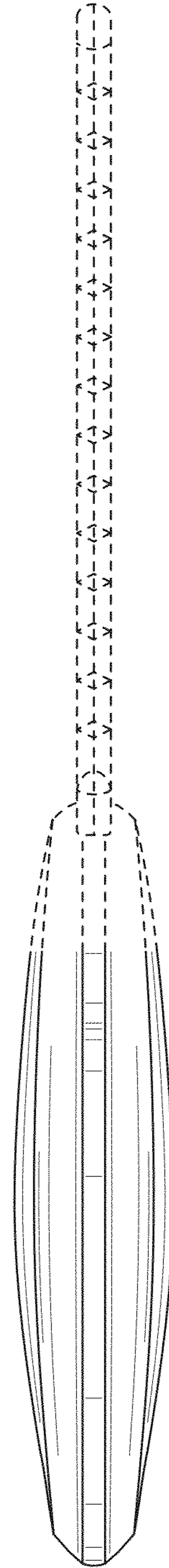

FIG. 12

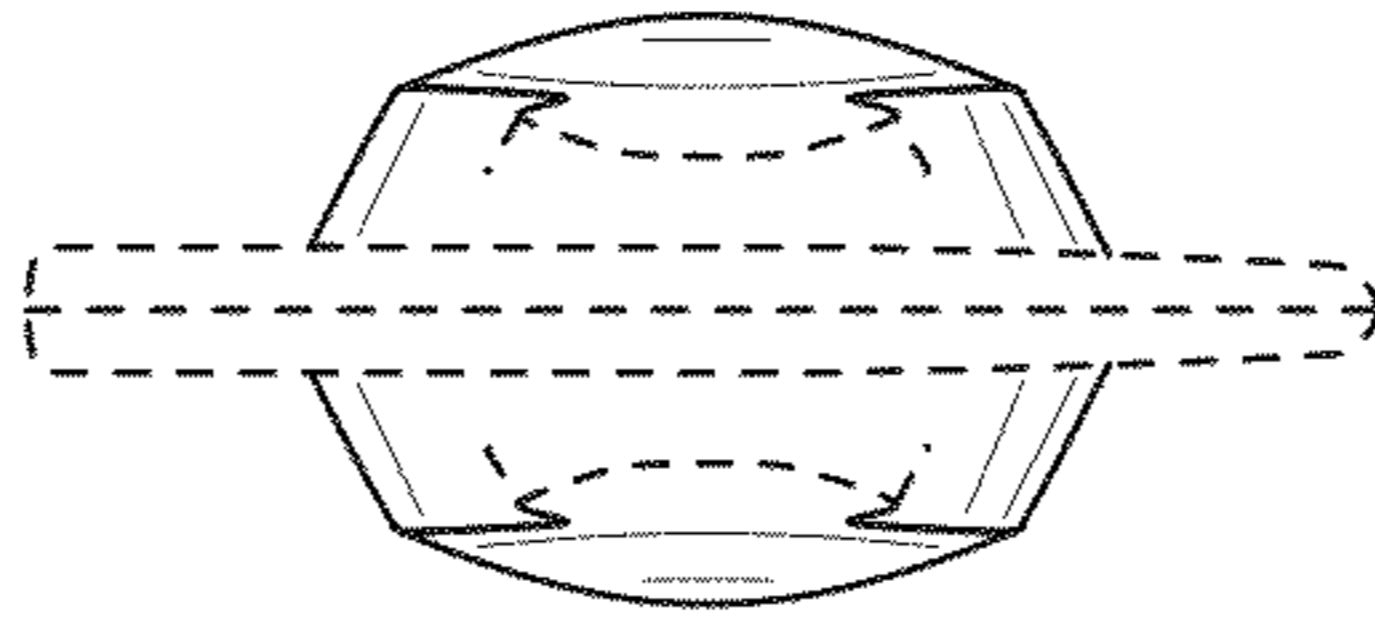

FIG. 13

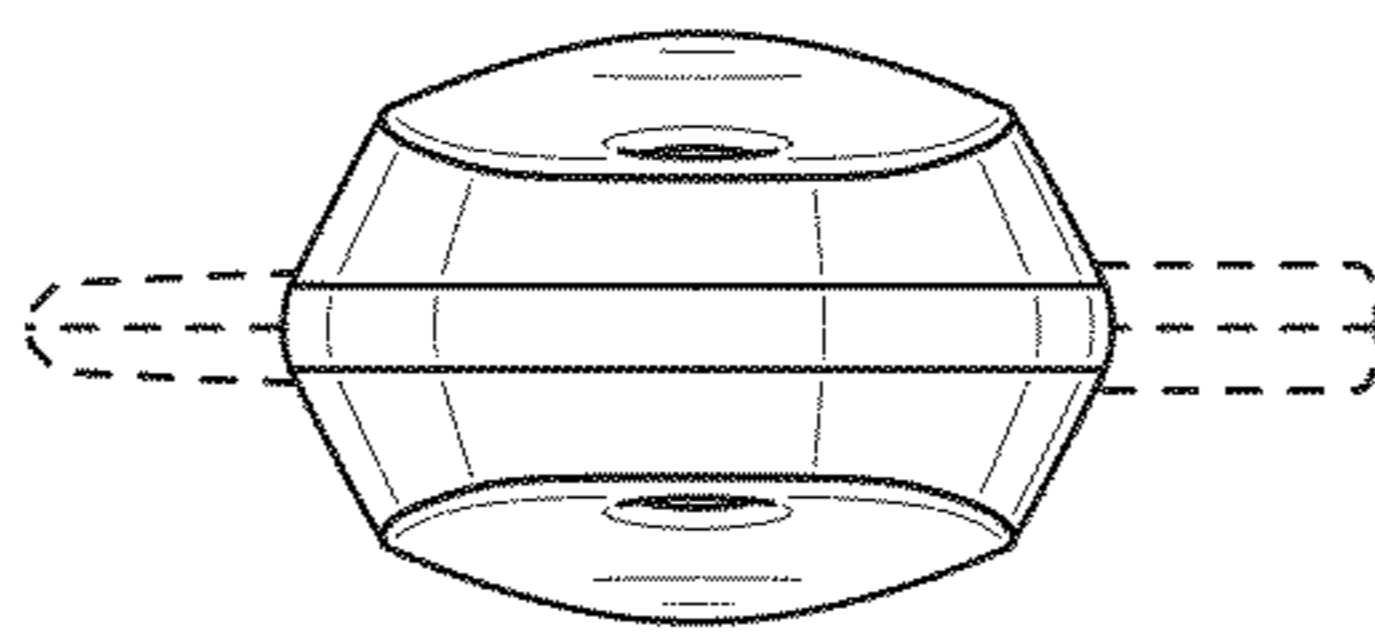

FIG. 14