



US00D712005S

(12) **United States Design Patent**
De Luna

(10) **Patent No.:** **US D712,005 S**

(45) **Date of Patent:** **** Aug. 26, 2014**

(54) **FISHING LURE CARRYING CASE**

D586,876 S * 2/2009 Kern D22/134
D620,254 S * 7/2010 Noraker D3/260
D663,378 S * 7/2012 Osman D22/134

(71) Applicant: **Rogelio Hernandez De Luna**, Pipe
Creek, TX (US)

* cited by examiner

(72) Inventor: **Rogelio Hernandez De Luna**, Pipe
Creek, TX (US)

Primary Examiner — Catheri Oliver-Garcia

(74) *Attorney, Agent, or Firm* — Christopher L. Makay

(**) Term: **14 Years**

(57) **CLAIM**

The ornamental design for a fishing lure carrying case, as shown and described.

(21) Appl. No.: **29/442,646**

DESCRIPTION

(22) Filed: **Apr. 10, 2013**

(51) **LOC (10) Cl.** **22-05**

(52) **U.S. Cl.**
USPC **D22/139; D3/260**

(58) **Field of Classification Search**
CPC A01K 97/06; A01K 97/04
USPC D22/134, 139; D3/260, 294, 905;
43/25.2, 25-26, 54.1, 57.1; 206/315.11
See application file for complete search history.

FIG. 1 is a perspective view illustrating a closed position of the fishing lure carrying case according to my new design; FIG. 2 is a top view thereof; FIG. 3 is a front view thereof; FIG. 4 is a left side view thereof; FIG. 5 is a right side view thereof; FIG. 6 is a rear view thereof; FIG. 7 is a bottom view thereof. FIG. 8 is a perspective view illustrating an open position of the fishing lure carrying case; FIG. 9 is a top view illustrating a fishing lure stored within the fishing lure carrying case; and, FIG. 10 is a perspective view illustrating the storing of a fishing lure within the fishing lure carrying case and the securing of the fishing lure carrying case to a fishing pole. The broken line showing of environment in the drawings is included for the purpose of illustrating only and forms no part of the claimed design.

(56) **References Cited**

U.S. PATENT DOCUMENTS

2,849,825 A * 9/1958 Reisner 43/25.2
4,015,361 A * 4/1977 O'Reilly et al. 43/25.2
4,216,604 A * 8/1980 Starke 43/25.2
5,233,783 A * 8/1993 Roebuck et al. 43/25.2
D373,614 S * 9/1996 Bevill D22/139
D399,912 S * 10/1998 Kopp, III D22/126
D405,499 S * 2/1999 Beauvais D22/139
D475,432 S * 6/2003 LaLande D22/126

1 Claim, 4 Drawing Sheets

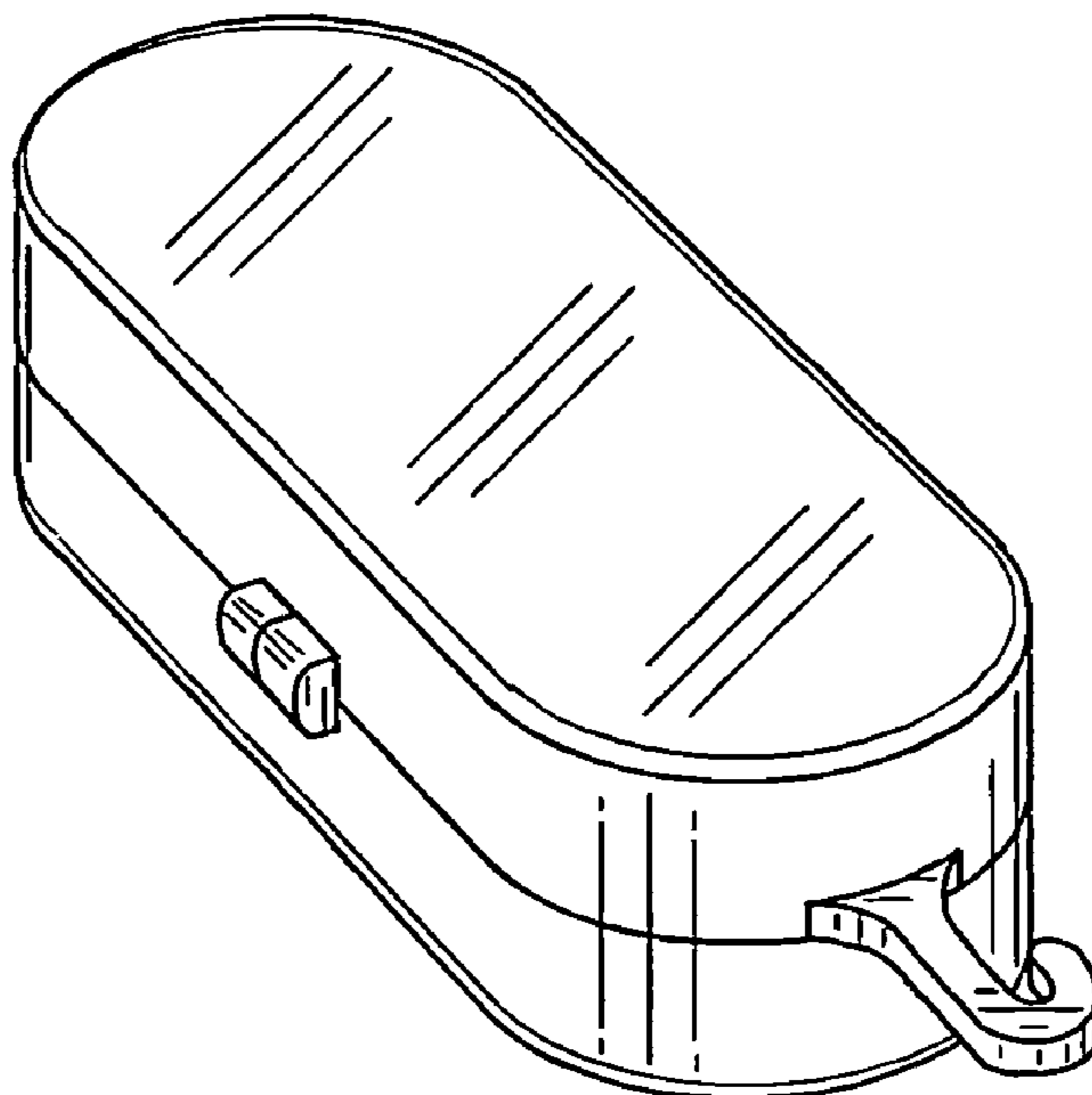

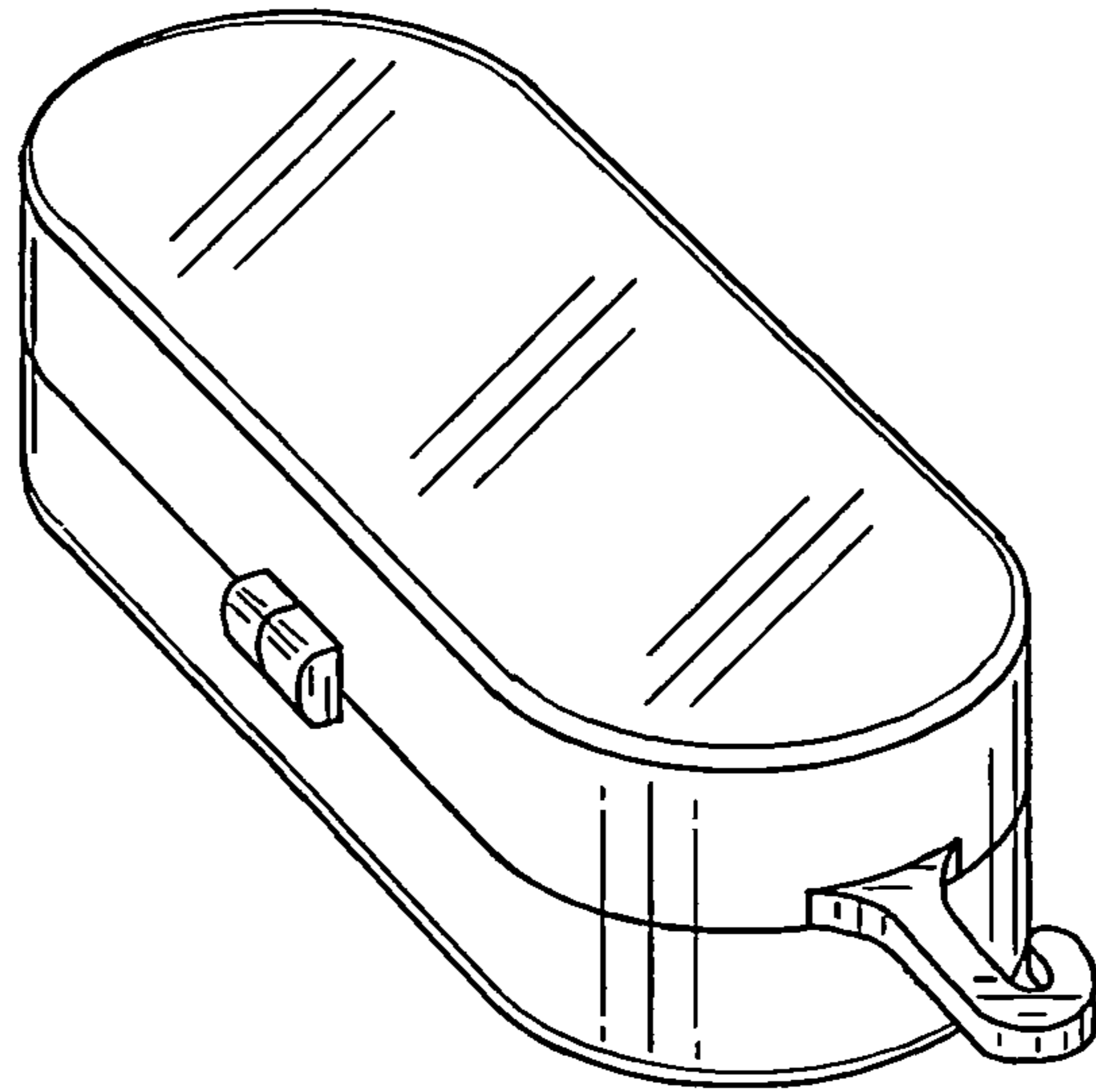

Fig. 1

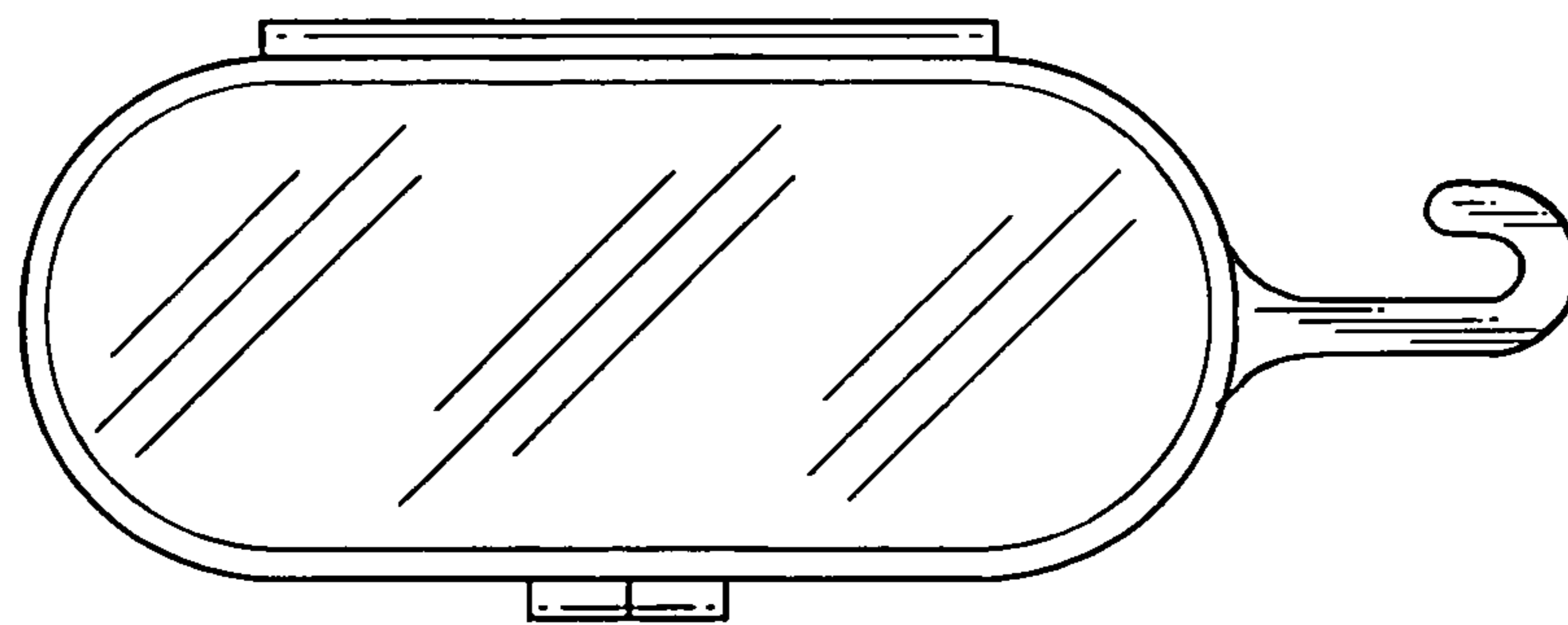

Fig. 2

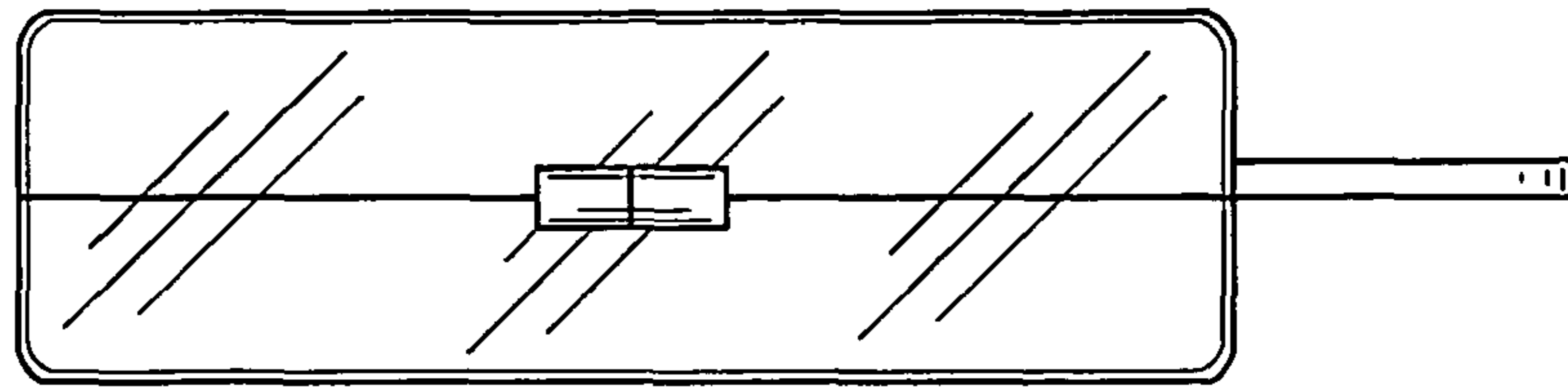

Fig. 3

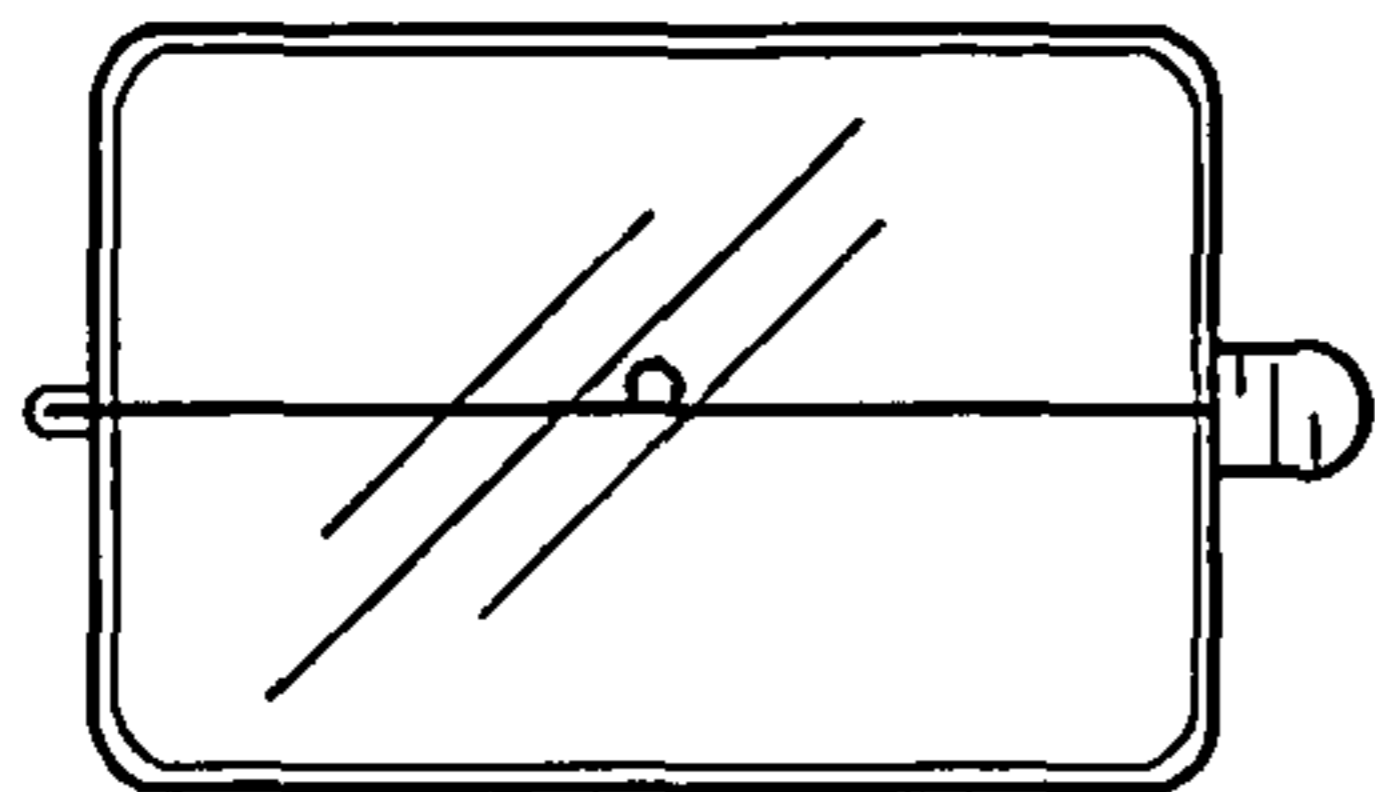

Fig. 4

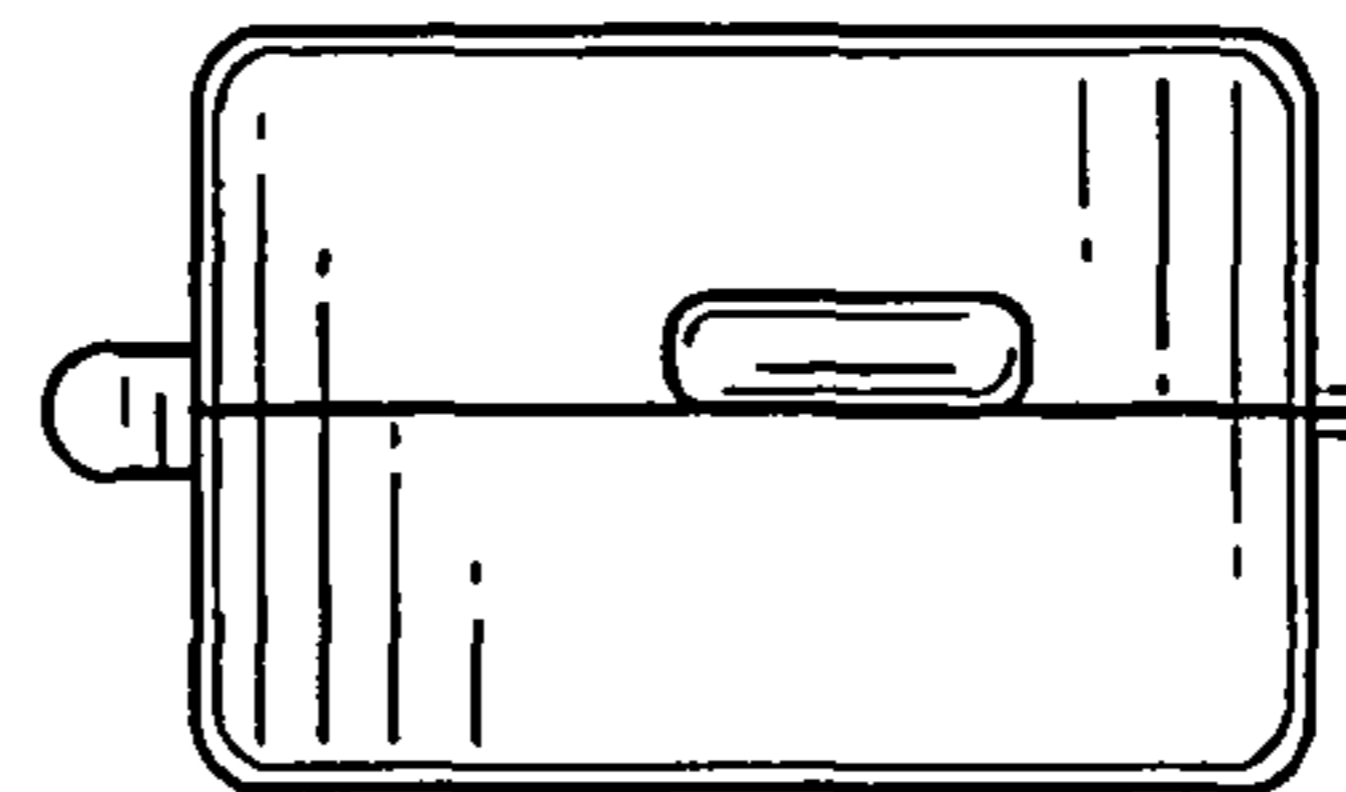

Fig. 5

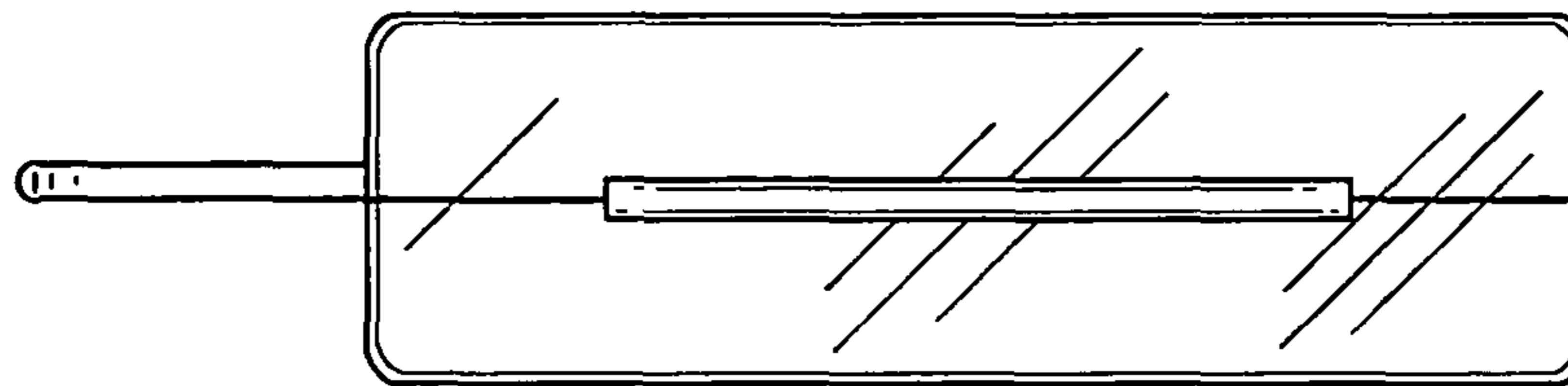

Fig. 6

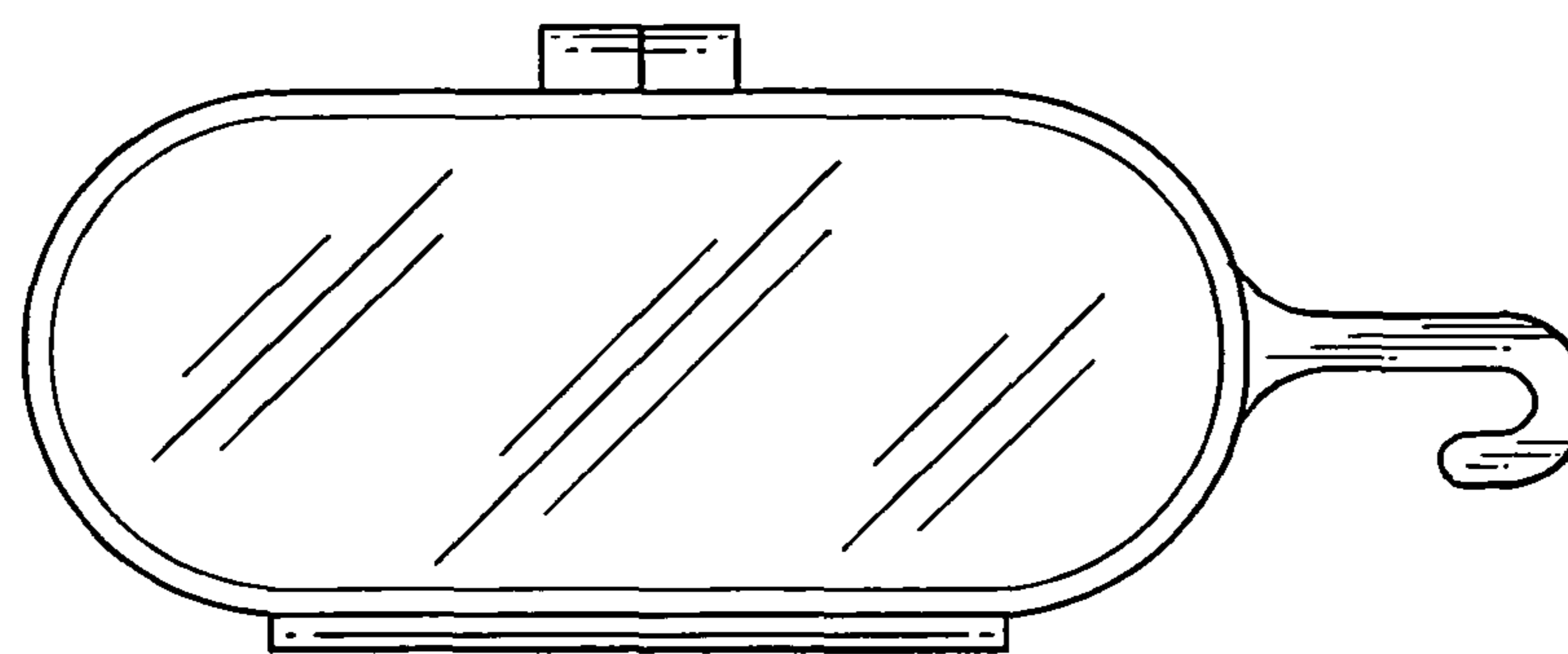

Fig. 7

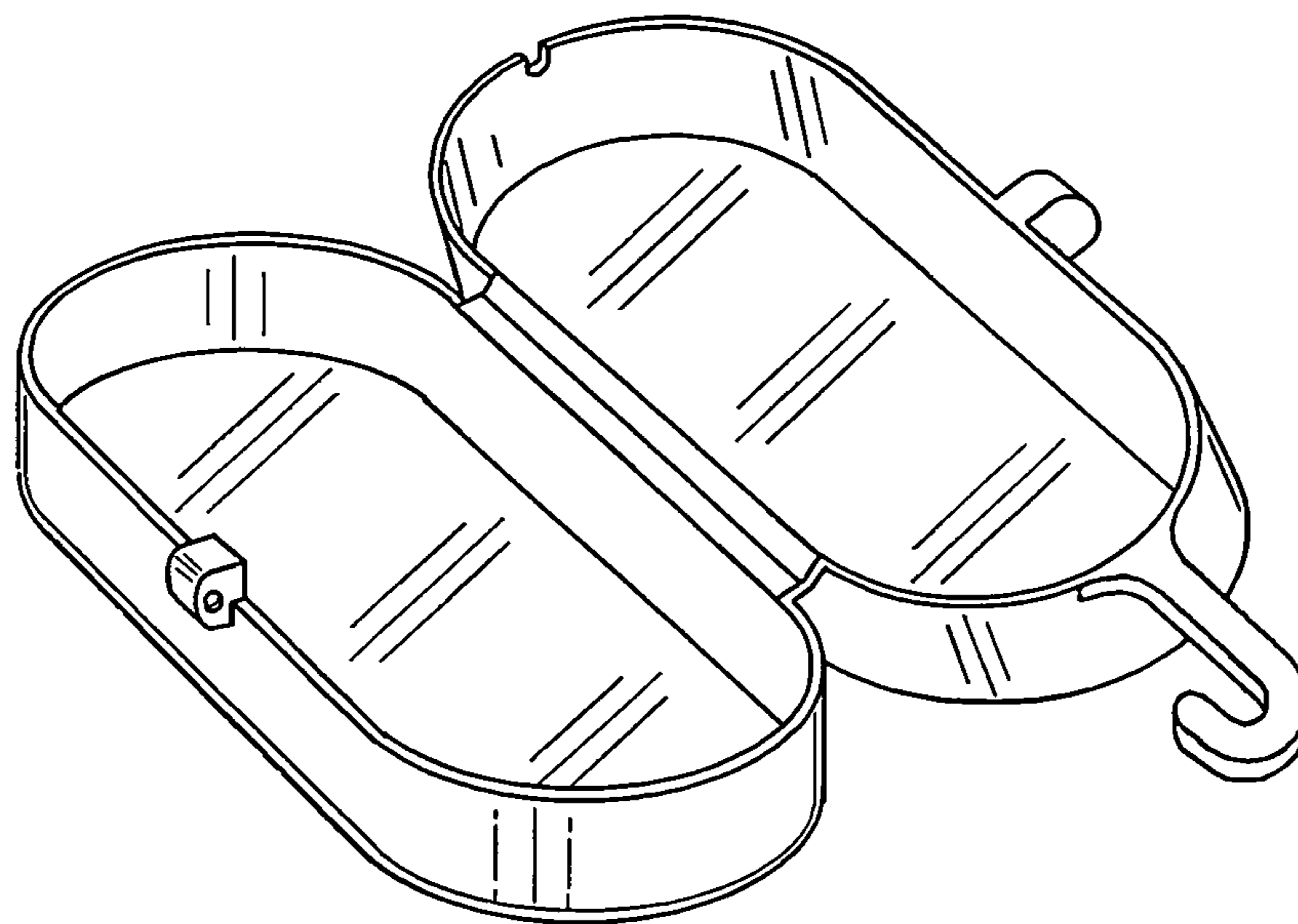

Fig. 8

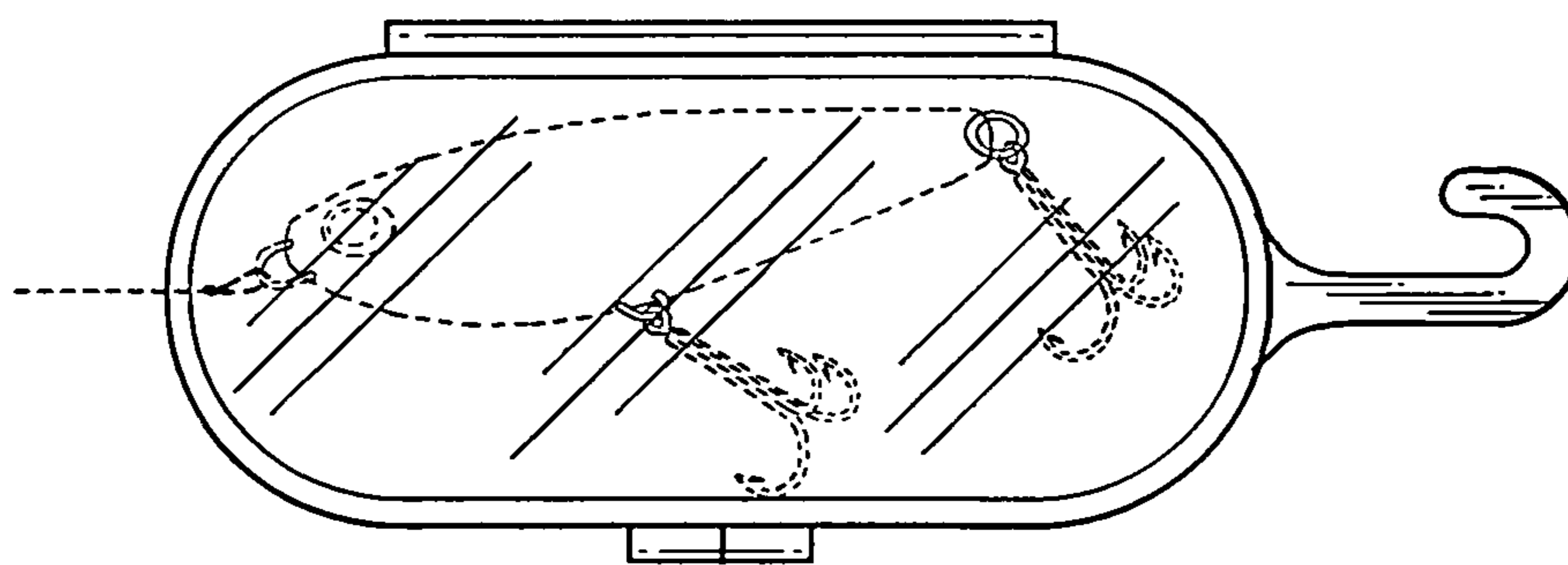

Fig. 9

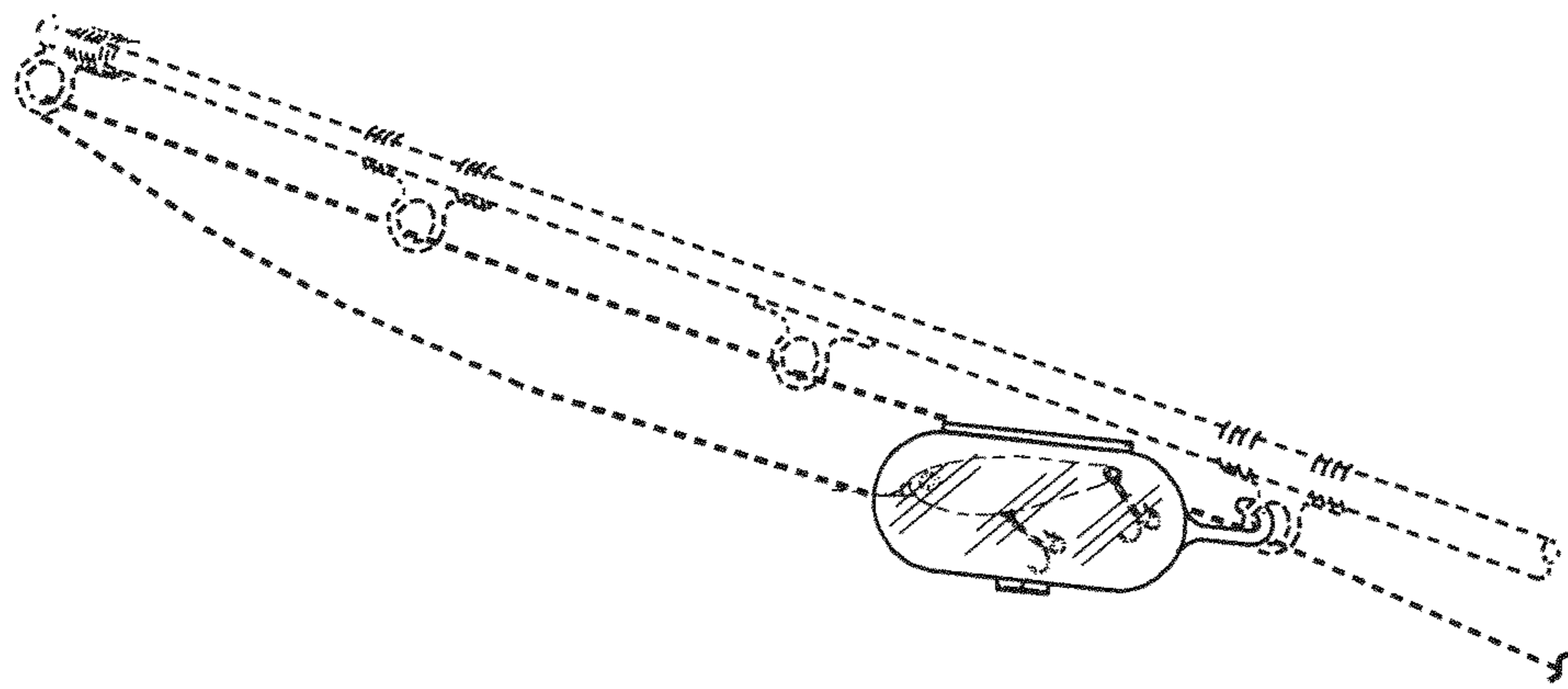

Fig. 10