



US00D711942S

(12) **United States Design Patent**
Jeon et al.

(10) **Patent No.:** **US D711,942 S**

(45) **Date of Patent:** **** Aug. 26, 2014**

(54) **REFRIGERATOR**

(71) Applicant: **Samsung Electronics Co., Ltd.**,
Suwon-si (KR)

(72) Inventors: **Sang-Woon Jeon**, Namyangju-si (KR);
Sun-Min Lee, Seoul (KR); **Se-Youn**
Park, Incheon (KR); **Jae-Moon Lee**,
Seoul (KR)

(73) Assignee: **Samsung Electronics Co., Ltd.** (KR)

(**) Term: **14 Years**

(21) Appl. No.: **29/459,334**

(22) Filed: **Jun. 28, 2013**

(30) **Foreign Application Priority Data**

Jan. 3, 2013 (KR) 30-2013-0000214

(51) **LOC (10) Cl.** **15-07**

(52) **U.S. Cl.**
USPC **D15/89**

(58) **Field of Classification Search**
USPC D15/79-89, 91; 62/98, 344, 389;
141/351, 86, 361, 362; 222/108, 146.6
See application file for complete search history.

(56) **References Cited**

U.S. PATENT DOCUMENTS

D365,579 S * 12/1995 Baker et al. D15/89
5,474,213 A * 12/1995 Unger 222/108
D367,659 S * 3/1996 Baker et al. D15/89
5,526,854 A * 6/1996 Unger 141/351

D379,095 S * 5/1997 Sparks D15/85
6,651,449 B2 * 11/2003 Heims et al. 62/98
D511,534 S * 11/2005 Ertz et al. D15/89
D514,139 S * 1/2006 Ertz et al. D15/89
D544,287 S * 6/2007 Joss et al. D7/306
D568,913 S * 5/2008 Suh et al. D15/89
D569,399 S * 5/2008 Crookshanks et al. D15/89
D582,443 S * 12/2008 Kim et al. D15/89
D589,988 S * 4/2009 Martin et al. D15/89
D615,566 S * 5/2010 Curtis et al. D15/89
D672,376 S * 12/2012 Ringemann et al. D15/89
D697,537 S * 1/2014 Seo et al. D15/89

* cited by examiner

Primary Examiner — Mitchell Siegel

(74) *Attorney, Agent, or Firm* — Cantor Colburn LLP

(57) **CLAIM**

We claim, the ornamental design for a refrigerator, as shown and described.

DESCRIPTION

FIG. 1 is a perspective view of a refrigerator, showing our new design;
FIG. 2 is a front elevation view thereof;
FIG. 3 is a rear elevation view thereof;
FIG. 4 is a side elevation view thereof;
FIG. 5 is a another side elevation view thereof;
FIG. 6 is a top plan view thereof;
FIG. 7 is a bottom plan view thereof; and,
FIG. 8 is an enlarged partial perspective view thereof.
The broken lines are for illustrative purposes only and form no part of the claimed design. The dot-dash broken lines encircle portions of the claimed design that are illustrated in enlargements.

1 Claim, 7 Drawing Sheets

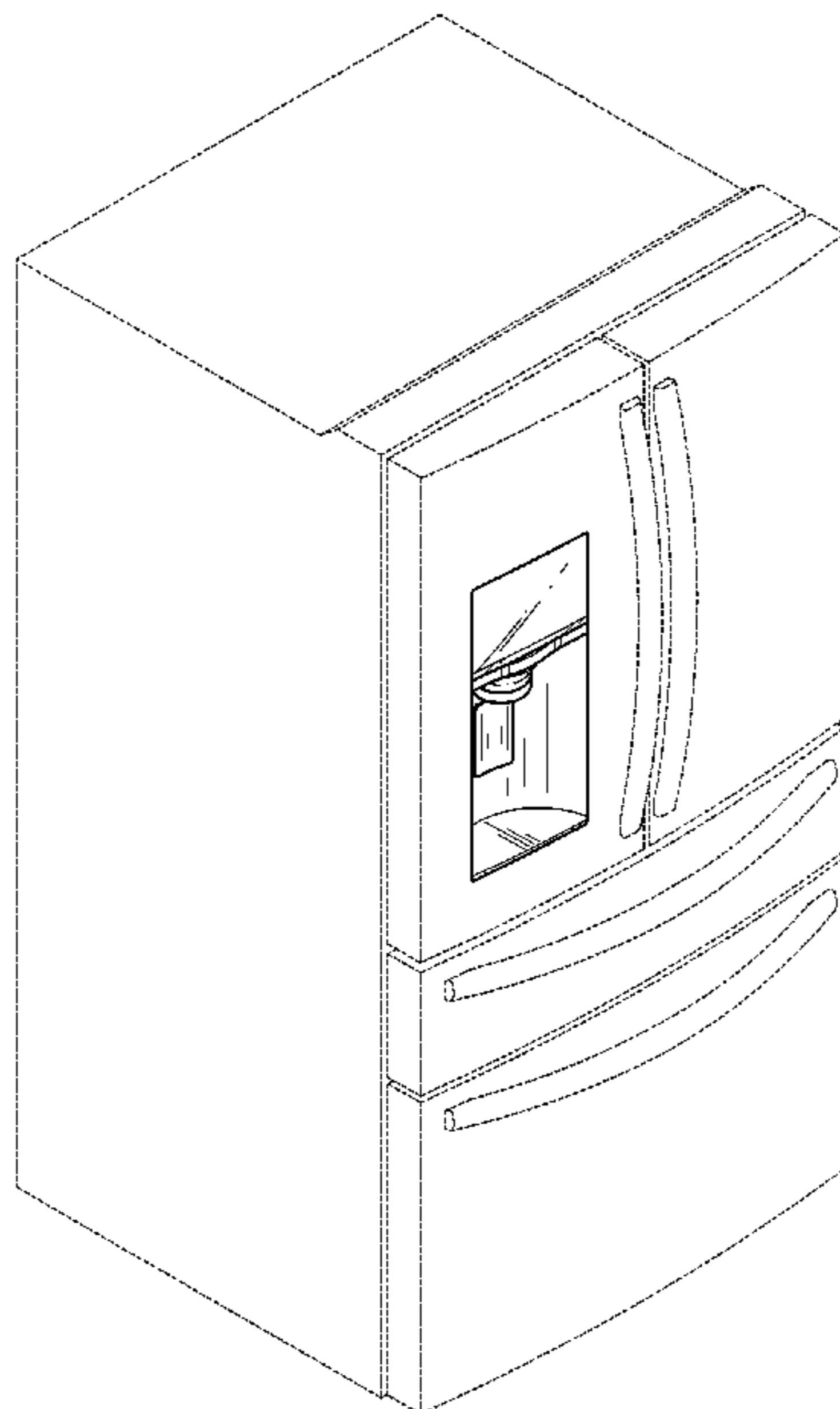

FIG. 1

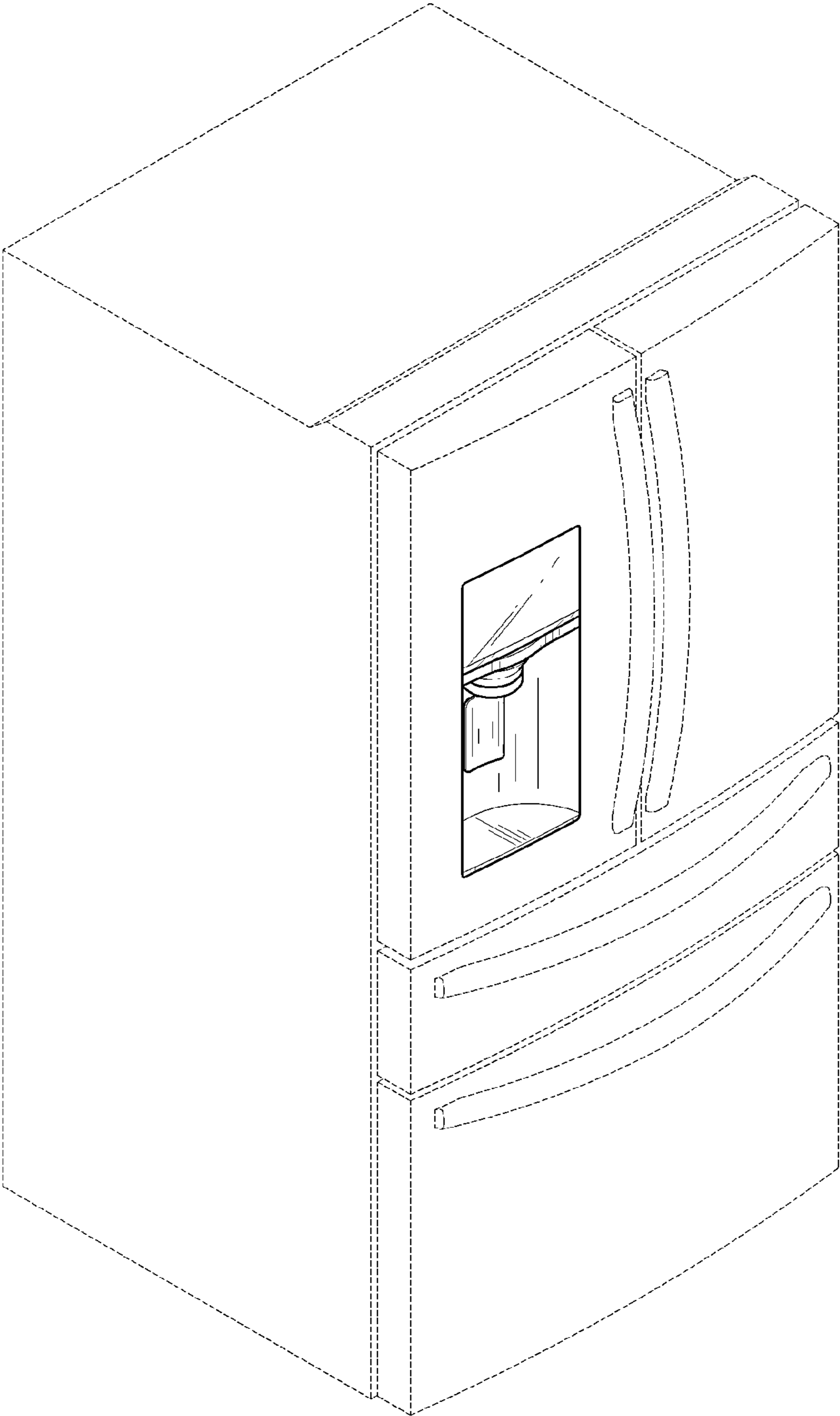

FIG. 2

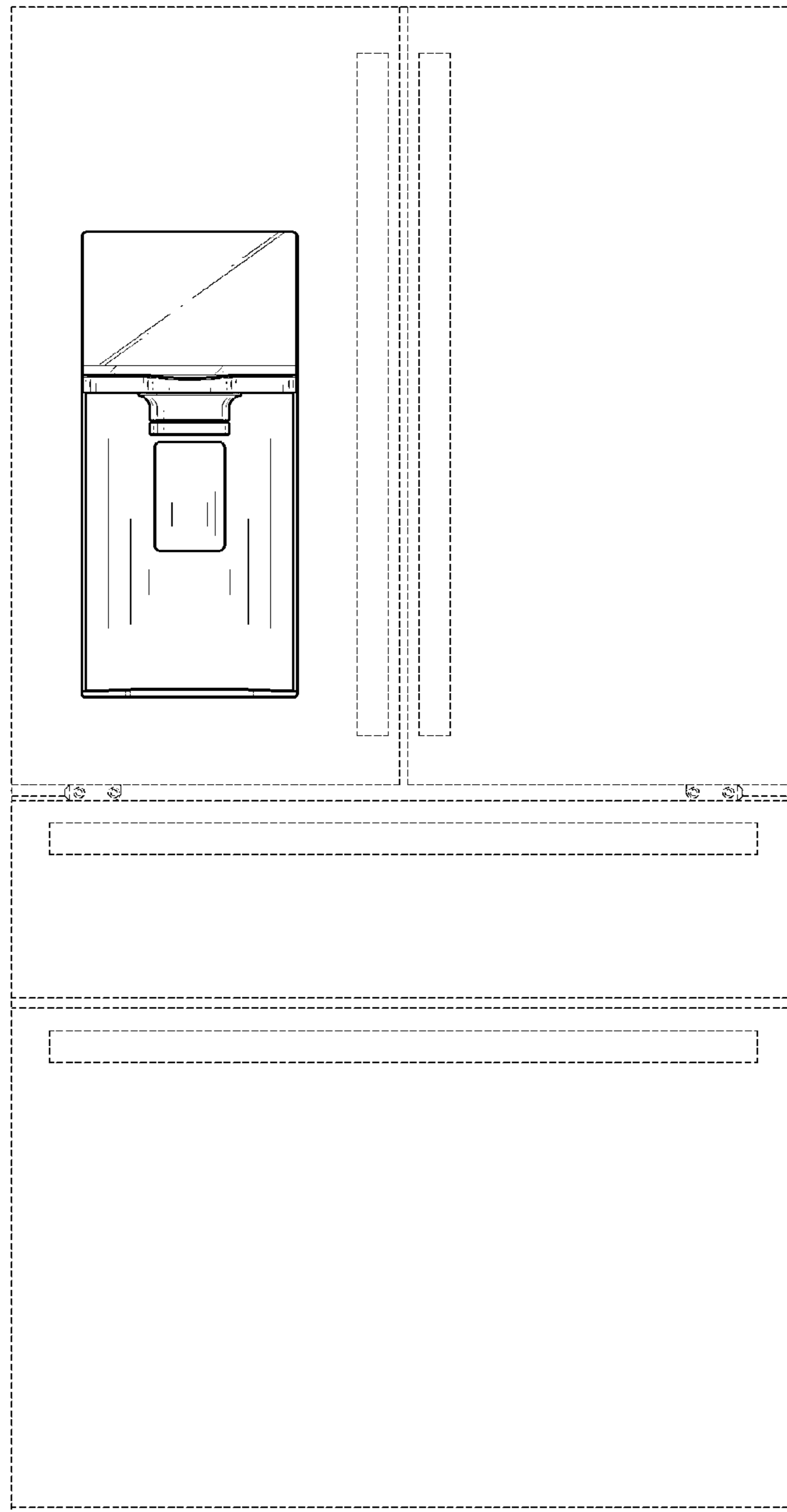

FIG. 3

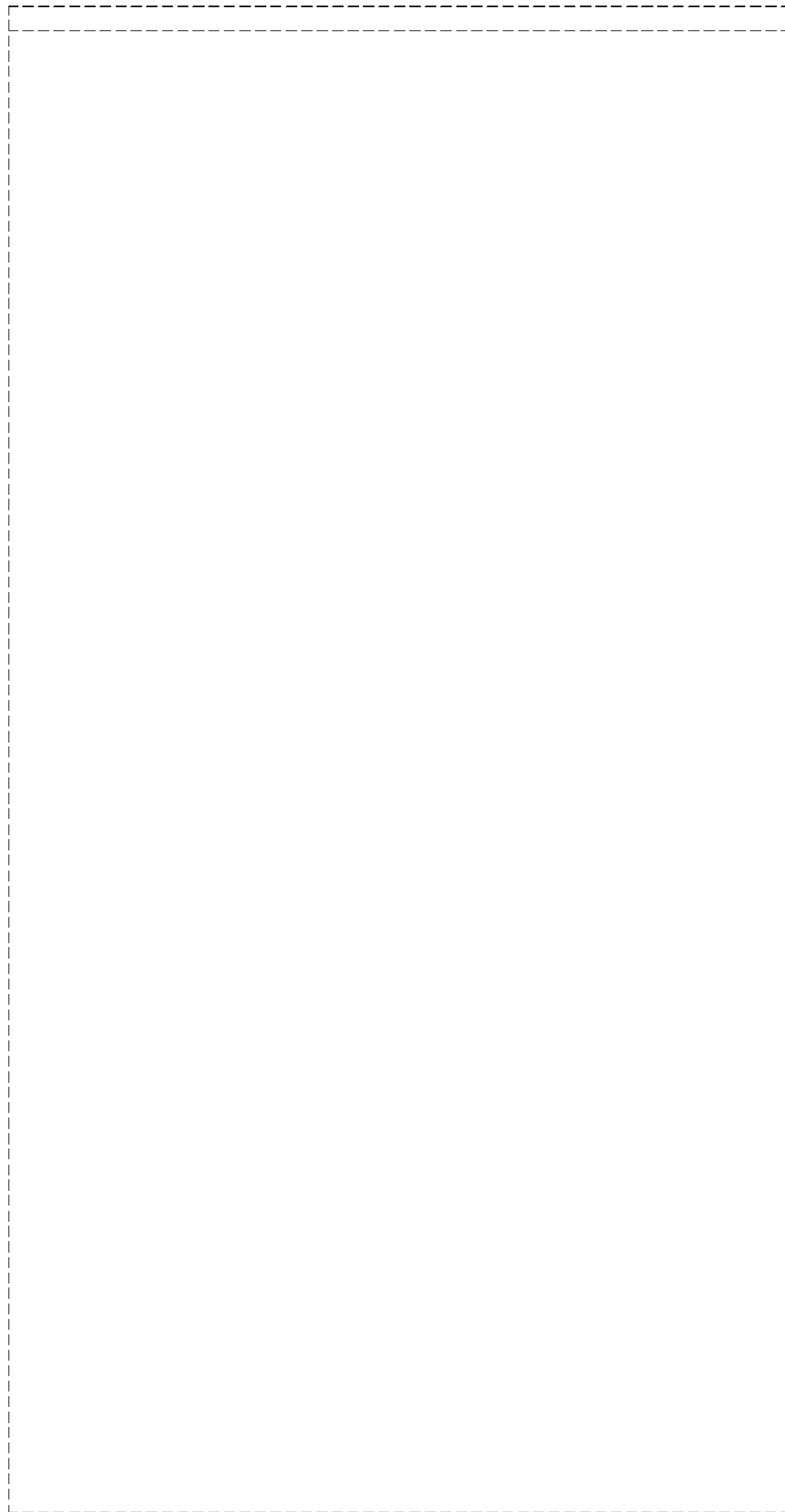

FIG. 4

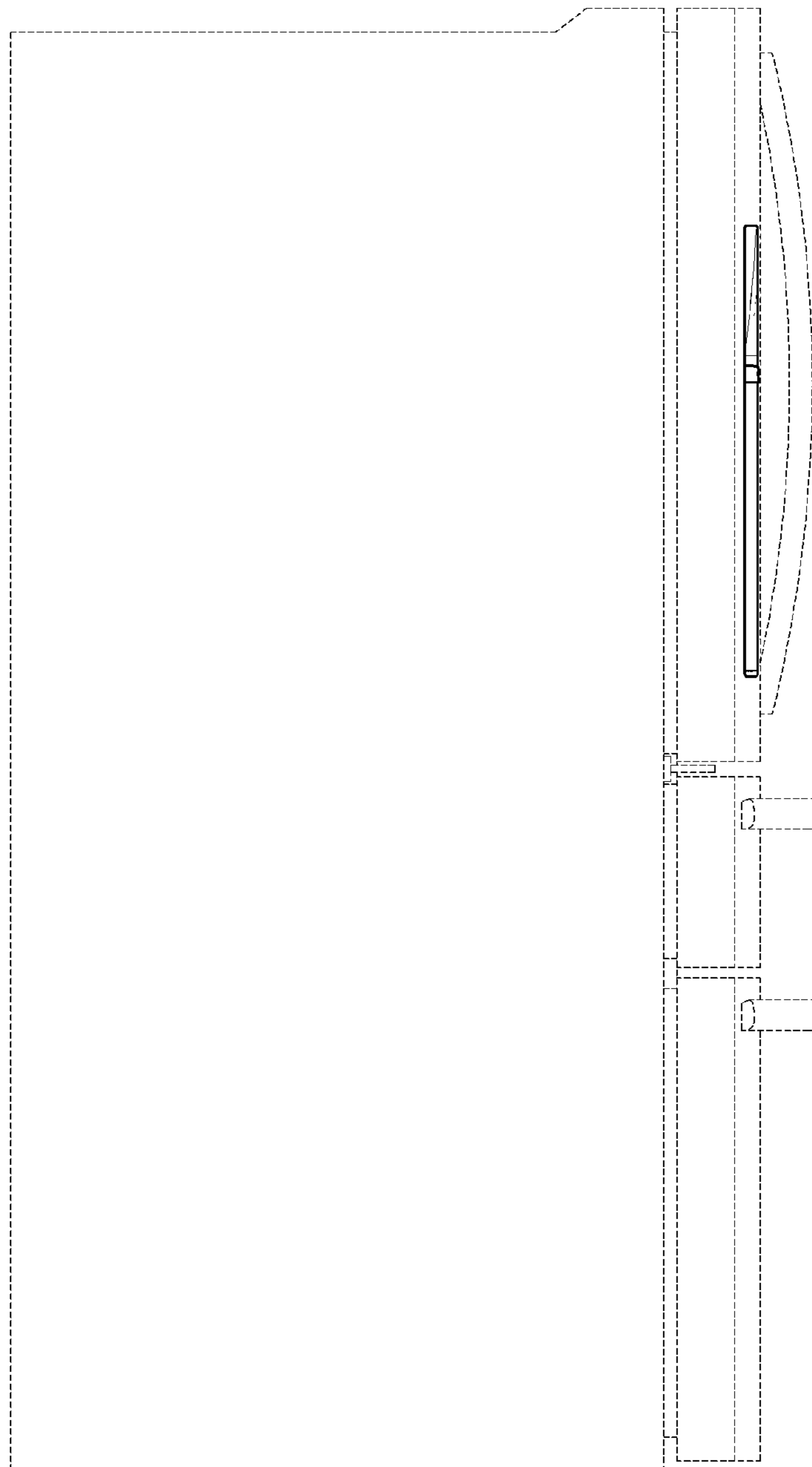

FIG. 5

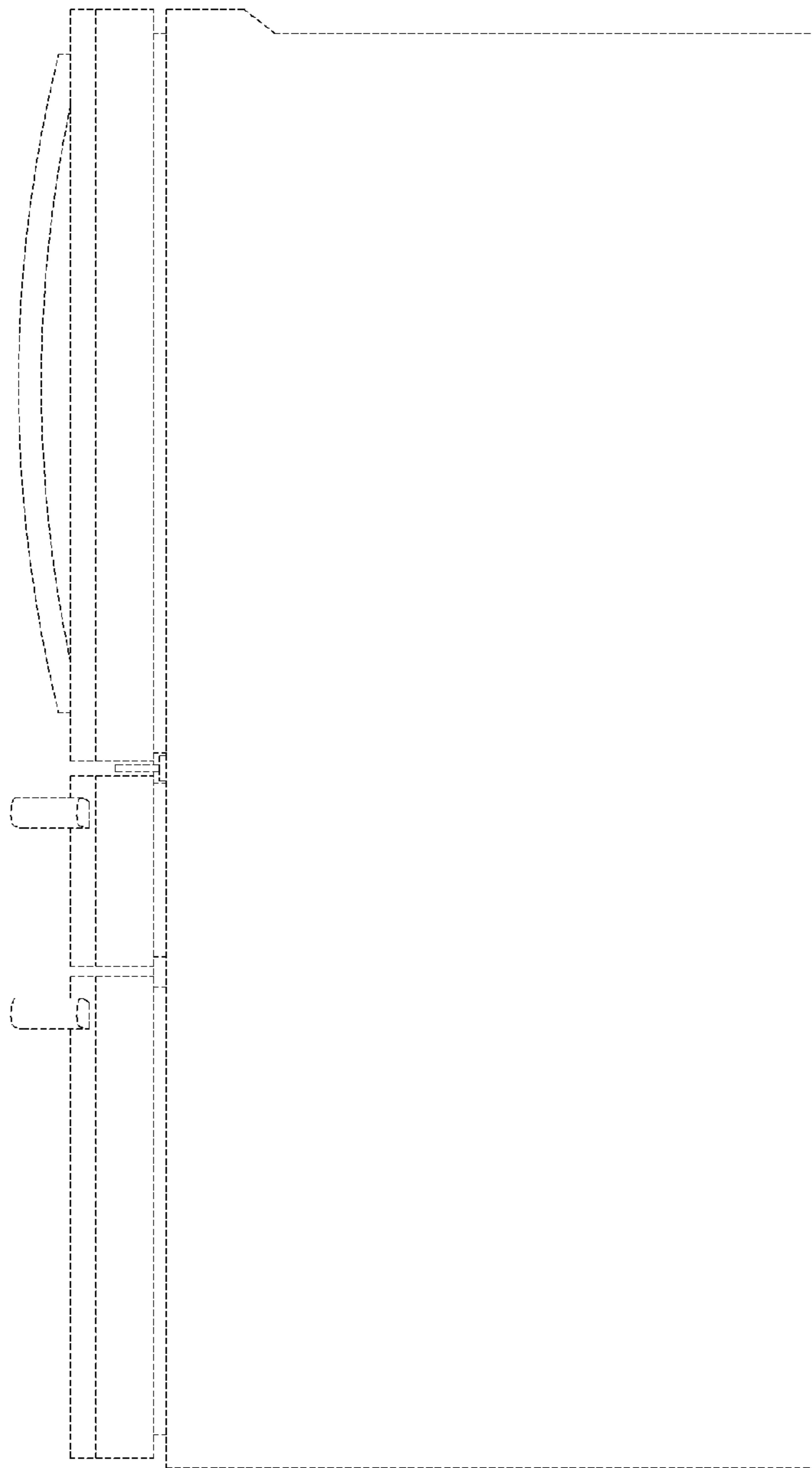

FIG. 6

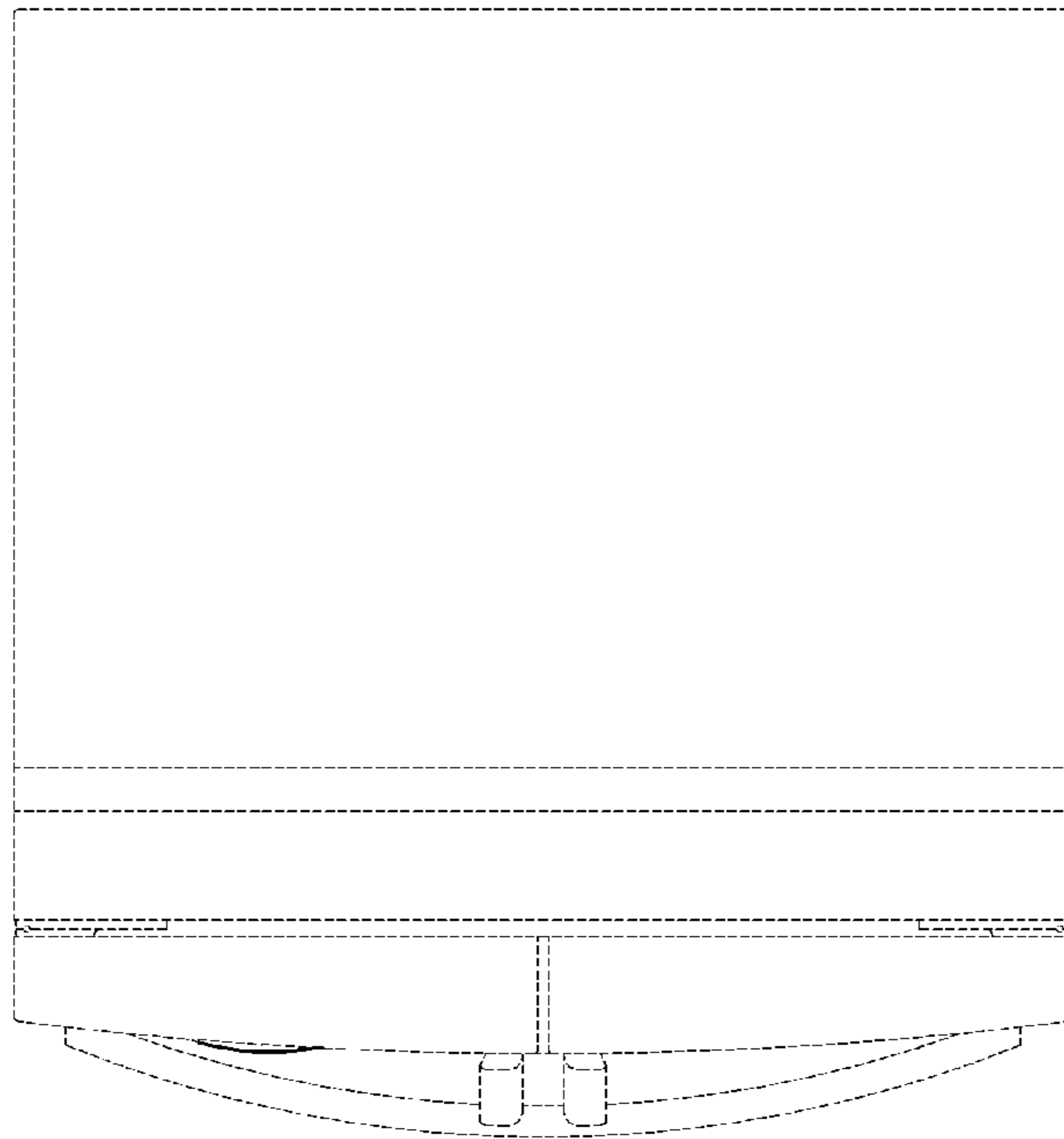

FIG. 7

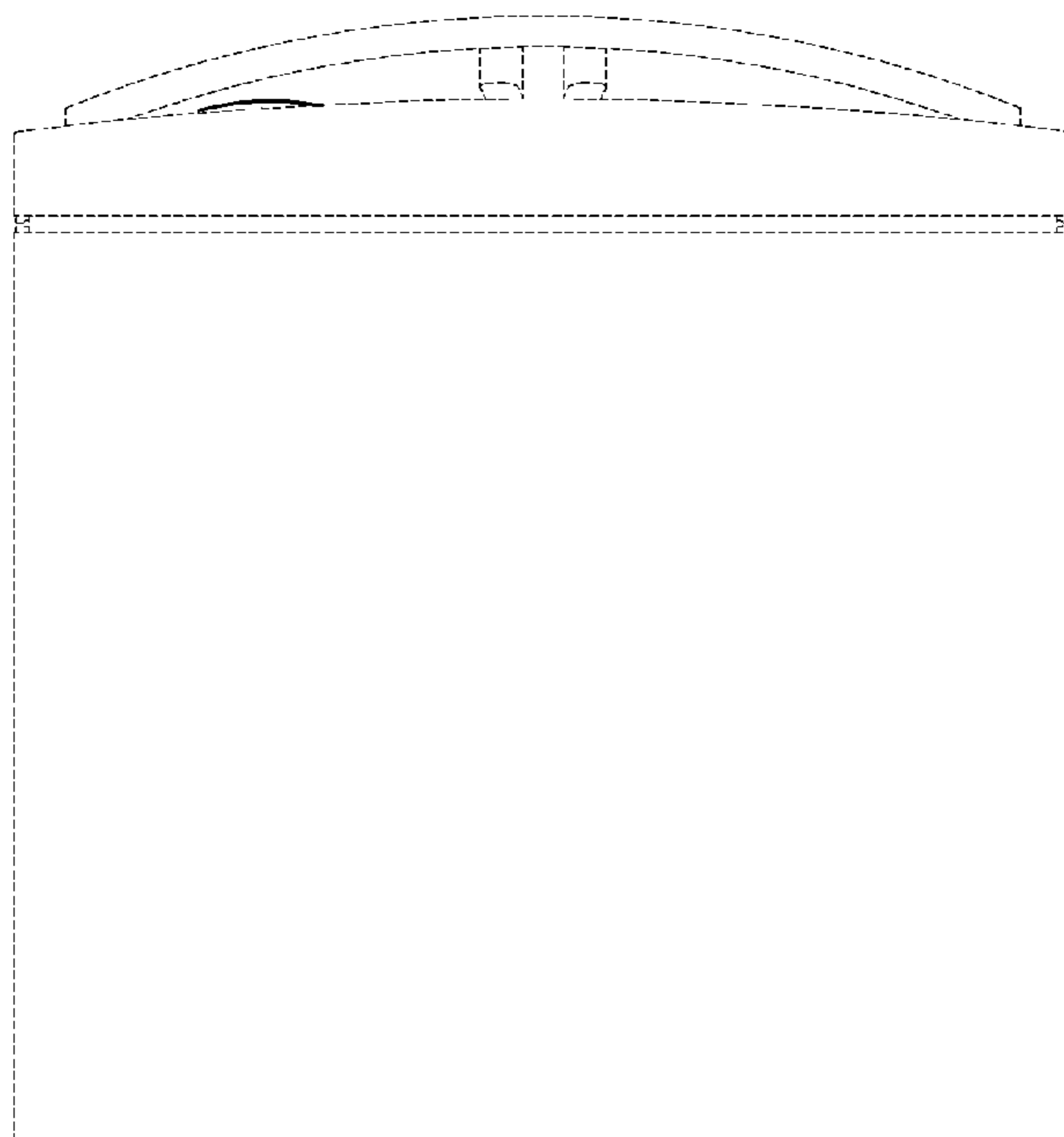

FIG. 8

