

US00D711887S

(12) **United States Design Patent**
Akana et al.

(10) **Patent No.:** **US D711,887 S**
(45) **Date of Patent:** **** Aug. 26, 2014**

(54) **CASE**

(71) Applicant: **Apple Inc.**, Cupertino, CA (US)

(72) Inventors: **Jody Akana**, San Francisco, CA (US);
Bartley K. Andre, Palo Alto, CA (US);
Jeremy Bataillou, San Francisco, CA
(US); **Daniel J. Coster**, San Francisco,
CA (US); **Daniele De Iuliis**, San
Francisco, CA (US); **M. Evans Hankey**,
San Francisco, CA (US); **Julian Hoenig**,
San Francisco, CA (US); **Richard P.**
Howarth, San Francisco, CA (US);
Jonathan P. Ive, San Francisco, CA
(US); **Duncan Robert Kerr**, San
Francisco, CA (US); **Shin Nishibori**,
Kailua, HI (US); **Matthew Dean**
Rohrbach, San Francisco, CA (US);
Peter Russell-Clarke, San Francisco,
CA (US); **Christopher J. Stringer**,
Woodside, CA (US); **Eugene Antony**
Whang, San Francisco, CA (US); **Rico**
Zörkendörfer, San Francisco, CA (US)

(73) Assignee: **Apple Inc.**, Cupertino, CA (US)

(**) Term: **14 Years**

(21) Appl. No.: **29/466,380**

(22) Filed: **Sep. 6, 2013**

Related U.S. Application Data

(63) Continuation of application No. 29/416,587, filed on
Mar. 23, 2012, now Pat. No. Des. 689,498, which is a
continuation of application No. 29/415,062, filed on
Mar. 7, 2012, now Pat. No. Des. 688,251, and a
continuation of application No. 29/415,035, filed on
Mar. 6, 2012, now abandoned.

(51) **LOC (10) Cl.** **14-02**

(52) **U.S. Cl.**
USPC **D14/440**

(58) **Field of Classification Search**

CPC A45C 2011/003; G06F 1/1628; G06F
2200/1633
USPC D14/138 G, 250, 251, 253, 240, 217,
D14/496, 440, 203.3, 203.4, 203.5, 203.8,
D14/341, 318, 345; D3/218, 215, 201, 269,
D3/273, 294, 289, 303, 327, 900;
D21/469; 220/4.02; 248/309.1;
361/679.56; 379/426, 433.11, 455;
455/575.1, 575.8; 190/100; 206/305,
206/320

See application file for complete search history.

(56) **References Cited**

U.S. PATENT DOCUMENTS

2,968,176 A	1/1961	Collings
3,442,371 A	5/1969	Deshong et al.
4,718,550 A	1/1988	Johnson
D321,855 S	11/1991	Ross, Jr.
5,066,158 A	11/1991	Huang
5,092,354 A	3/1992	Pacelli, Jr.
D331,191 S	11/1992	Ventola et al.
D340,701 S	10/1993	Takeuchi
D356,120 S	3/1995	Allen
D364,191 S	11/1995	Allen
D461,469 S	8/2002	Wang et al.
D467,429 S	12/2002	Bone et al.
D512,100 S	11/2005	Howes et al.
D517,512 S	3/2006	Peng
D518,007 S	3/2006	Peng
D518,008 S	3/2006	Peng
D538,096 S	3/2007	Bartell et al.
D538,787 S	3/2007	Tsai
D542,772 S	5/2007	Shimizu
D555,667 S	11/2007	Hussaini et al.
D556,681 S	12/2007	Kim
D557,814 S	12/2007	Glenn et al.
D574,819 S	8/2008	Andre et al.
D577,743 S	9/2008	Liu
D582,405 S	12/2008	Andre et al.
D583,360 S	12/2008	Gredler
D584,141 S	1/2009	Smith et al.
D593,540 S	6/2009	Skurdal
D594,876 S	6/2009	Hwang
D599,821 S	9/2009	Tang
D604,744 S	11/2009	Tseng et al.
D606,096 S	12/2009	Bui
D606,751 S	12/2009	Andre et al.

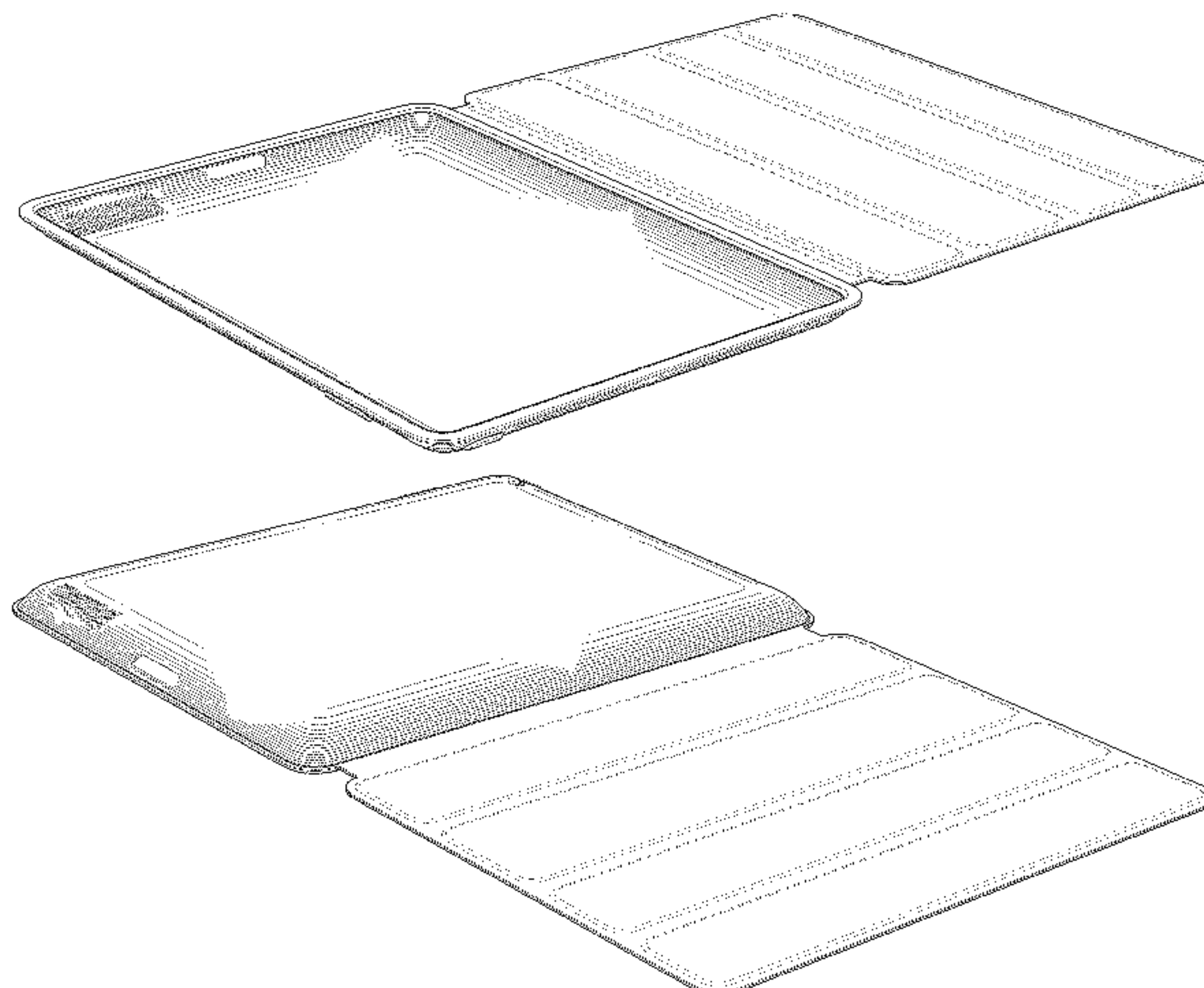

D608,794	S	1/2010	Xiao et al.	
D609,718	S	2/2010	Change et al.	
D616,416	S	5/2010	Lin	
D616,464	S	5/2010	Park	
D619,361	S	7/2010	Andre et al.	
D622,258	S	8/2010	Joseph	
D622,716	S	8/2010	Andre et al.	
D627,777	S	11/2010	Akana et al.	
D633,388	S	3/2011	Andre et al.	
D637,814	S	5/2011	Akana et al.	
D639,296	S *	6/2011	Tseng et al.	D14/345
D641,348	S *	7/2011	Kim et al.	D14/250
D644,248	S	8/2011	Kim et al.	
D649,785	S *	12/2011	Akana et al.	D3/303
D652,829	S *	1/2012	Kim et al.	D14/250
D656,495	S	3/2012	Andre et al.	
D656,929	S	4/2012	Hsiung	
D657,354	S *	4/2012	Kim	D14/250
D658,186	S	4/2012	Akana et al.	
D658,880	S *	5/2012	Akana et al.	D3/303
D662,503	S	6/2012	Akana et al.	
D663,304	S *	7/2012	Akana et al.	D14/440
D663,724	S	7/2012	Lee et al.	
D664,564	S	7/2012	Gillett et al.	
D669,059	S	10/2012	Huang	
D670,499	S *	11/2012	Akana et al.	D3/303
D670,692	S	11/2012	Andre et al.	
D671,114	S	11/2012	Akana et al.	
D671,948	S *	12/2012	Akana et al.	D14/440
D672,781	S *	12/2012	Lu	D14/440
D674,799	S *	1/2013	Kim	D14/440
D674,800	S *	1/2013	Kim	D14/440
D678,260	S	3/2013	Bau	
D679,279	S *	4/2013	Yang et al.	D14/440
D679,715	S *	4/2013	Akana et al.	D14/440
D681,641	S *	5/2013	Van Den Nieuwenhuizen et al.	D14/440
D682,836	S *	5/2013	Akana et al.	D14/440
D682,838	S *	5/2013	Akana et al.	D14/440
D685,800	S	7/2013	Canizares et al.	
D685,801	S	7/2013	Canizares et al.	
D685,802	S	7/2013	Canizares et al.	
D687,438	S *	8/2013	Lu	D14/440
D688,251	S *	8/2013	Akana et al.	D14/440
D688,868	S *	9/2013	Akana et al.	D3/303
D689,482	S *	9/2013	Akana et al.	D14/341
D689,498	S	9/2013	Akana et al.	
D690,703	S *	10/2013	Welch et al.	D14/440
D691,142	S *	10/2013	Diebel	D14/440
D691,143	S *	10/2013	Diebel	D14/440
D691,145	S *	10/2013	Nam-Su	D14/440
D691,611	S *	10/2013	Kirzinger	D14/440
D692,433	S *	10/2013	Akana et al.	D14/440
D692,434	S *	10/2013	Kim	D14/440
D694,741	S *	12/2013	Kim	D14/250
D696,253	S *	12/2013	Akana et al.	D14/345
D696,256	S *	12/2013	Piedra et al.	D14/440
D696,669	S *	12/2013	Akana et al.	D14/440
D696,693	S *	12/2013	Kim et al.	D14/496
2009/0107858	A1	4/2009	Huang	
2009/0194209	A1	8/2009	De Filippis et al.	
2010/0289390	A1	11/2010	Kenney	
2010/0300909	A1	12/2010	Hung	
2011/0164365	A1	7/2011	McClure et al.	
2012/0194448	A1	8/2012	Rothkopf	
2013/0020216	A1 *	1/2013	Chiou	206/320
2013/0048520	A1 *	2/2013	Garrett et al.	206/320
2013/0233762	A1 *	9/2013	Balaji et al.	206/736
2013/0277271	A1 *	10/2013	Toulotte	206/752

FOREIGN PATENT DOCUMENTS

EM	001266266-0001	3/2011
EM	001266282-0001	3/2011
EM	001266290-0001	3/2011
GB	4020173	6/2011
JP	D1429341	12/2011
TW	D154071	6/2013

OTHER PUBLICATIONS

Incase, "Introducing the Convertible Magazine Jacket for iPad," goincase.com, accessed at <http://goincase.com/blog/2010/11/23/introducing-the-convertible-magazine-jacket-for-ipad/>, posted Nov. 23, 2010, 7 pages.

Case-Parts, "Original Targus Folding Geunione Leather Case for Apple iPad with Built-in Holder," <http://www.case-parts.com/details/Original-Targus-Folding-Genuine-Leather-Case-for-Apple-iPad-with-Built-in-Holder-IPAD-570/photos.htm>, 3 pages.

"Review: AViiQ Smart Case for iPad 2", which was published on YouTube at <http://www.youtube.com/watch?v=DaHjzeVWEuA>, May 24, 2011, 3 pages.

"AViiQ Smart Case for iPad 2 compliments Apple's Smart Cover (Review)", which was published on YouTube at <http://www.youtube.com/watch?v=wMoZM-ZSn4g>, Aug. 31, 2011, 2 pages.

Youtube.com, "iPad 2—Best Protective Case—Smart Cover + Smart Cover Back by Simplism", (<http://www.youtube.com/watch?v=SRHhU98NAd0&feature=endscreen&NR=1>), May 15, 2011.

"The First iPad 2 Smart Cover Clones are Here," which was published on GIZMODO.com at <http://gizmodo.com/5782270/the-first-ipad-2-smart-cover-clones-are-here>, Mar. 15, 2011, 2 pages.

* cited by examiner

Primary Examiner — Deanna L Pratt

Assistant Examiner — Lilyana Bekic

(74) Attorney, Agent, or Firm — Sterne, Kessler, Goldstein & Fox P.L.L.C.

(57) CLAIM

The ornamental design for a case, as shown and described.

DESCRIPTION

FIG. 1 is a top front perspective view of a case in an open position showing our new design;

FIG. 2 is a bottom rear perspective view thereof;

FIG. 3 is a front view thereof;

FIG. 4 is a rear view thereof;

FIG. 5 is a bottom view thereof;

FIG. 6 is a top view thereof;

FIG. 7 is a left side view thereof showing the case in an open position;

FIG. 8 is a right side view thereof showing the case in an open position;

FIG. 9 is a front view thereof showing the case in a closed position;

FIG. 10 is an enlarged bottom view of the case in an open position shown in two parts for ease of illustration; and,

FIG. 11 is an enlarged top view thereof shown in two parts for ease of illustration.

The broken lines in the Figures show portions of the case which form no part of the claimed design.

The dot-dot-dash lines in FIGS. 10 and 11 show the location at which the two parts of each figure are divided for ease of illustration, and form no part of the claimed design.

The shade lines in the Figures show contour and not surface ornamentation.

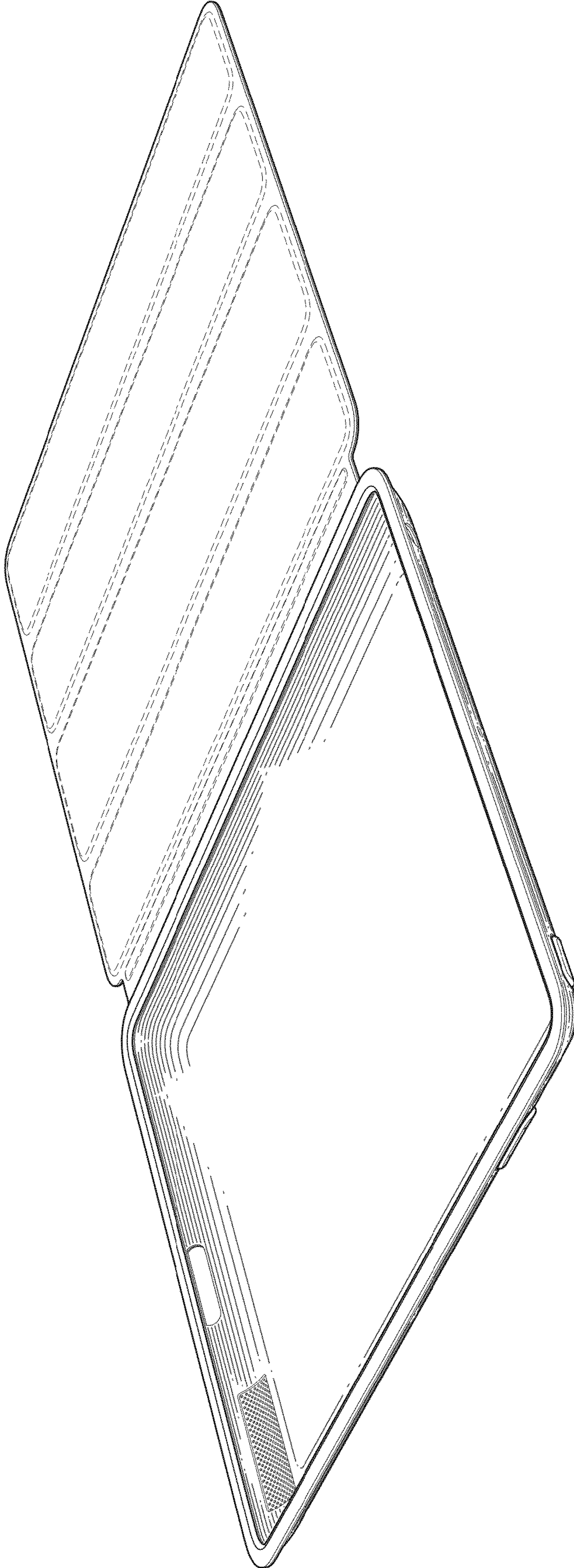

FIG. 1

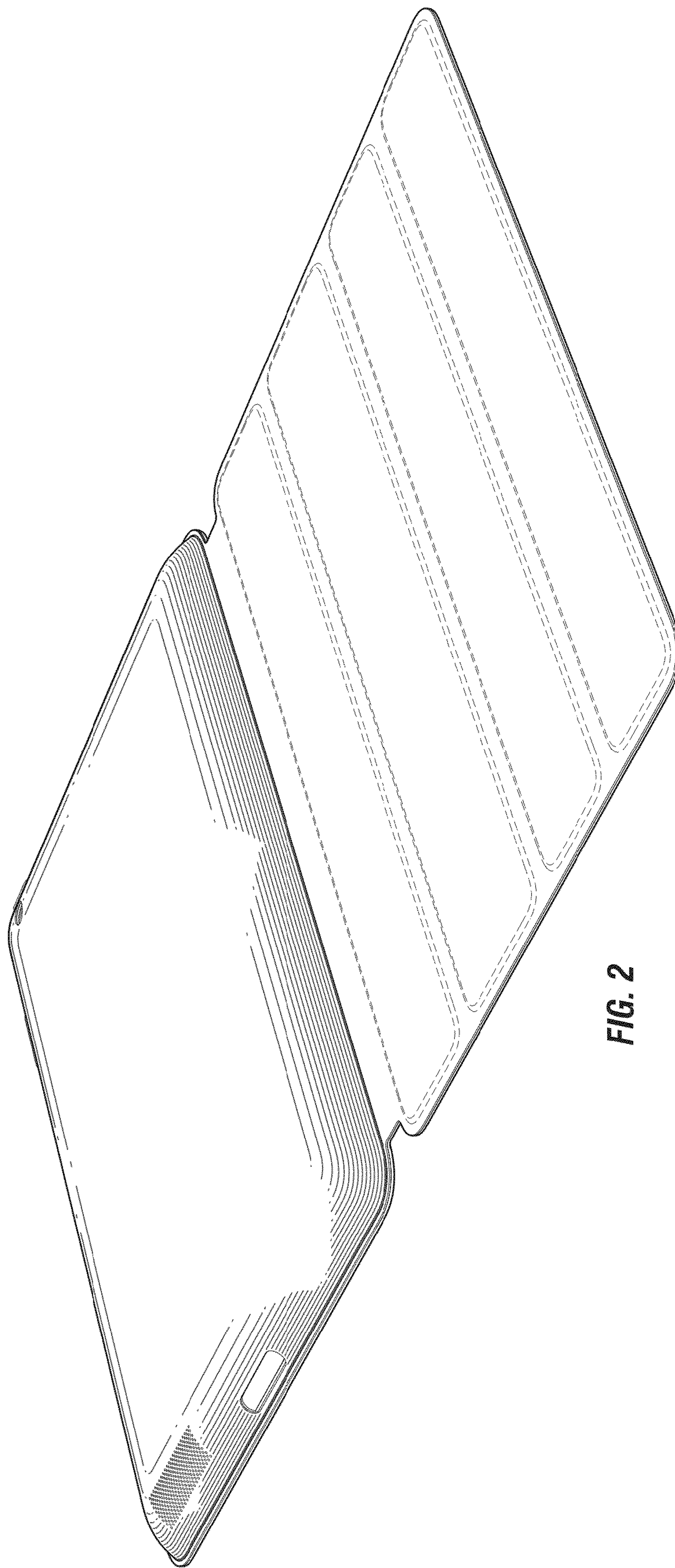

FIG. 2

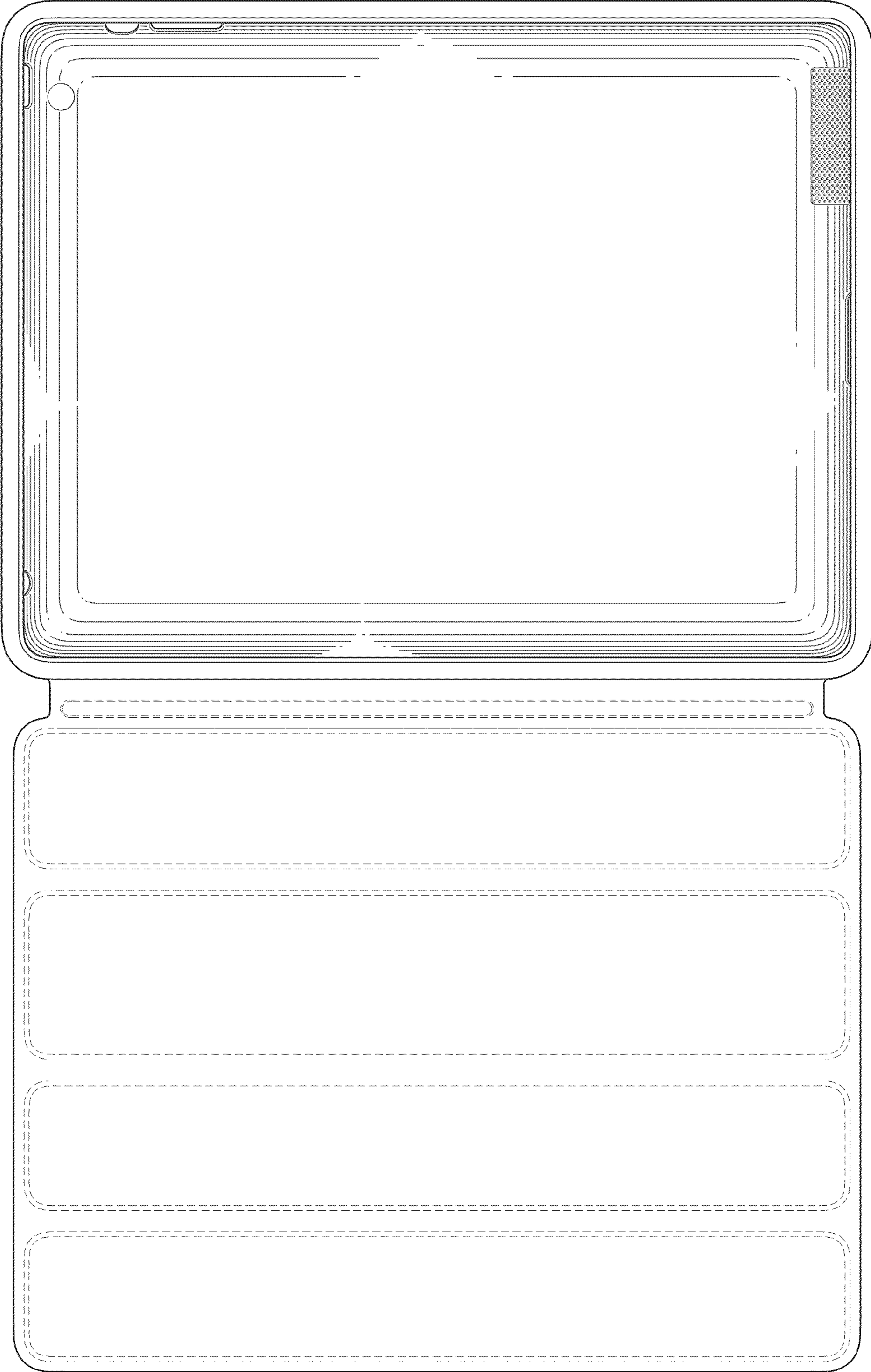

FIG. 3

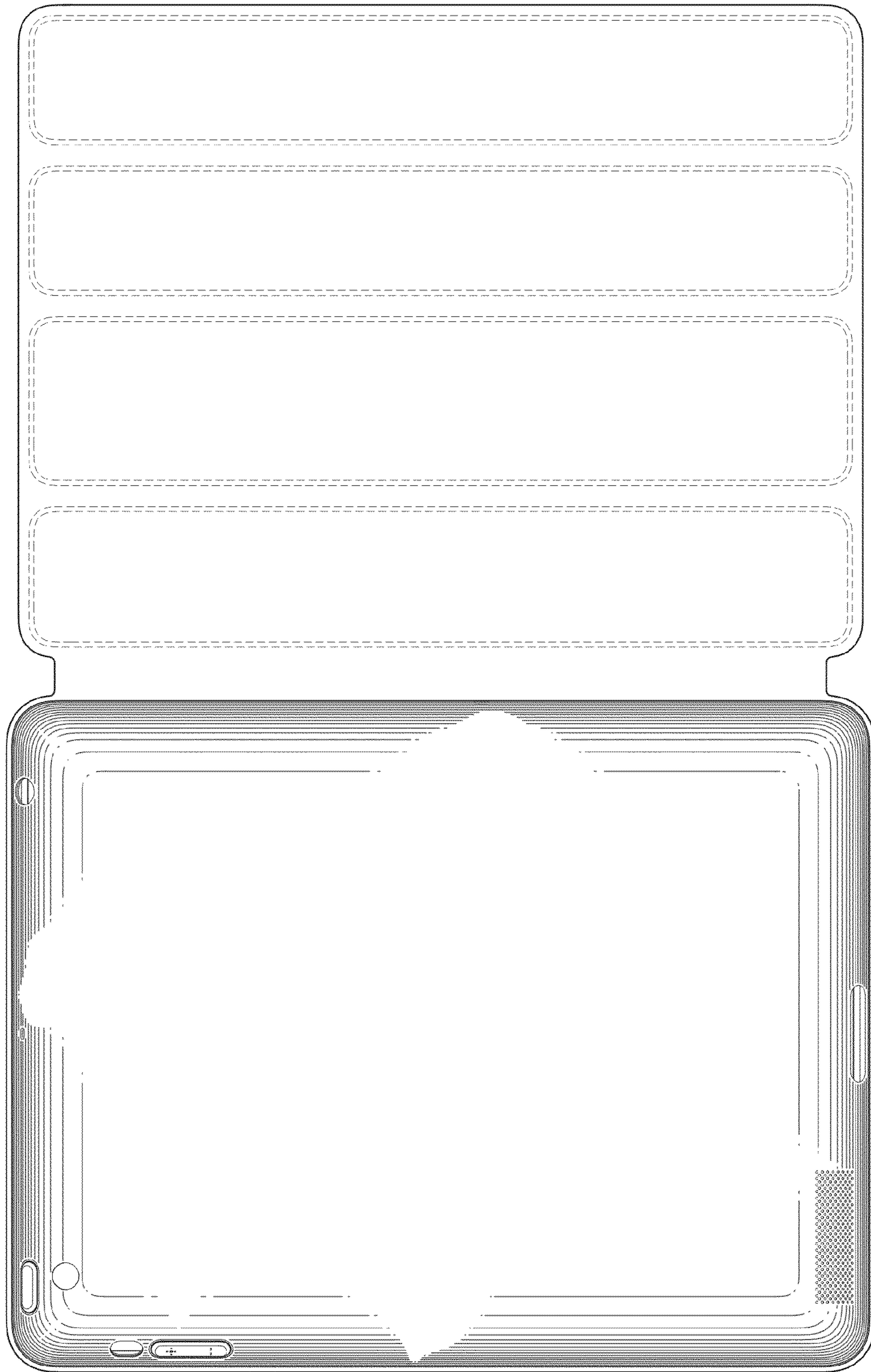

FIG. 4

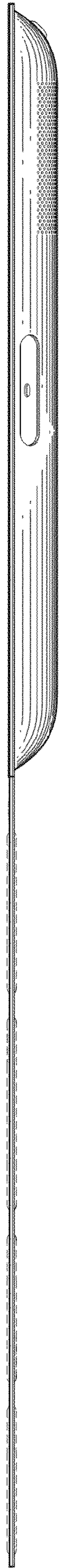

FIG. 5

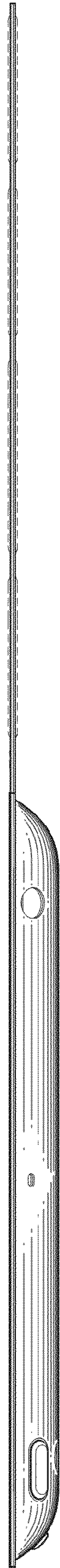

FIG. 6

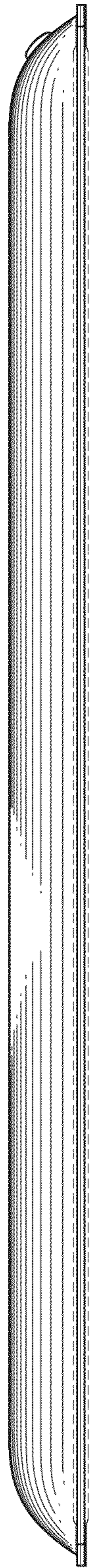

FIG. 7

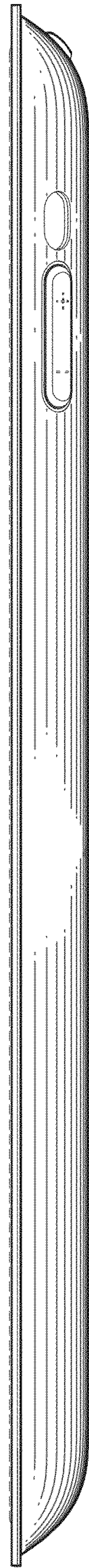

FIG. 8

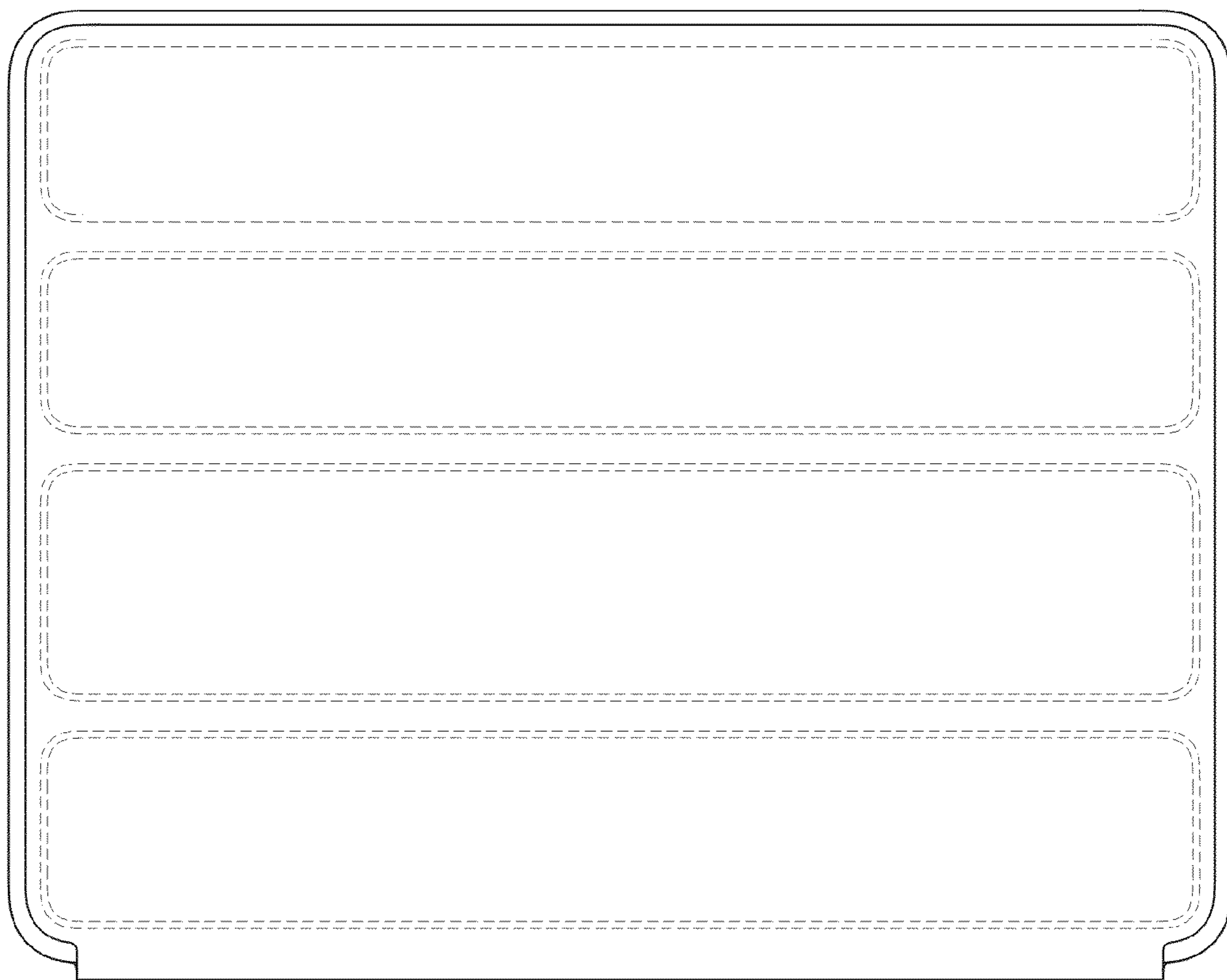

FIG. 9

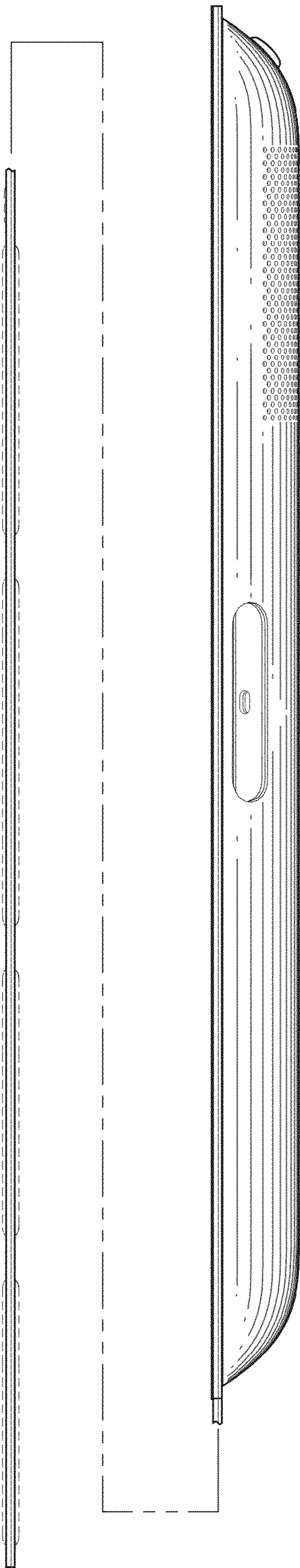

FIG. 10

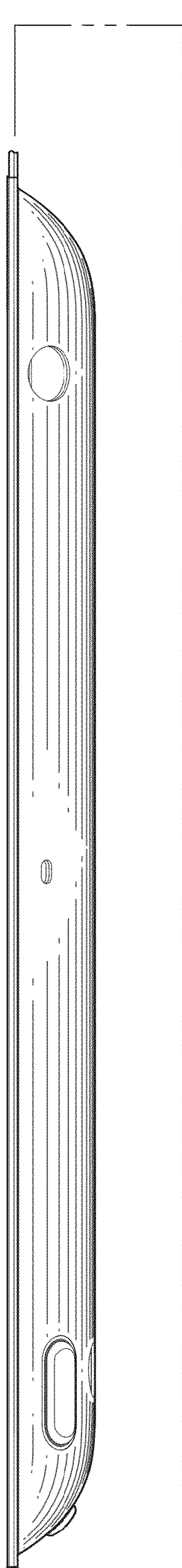
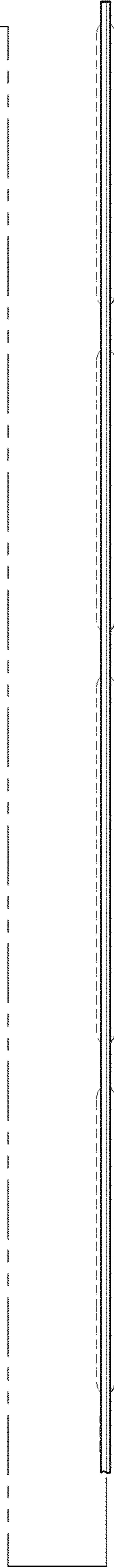

FIG. 11



UNITED STATES PATENT AND TRADEMARK OFFICE
CERTIFICATE OF CORRECTION

PATENT NO. : D711,887 S
APPLICATION NO. : 29/466380
DATED : August 26, 2014
INVENTOR(S) : Jody Akana et al.

Page 1 of 3

It is certified that error appears in the above-identified patent and that said Letters Patent is hereby corrected as shown below:

In the Drawings

Please replace figures 3 and 9 with the attached replacement figures.

Signed and Sealed this
Thirtieth Day of December, 2014



Michelle K. Lee
Deputy Director of the United States Patent and Trademark Office

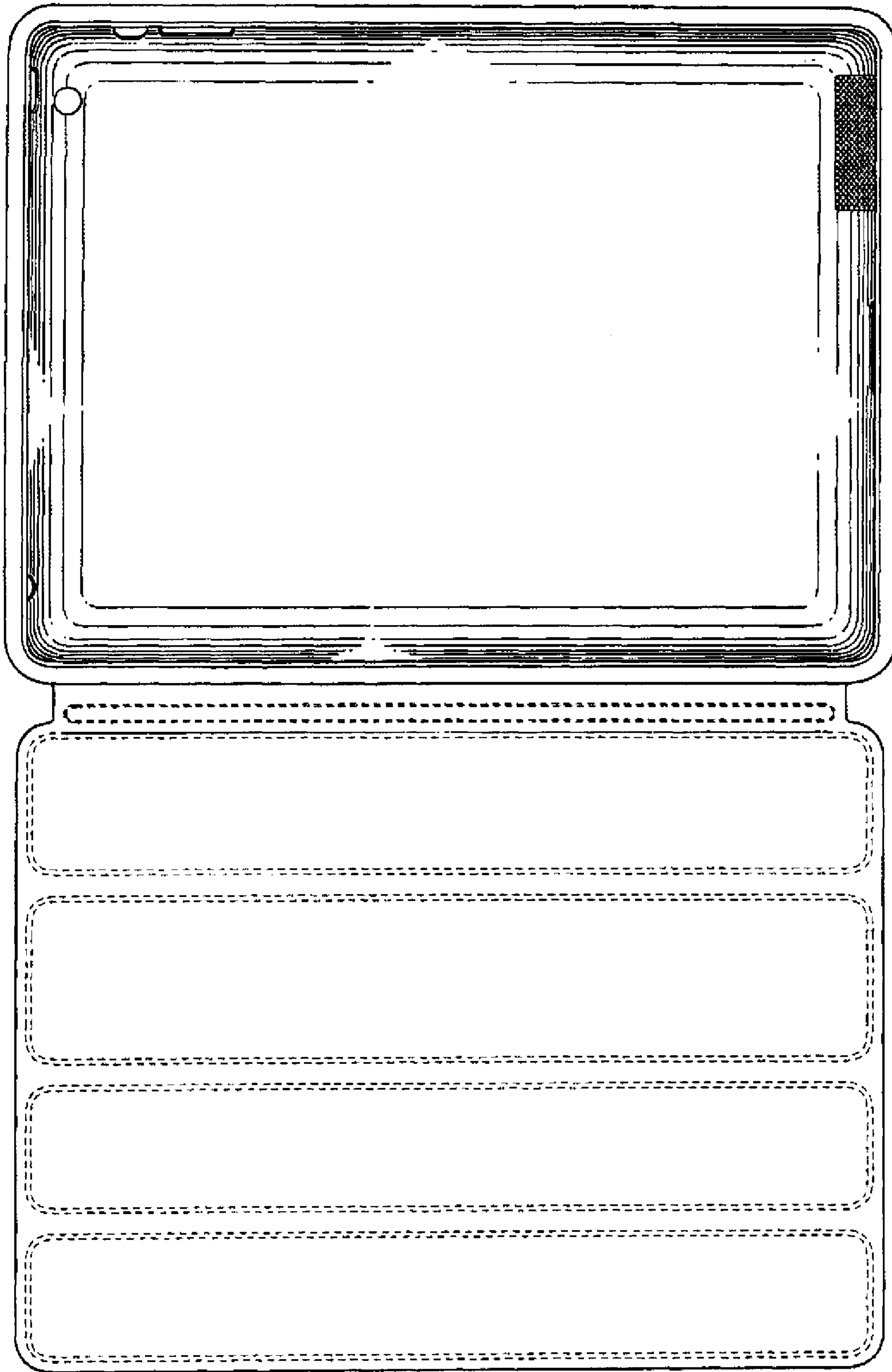

FIG. 3

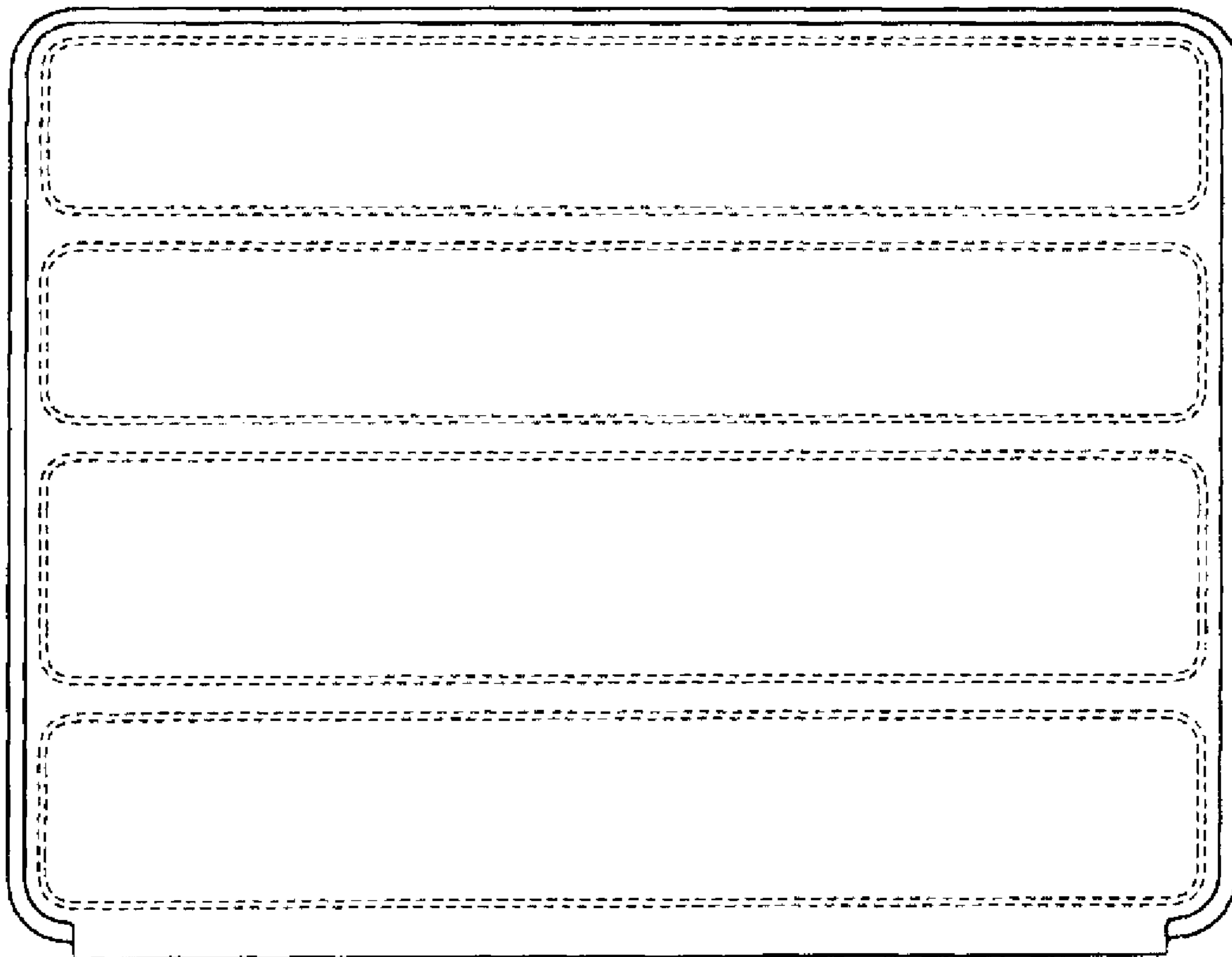

FIG. 9