



US00D711861S

(12) **United States Design Patent**
Mei

(10) **Patent No.:** **US D711,861 S**

(45) **Date of Patent:** **** Aug. 26, 2014**

(54) **PROTECTIVE COVER**

(75) Inventor: **Chia-Yun Mei**, Taoyuan County (TW)

(73) Assignee: **HTC Corporation**, Taoyuan County (TW)

(**) Term: **14 Years**

(21) Appl. No.: **29/422,785**

(22) Filed: **May 24, 2012**

(51) **LOC (10) Cl.** **14-03**

(52) **U.S. Cl.**
USPC **D14/250**

(58) **Field of Classification Search**

CPC H04M 1/0283; A45C 2011/002; A45C 2011/003; A45C 13/002; A45C 2013/025; G06F 1/1628

USPC D14/138 G, 250, 251, 253, 240, 217, D14/496, 440, 203.3, 203.4, 203.5, 203.8, D14/341, 318, 345; D3/218, 215, 201, 269, D3/273, 294, 289, 303, 327, 900; D21/469; 220/4.02; 248/309.1; 361/679.56; 379/426, 433.11, 455; 455/575.1, 575.8; 190/100; 206/305, 206/320

See application file for complete search history.

(56) **References Cited**

U.S. PATENT DOCUMENTS

D582,405 S *	12/2008	Andre et al.	D3/299
D652,829 S *	1/2012	Kim et al.	D14/250
D657,354 S *	4/2012	Kim	D14/250
D674,799 S *	1/2013	Kim	D14/440
D674,800 S *	1/2013	Kim	D14/440
D694,245 S *	11/2013	Sanz	D14/440
D694,523 S *	12/2013	Chiang	D3/303
D694,741 S *	12/2013	Kim	D14/250
D695,296 S *	12/2013	Hsu	D14/440
2010/0089778 A1 *	4/2010	Park	206/320

2011/0266291 A1 *	11/2011	Fan	220/669
2012/0085679 A1 *	4/2012	Kim et al.	206/736
2012/0178507 A1 *	7/2012	Lee	455/575.1
2012/0322518 A1 *	12/2012	Kim	455/575.8
2013/0264235 A1 *	10/2013	Lin	206/320

FOREIGN PATENT DOCUMENTS

KR 30-0607102 7/2011

OTHER PUBLICATIONS

“Office Action of Taiwan counterpart application”, issued on Dec. 20, 2012, p. 1-p. 4.

* cited by examiner

Primary Examiner — Deanna L Pratt

Assistant Examiner — Lilyana Bekic

(74) *Attorney, Agent, or Firm* — Jianq Chyun IP Office

(57) **CLAIM**

The ornamental design for a protective cover, as shown and described.

DESCRIPTION

FIG. 1 is a perspective view of a protective cover showing my new design;

FIG. 2 is an another perspective view thereof;

FIG. 3 is a front view thereof;

FIG. 4 is a rear view thereof;

FIG. 5 is a left side view thereof;

FIG. 6 is a right side view thereof;

FIG. 7 is a top view thereof;

FIG. 8 is a bottom view thereof;

FIG. 9 is a front view thereof, shown in an open position;

FIG. 10 is a perspective view thereof, shown in upright position of use; and,

FIG. 11 is another perspective view thereof, shown in upright position of use.

1 Claim, 9 Drawing Sheets

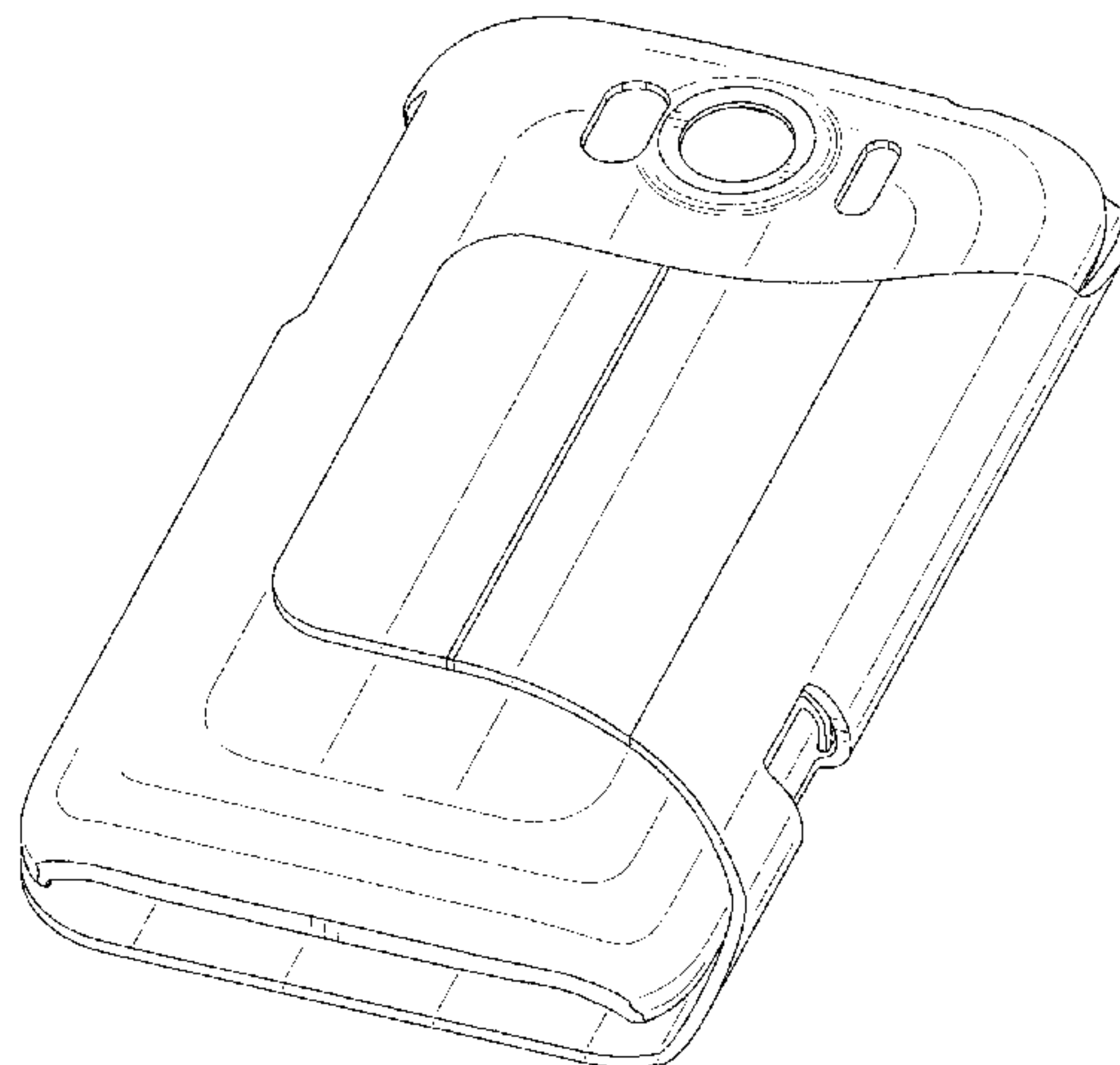
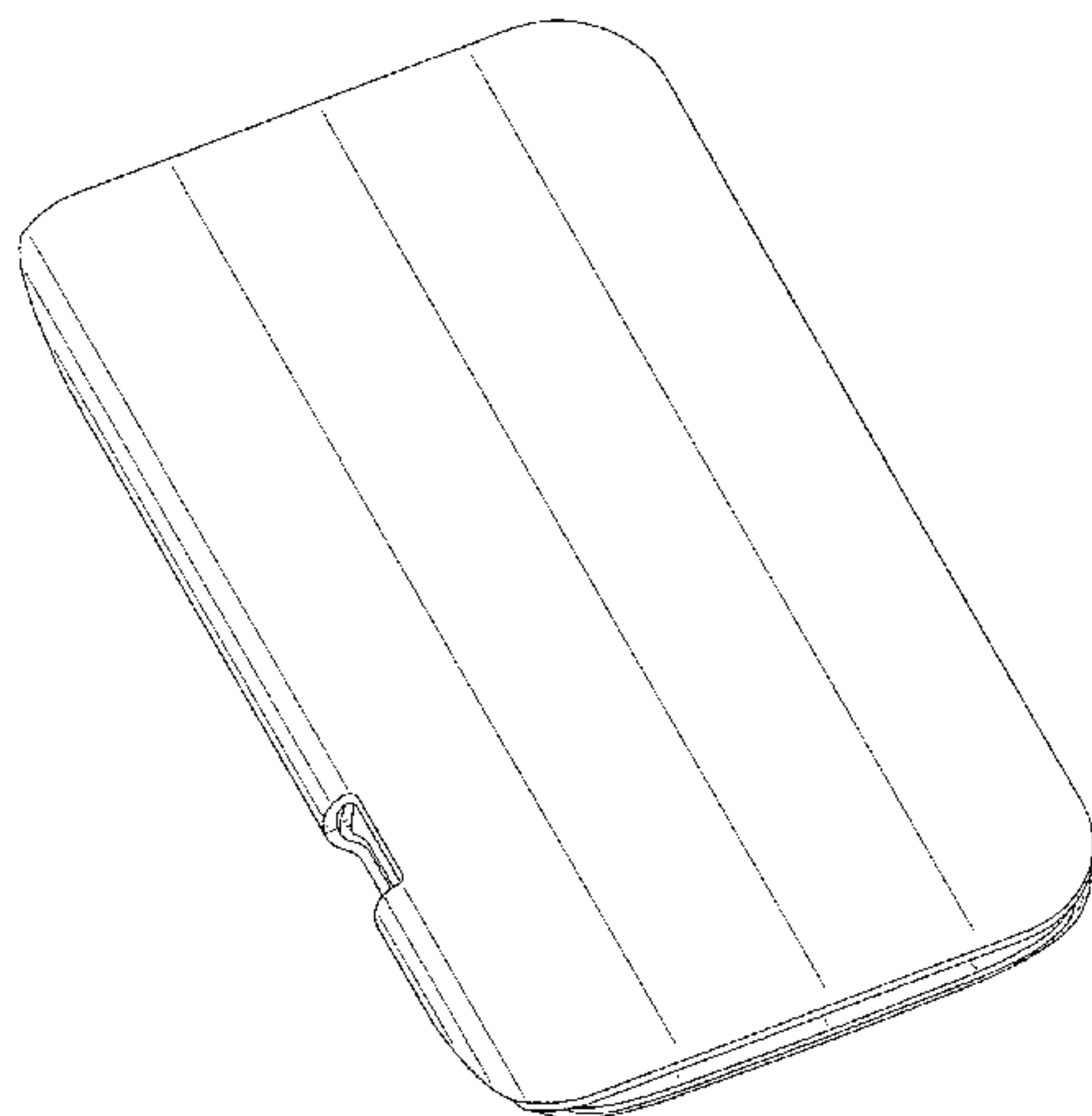

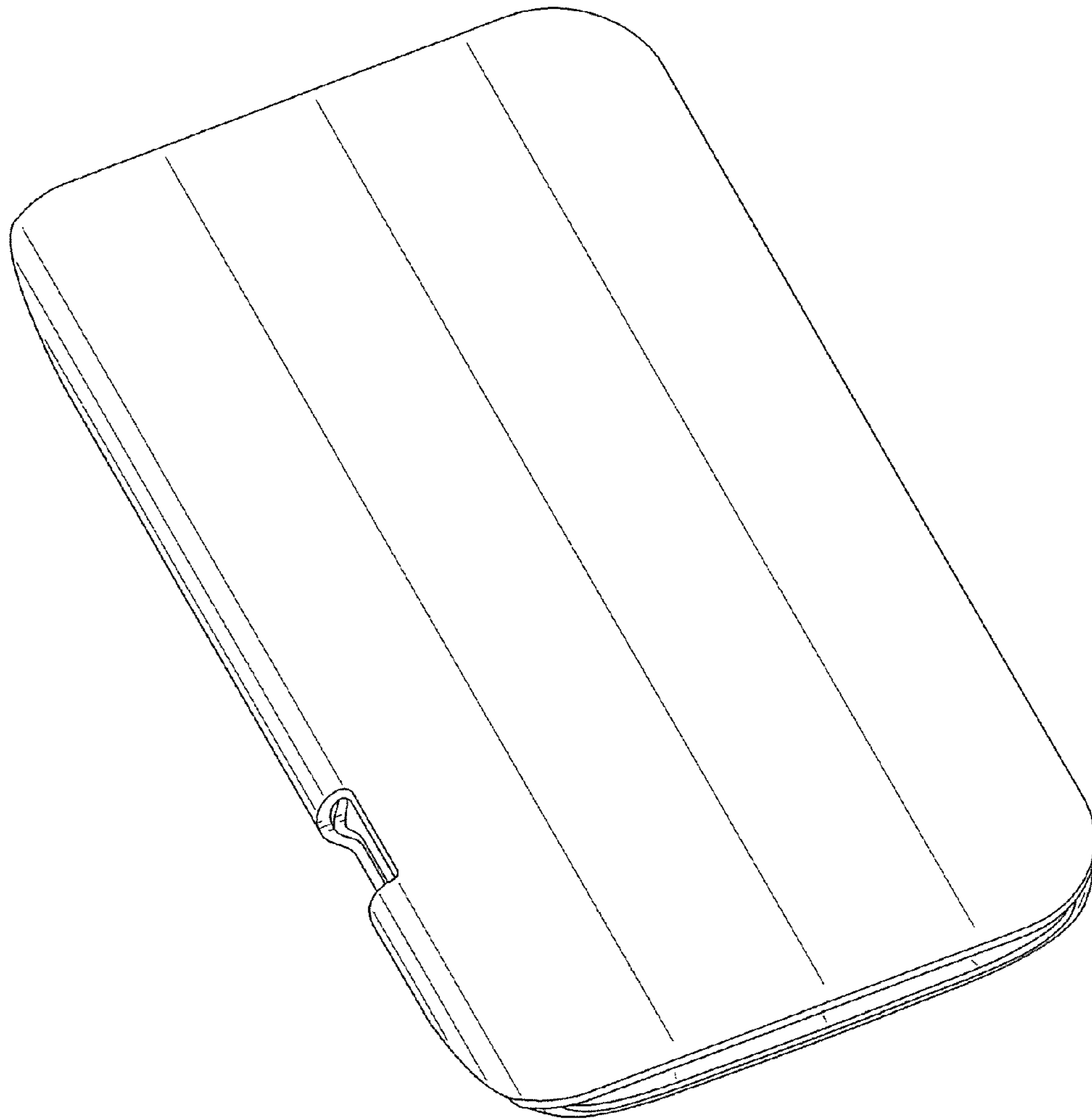

FIG. 1



FIG. 2

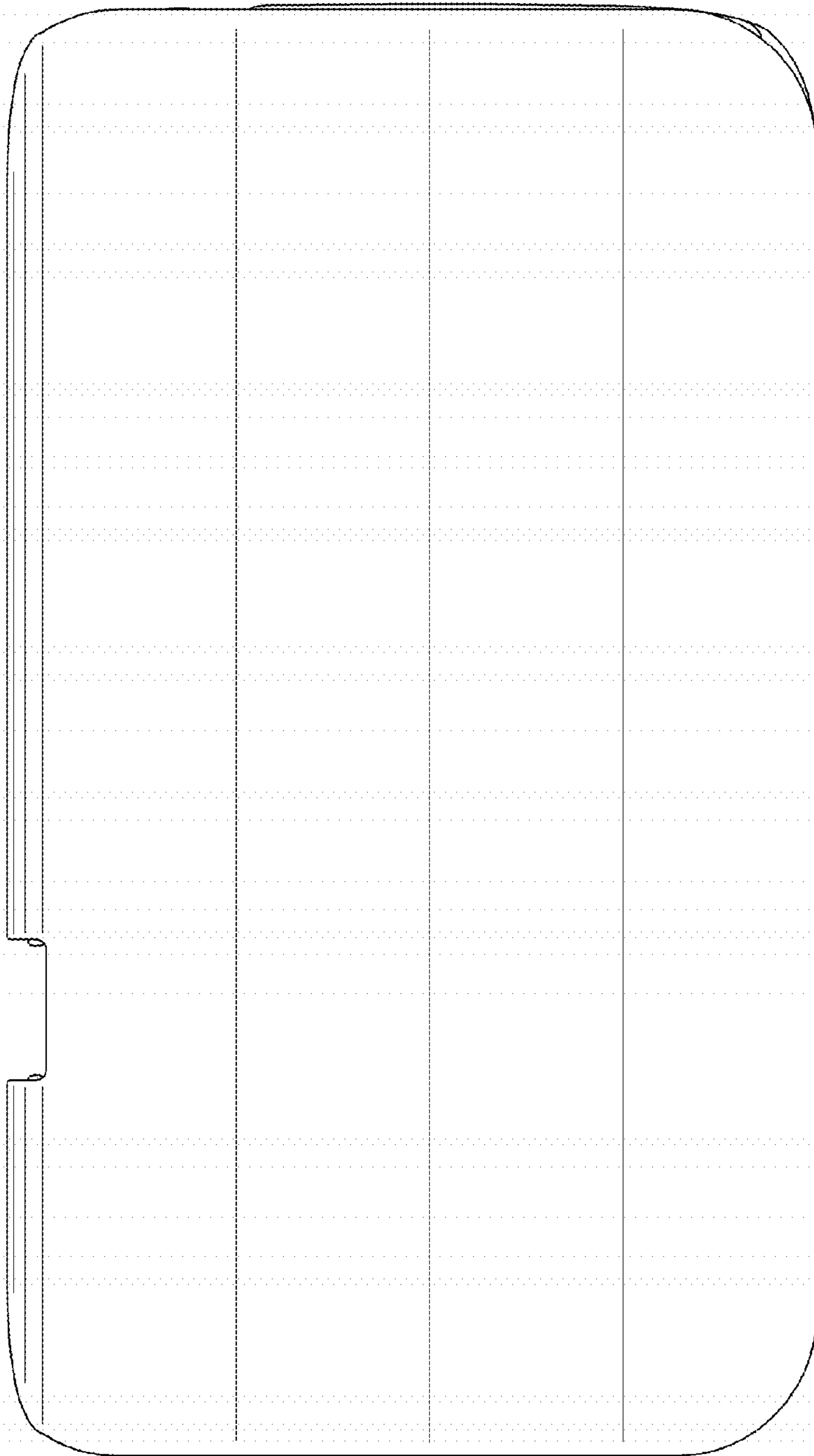

FIG. 3

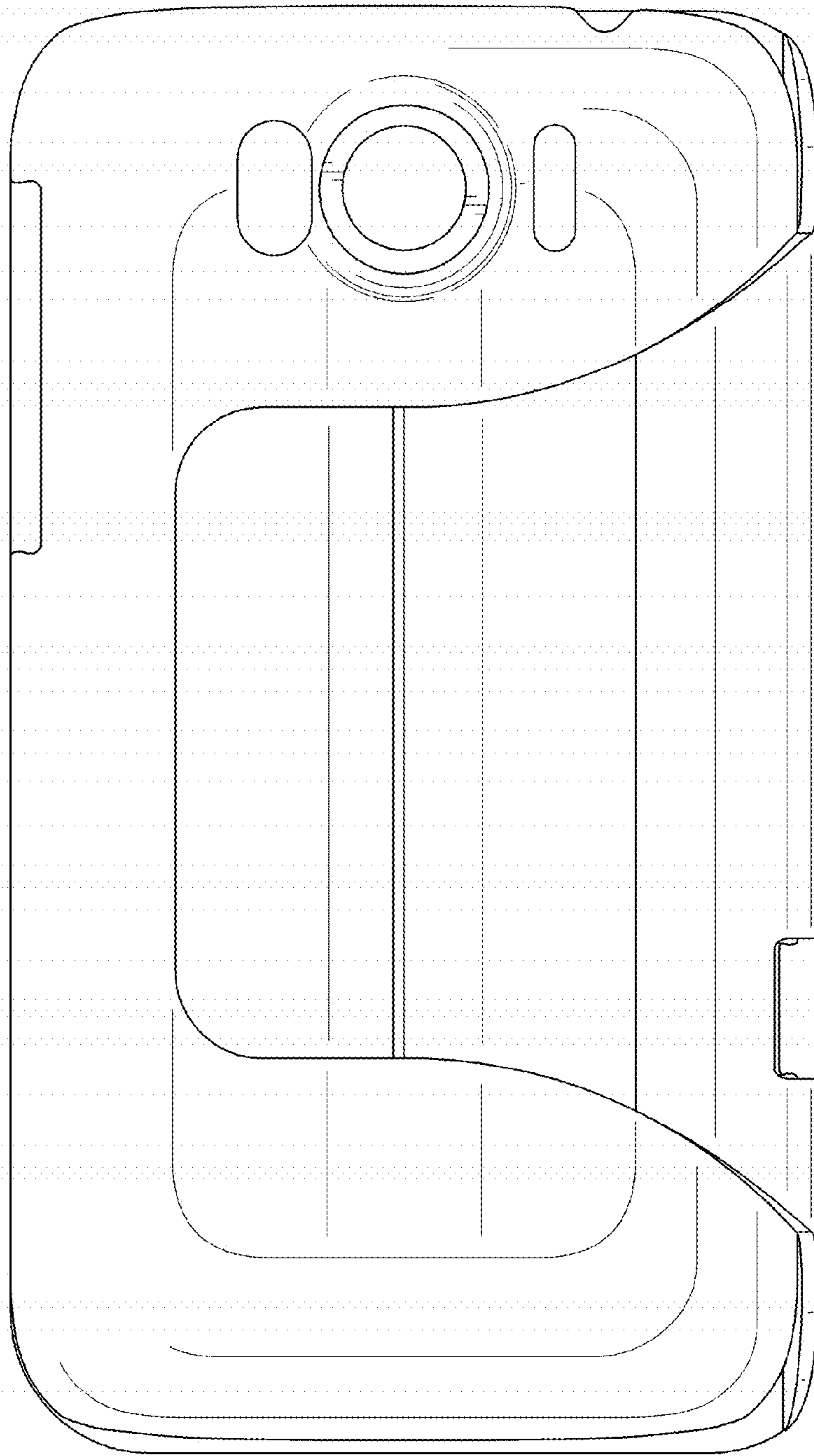

FIG. 4

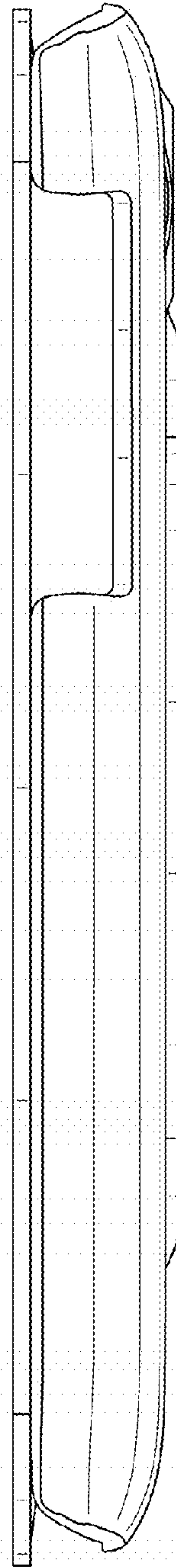
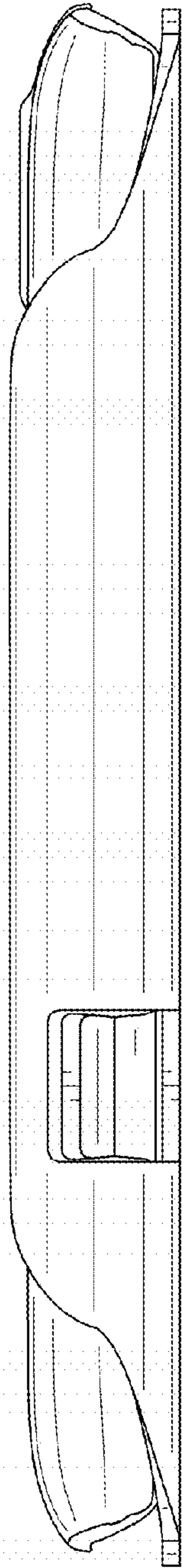

FIG. 5

FIG. 6

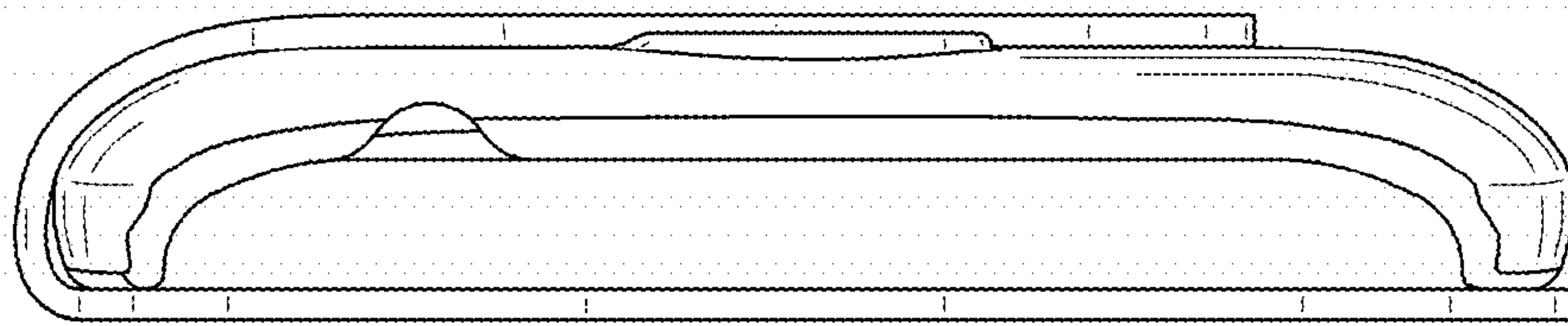

FIG. 7

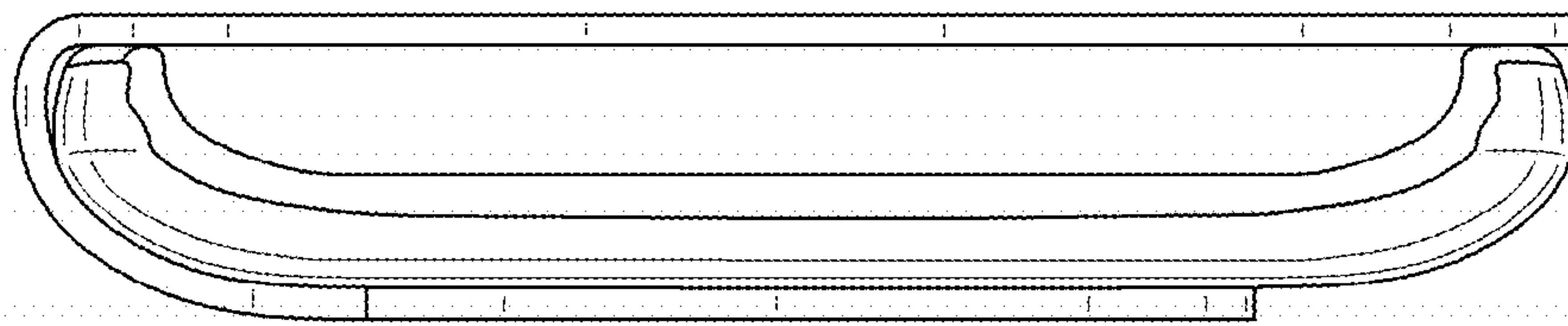

FIG. 8

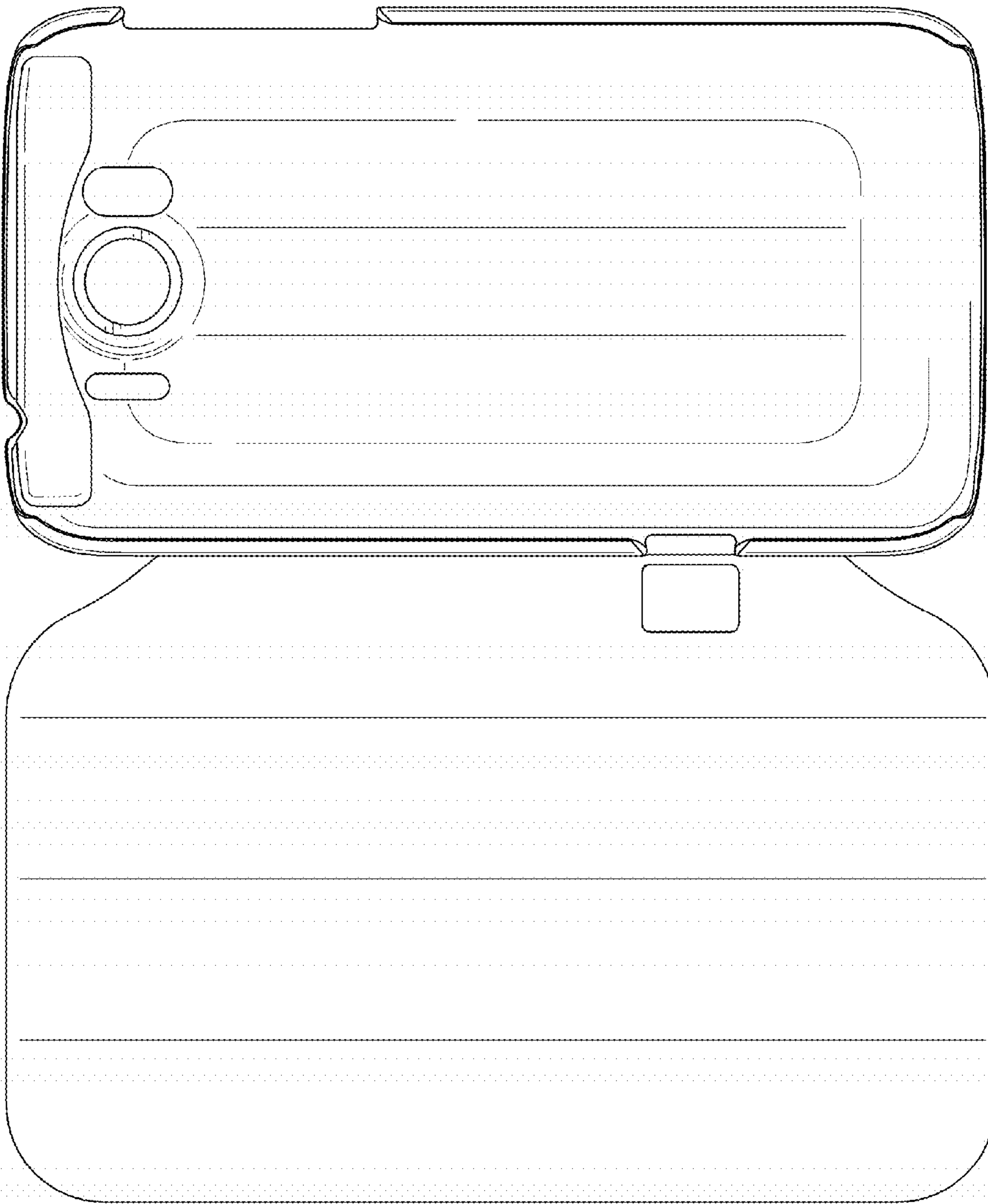

FIG. 9

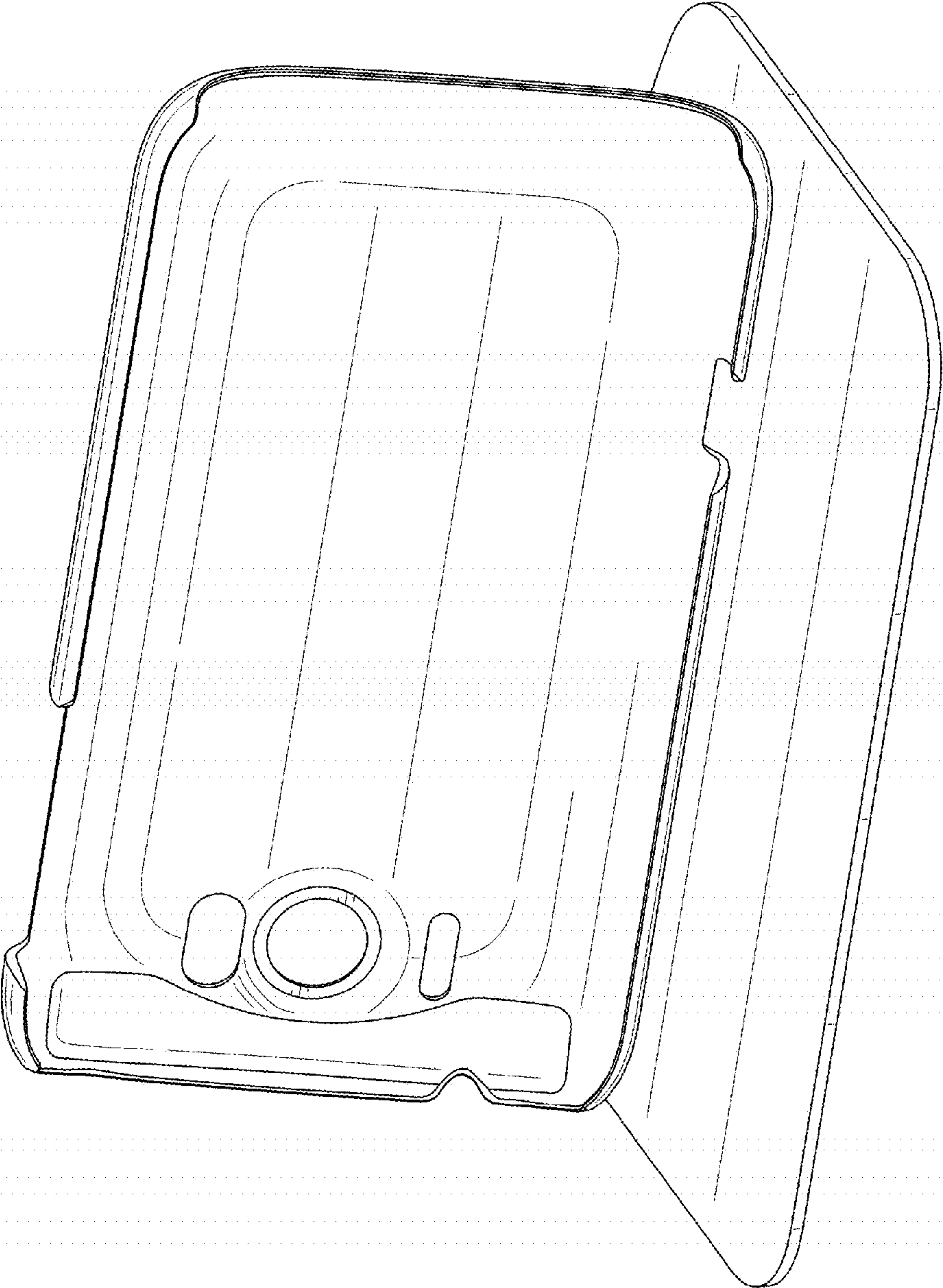

FIG. 10

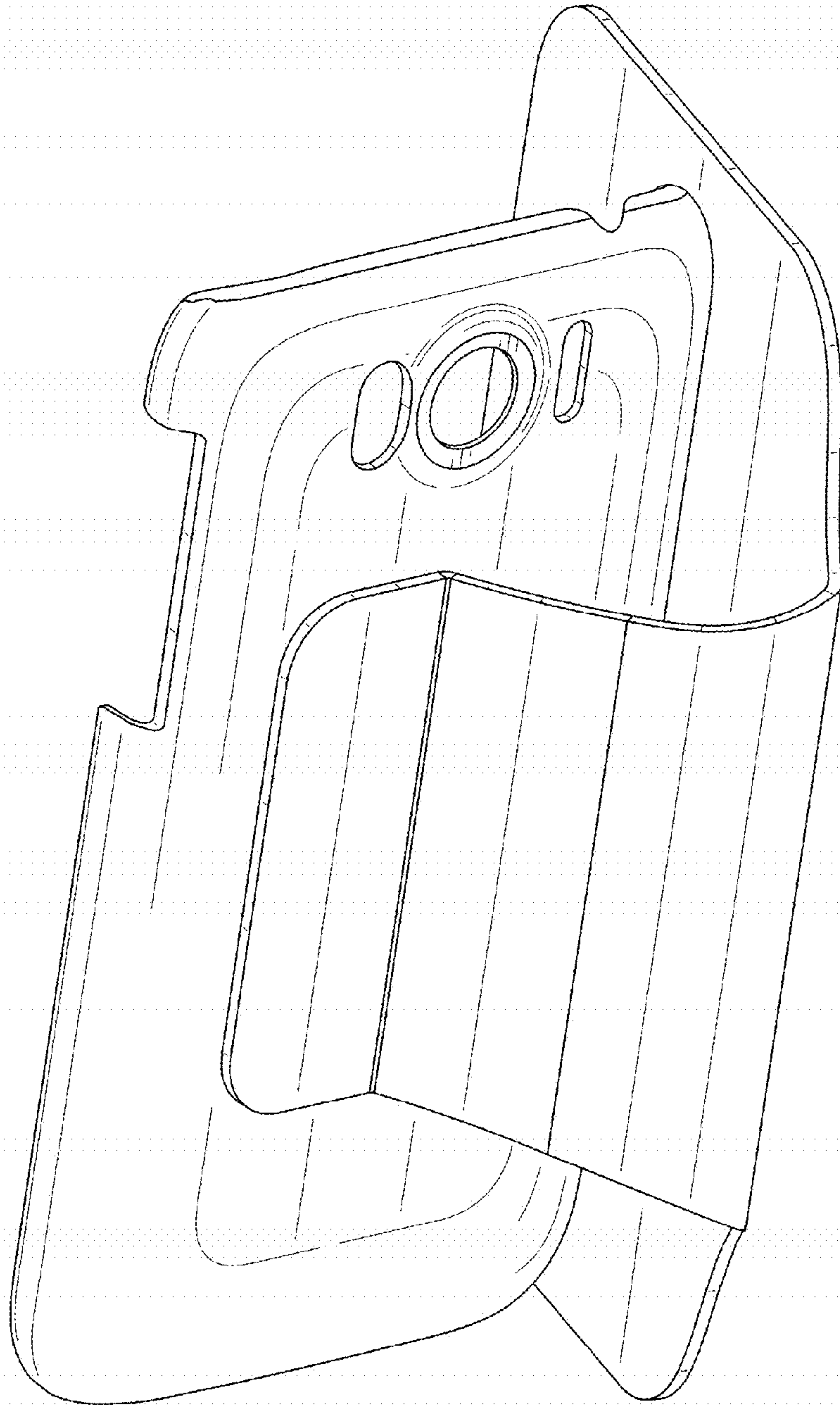

FIG. 11