



US00D711811S

(12) **United States Design Patent**  
**Maruyama et al.**

(10) **Patent No.:** **US D711,811 S**

(45) **Date of Patent:** **\*\* Aug. 26, 2014**

(54) **CONSOLE BOX FOR AUTOMOBILE**

(75) Inventors: **Souichi Maruyama**, Kanagawa-ken (JP); **Hiroyuki Kikuchi**, Tokyo (JP)

(73) Assignee: **Nissan Jidosha Kabushiki Kaisha**, Yokohama-shi, Kanagawa-ken (JP)

(\*\*) Term: **14 Years**

(21) Appl. No.: **29/414,303**

(22) Filed: **Feb. 27, 2012**

(30) **Foreign Application Priority Data**

Dec. 28, 2011 (JP) ..... 2011-030509

(51) **LOC (10) Cl.** ..... **12-16**

(52) **U.S. Cl.**  
USPC ..... **D12/424**

(58) **Field of Classification Search**  
USPC ..... D12/415-425, 191, 106, 400, 195, 345,  
D12/96, 99; 312/246; 296/97.1-97.8, 70,  
296/24.1-24.3, 24.32; 224/311, 539, 281,  
224/118.1  
See application file for complete search history.

(56) **References Cited**

**U.S. PATENT DOCUMENTS**

D474,441 S \* 5/2003 Hill et al. .... D12/415  
6,616,206 B2 \* 9/2003 Luginbill et al. .... 296/37.8  
D522,957 S \* 6/2006 Miyashita ..... D12/424

D530,660 S \* 10/2006 Norman et al. .... D12/415  
D568,232 S \* 5/2008 Motozaki et al. .... D12/421  
D581,862 S \* 12/2008 Anttila et al. .... D12/421  
D598,362 S \* 8/2009 Tan et al. .... D12/415  
D624,869 S \* 10/2010 Corradi ..... D12/415  
D632,639 S \* 2/2011 Rosenbohm ..... D12/415  
D656,457 S \* 3/2012 Crepeau ..... D12/419

\* cited by examiner

*Primary Examiner* — Katrina A Betton

(74) *Attorney, Agent, or Firm* — Fross Zelnick Lehrman & Zissu, P.C.; Lawrence E. Apolzon, Esq.

(57) **CLAIM**

The ornamental design for a console box for automobile, as shown and described.

**DESCRIPTION**

FIG. 1 is a perspective view of a console box for automobile showing our new design;  
FIG. 2 is a perspective view thereof;  
FIG. 3 is a front view thereof;  
FIG. 4 is a rear view thereof;  
FIG. 5 is a left side view thereof;  
FIG. 6 is a right side view thereof;  
FIG. 7 is a top view thereof; and,  
FIG. 8 is a bottom view thereof.  
The portions of the article in broken lines are shown for illustrative purposes only and form no part of the claimed design.

**1 Claim, 6 Drawing Sheets**

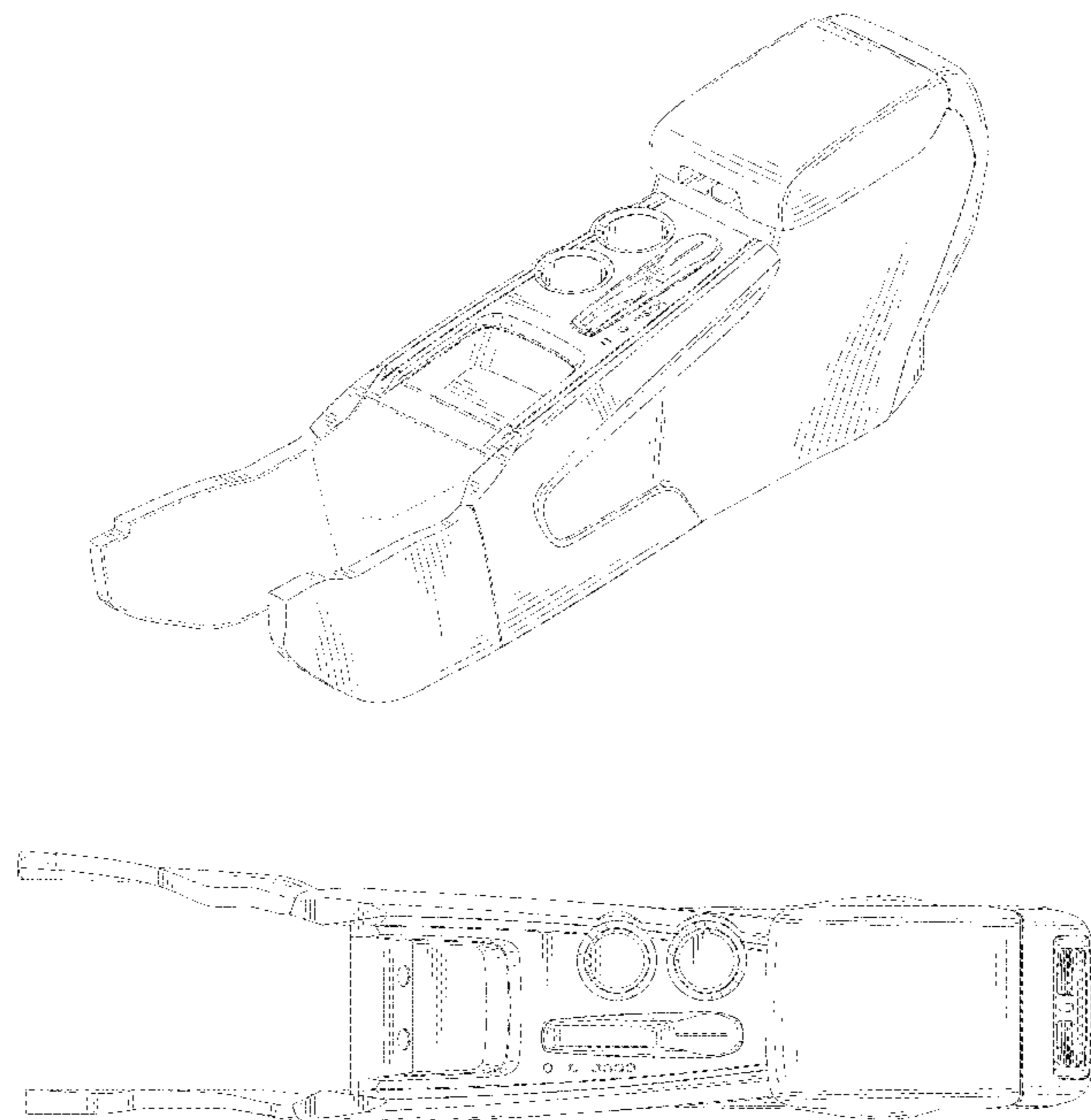

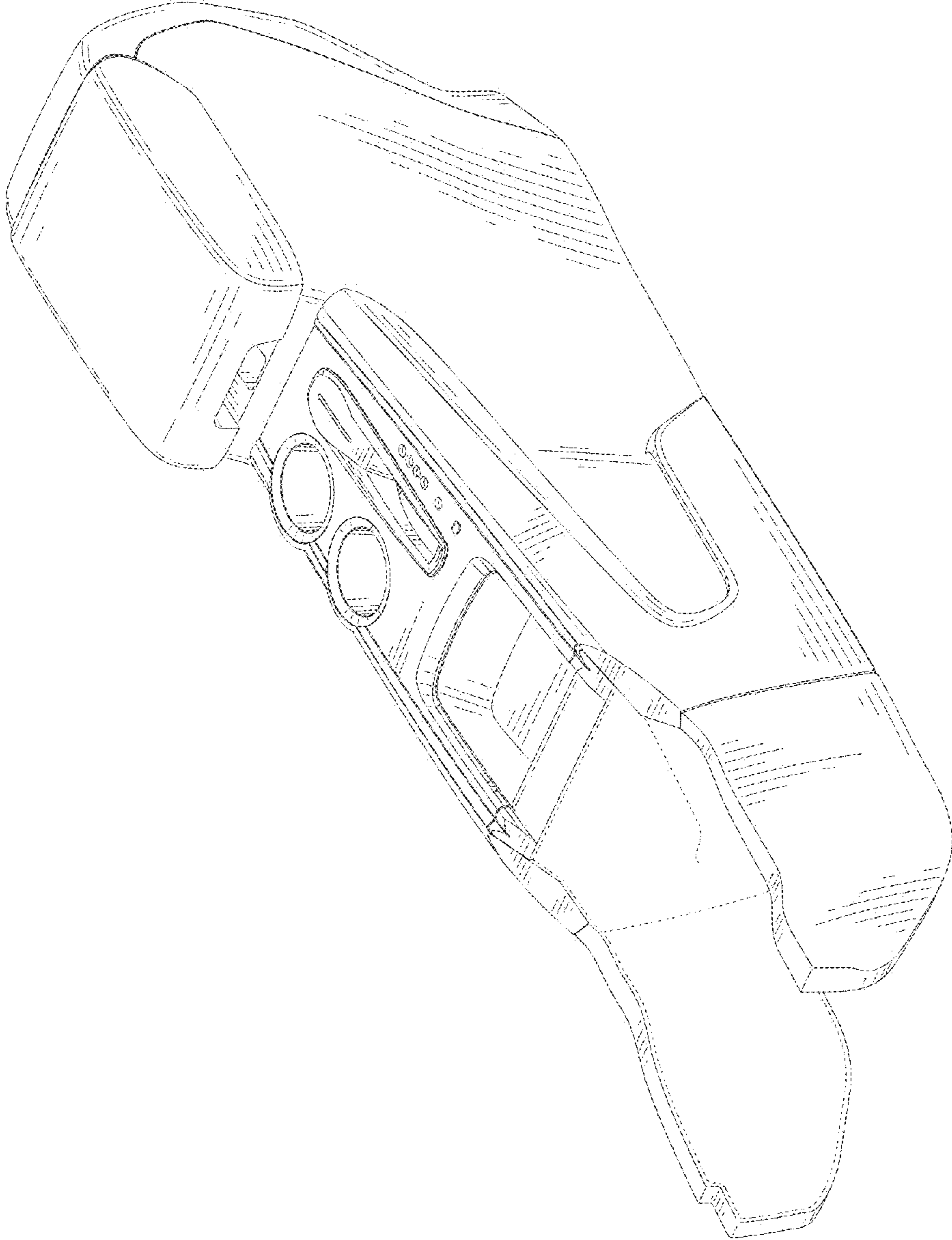

FIG. 1

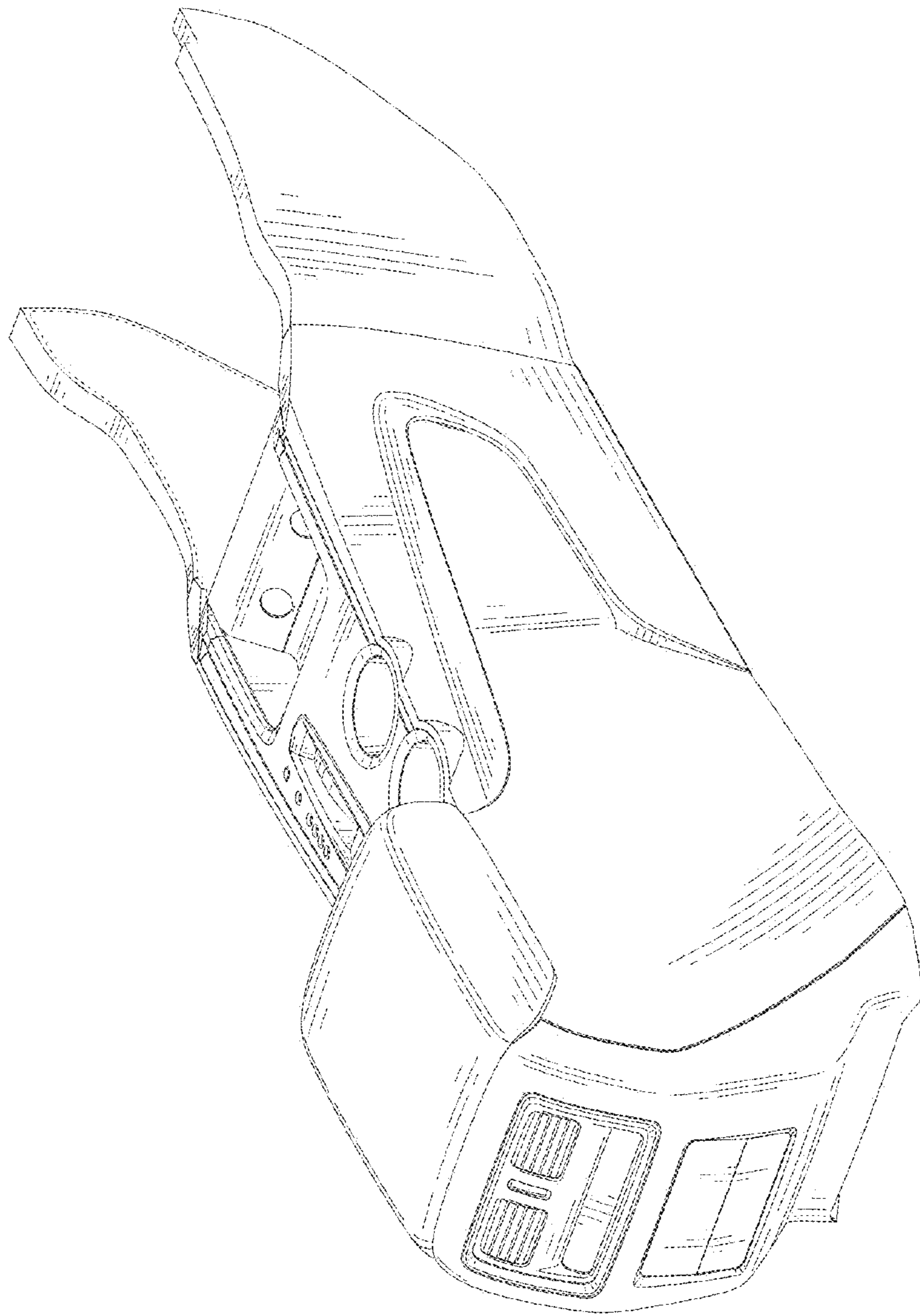

FIG. 2

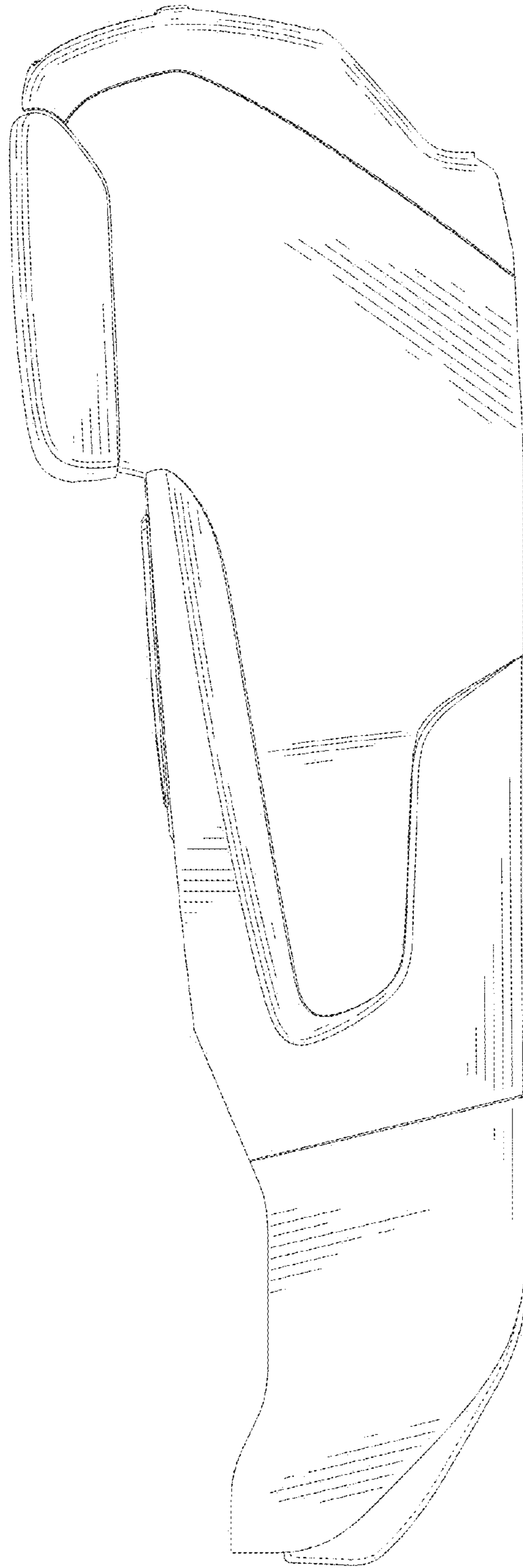

FIG. 3

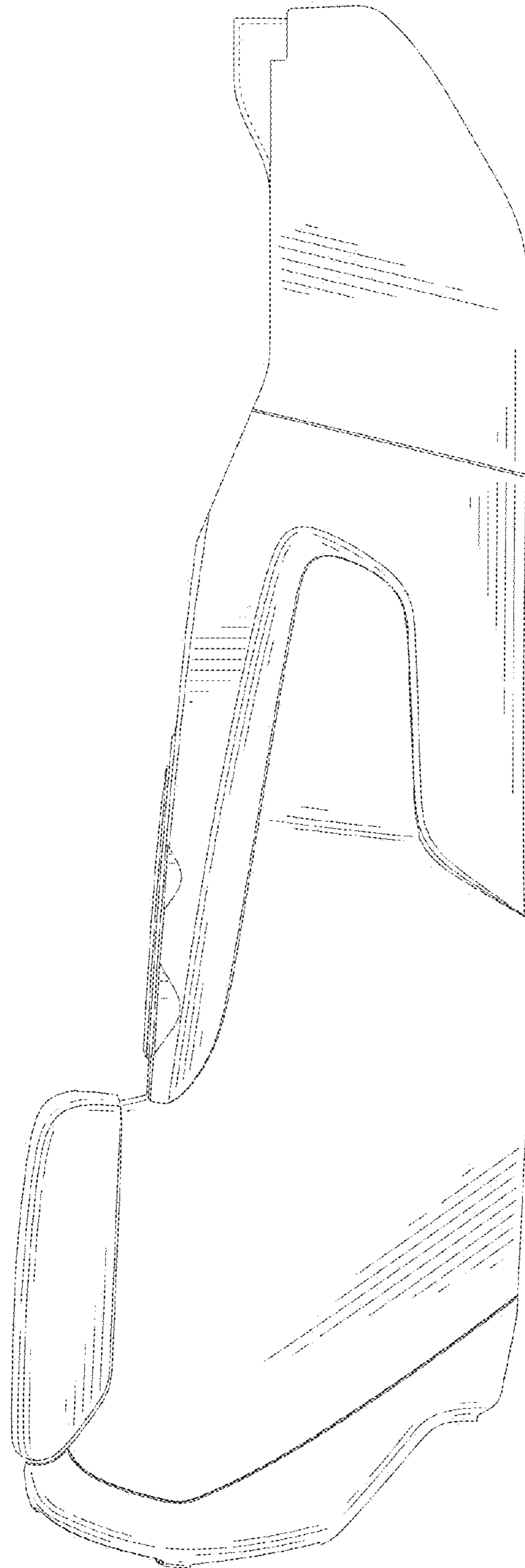

FIG. 4

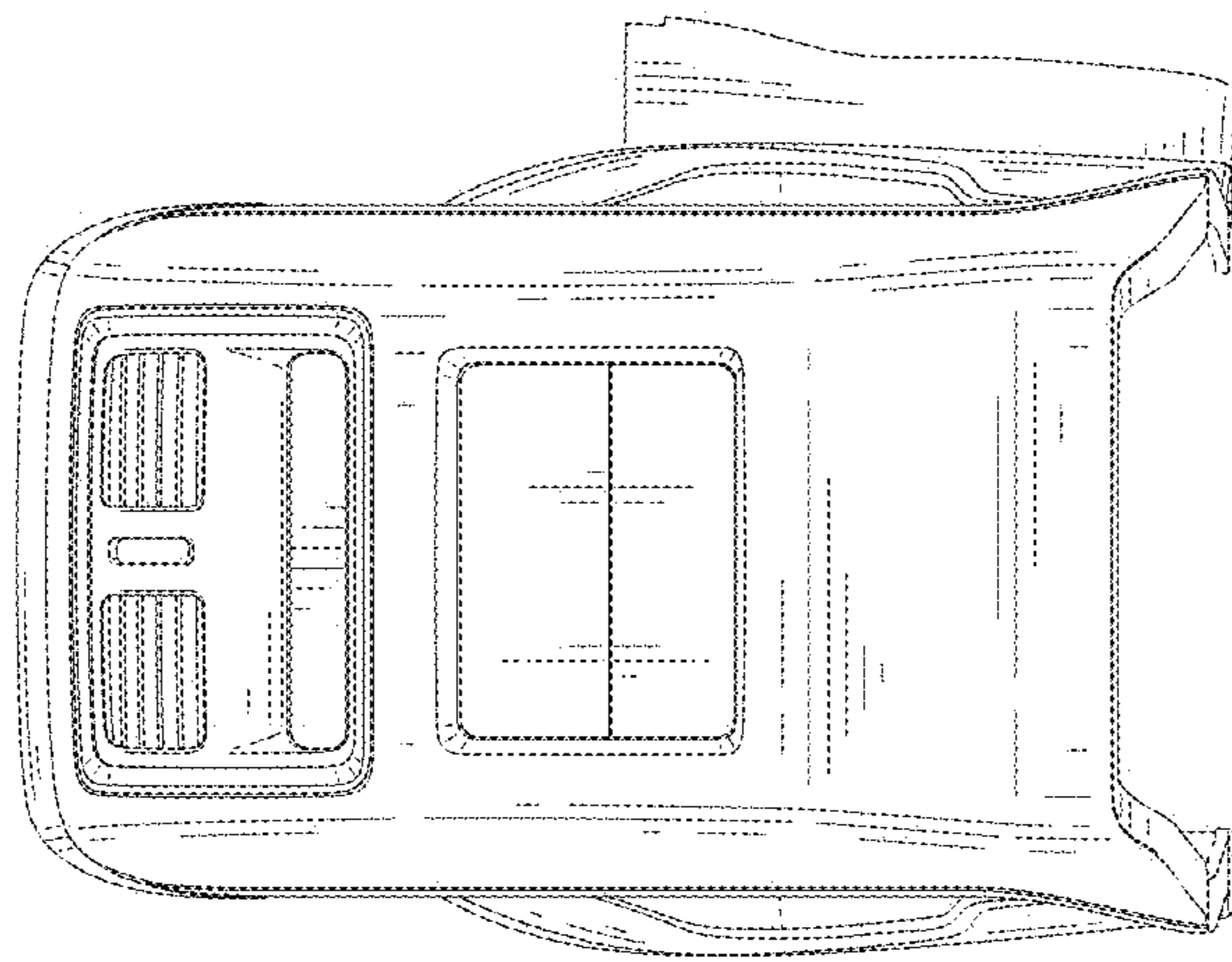

FIG. 6

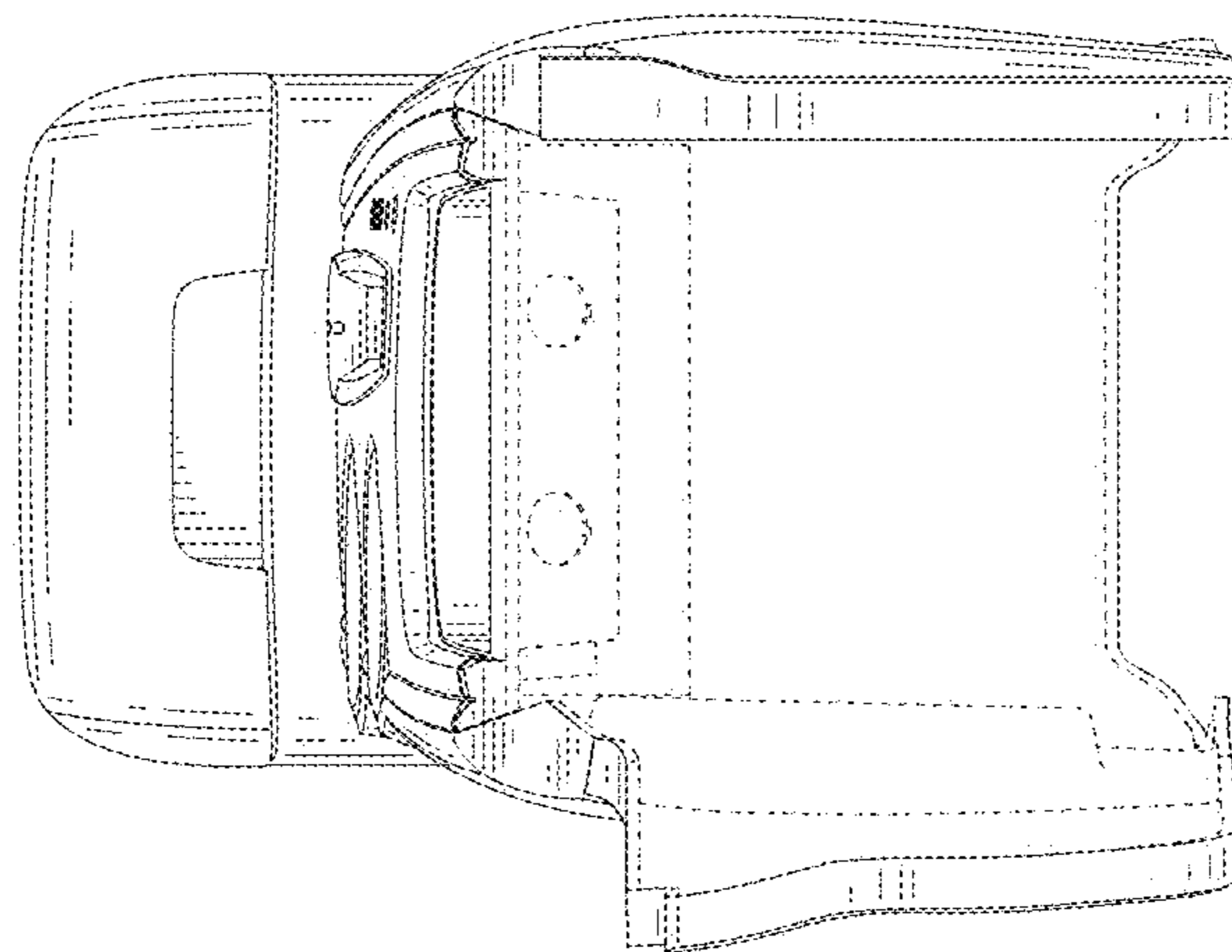

FIG. 5

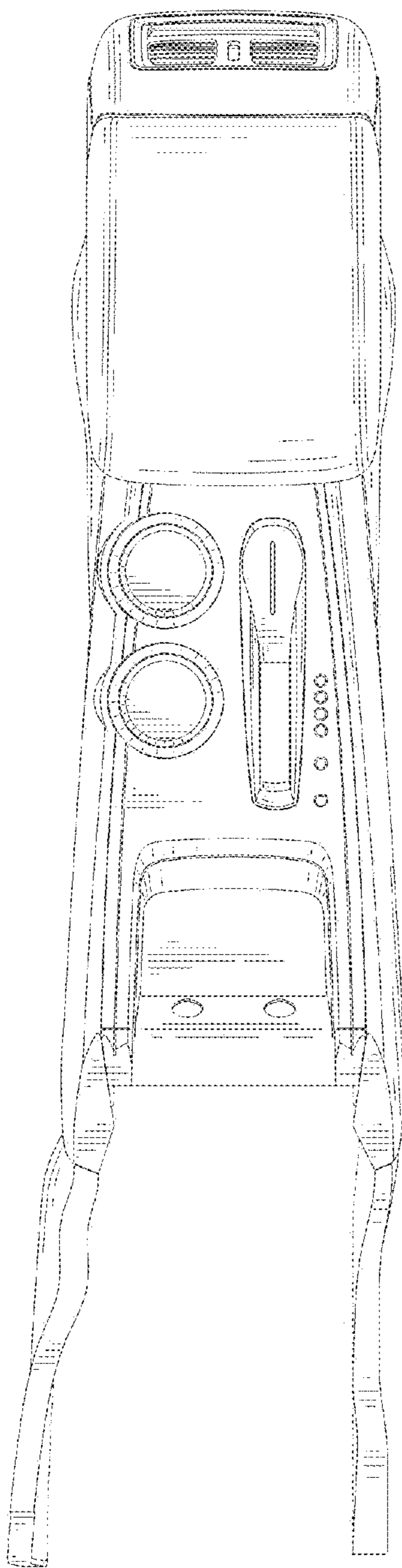

FIG. 7

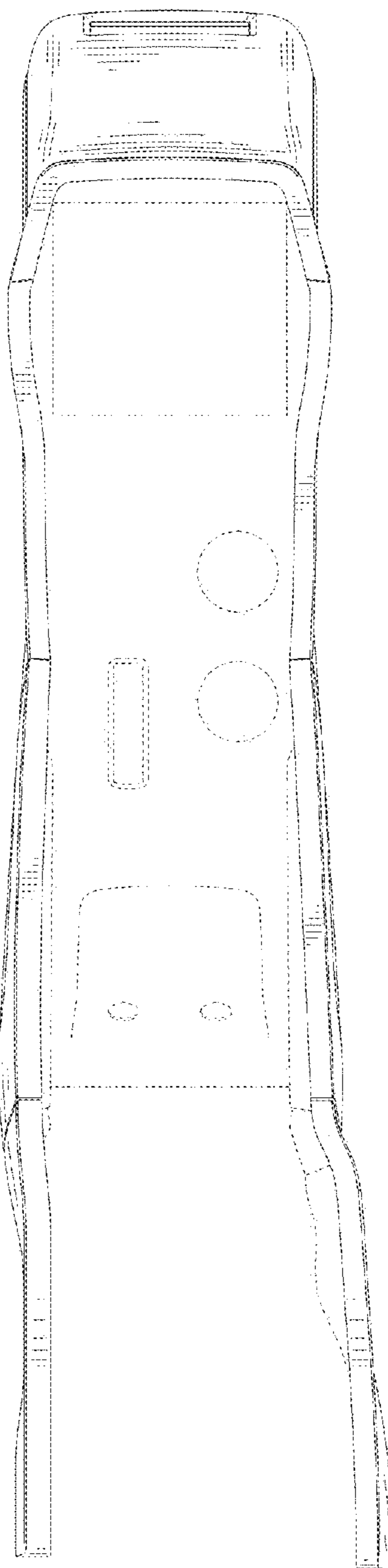

FIG. 8