



US00D711784S

(12) **United States Design Patent**
Galante et al.

(10) **Patent No.:** **US D711,784 S**

(45) **Date of Patent:** **** Aug. 26, 2014**

- (54) **AUTOMOBILE EXTERIOR**
- (71) Applicants: **Vincent J Galante**, Lake Orior, MI (US); **Mark T Allen**, Oxford, MI (US)
- (72) Inventors: **Vincent J Galante**, Lake Orior, MI (US); **Mark T Allen**, Oxford, MI (US)
- (73) Assignee: **Chrysler Group LLC**, Auburn Hills, MI (US)

D500,460 S	1/2005	Allen et al.	
D506,955 S	7/2005	Allen et al.	
D534,097 S	12/2006	Renkert et al.	
D565,467 S *	4/2008	Aneiros et al.	D12/91
D568,211 S *	5/2008	Vardis et al.	D12/91
D574,298 S *	8/2008	Opfer et al.	D12/91
D586,697 S *	2/2009	Nagode et al.	D12/91
D589,401 S *	3/2009	Yokoi et al.	D12/91
D703,583 S *	4/2014	Howell et al.	D12/91
D706,170 S *	6/2014	Girard et al.	D12/91
D706,171 S *	6/2014	Bischoff et al.	D12/91

(**) Term: **14 Years**

(21) Appl. No.: **29/459,622**

(22) Filed: **Jul. 2, 2013**

(51) **LOC (10) Cl.** **12-08**

(52) **U.S. Cl.**
USPC **D12/91**

(58) **Field of Classification Search**
USPC D12/86, 90-92, 88; D21/424, 433, 434;
296/181.1, 181.5

See application file for complete search history.

(56) **References Cited**

U.S. PATENT DOCUMENTS

D350,504 S	9/1994	Nixon
D420,939 S	2/2000	Faurote et al.
D424,992 S	5/2000	Faurote

* cited by examiner

Primary Examiner — Melody Brown

(74) *Attorney, Agent, or Firm* — Ralph E Smith

(57) **CLAIM**

The ornamental design for an automobile exterior, as shown and described.

DESCRIPTION

FIG. 1 is a front perspective view of an automobile exterior showing our new design;

FIG. 2 is a rear perspective view thereof;

FIG. 3 is a top plan view thereof;

FIG. 4 is a side view thereof;

FIG. 5 is a front view thereof; and,

FIG. 6 is a rear view thereof.

It will be understood that the broken lines shown in the drawings illustrate portions of the automobile exterior that form no part of claimed design.

1 Claim, 5 Drawing Sheets

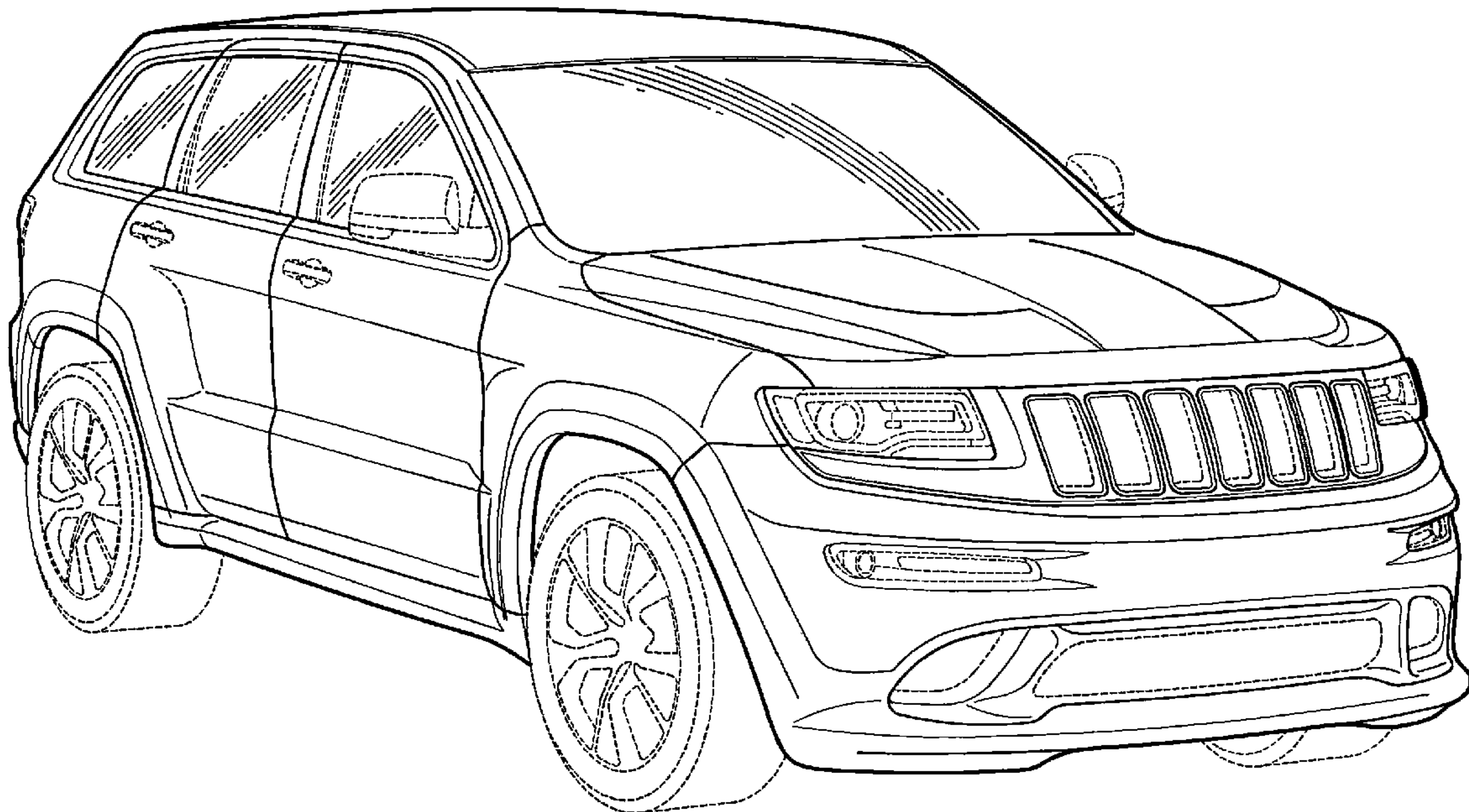

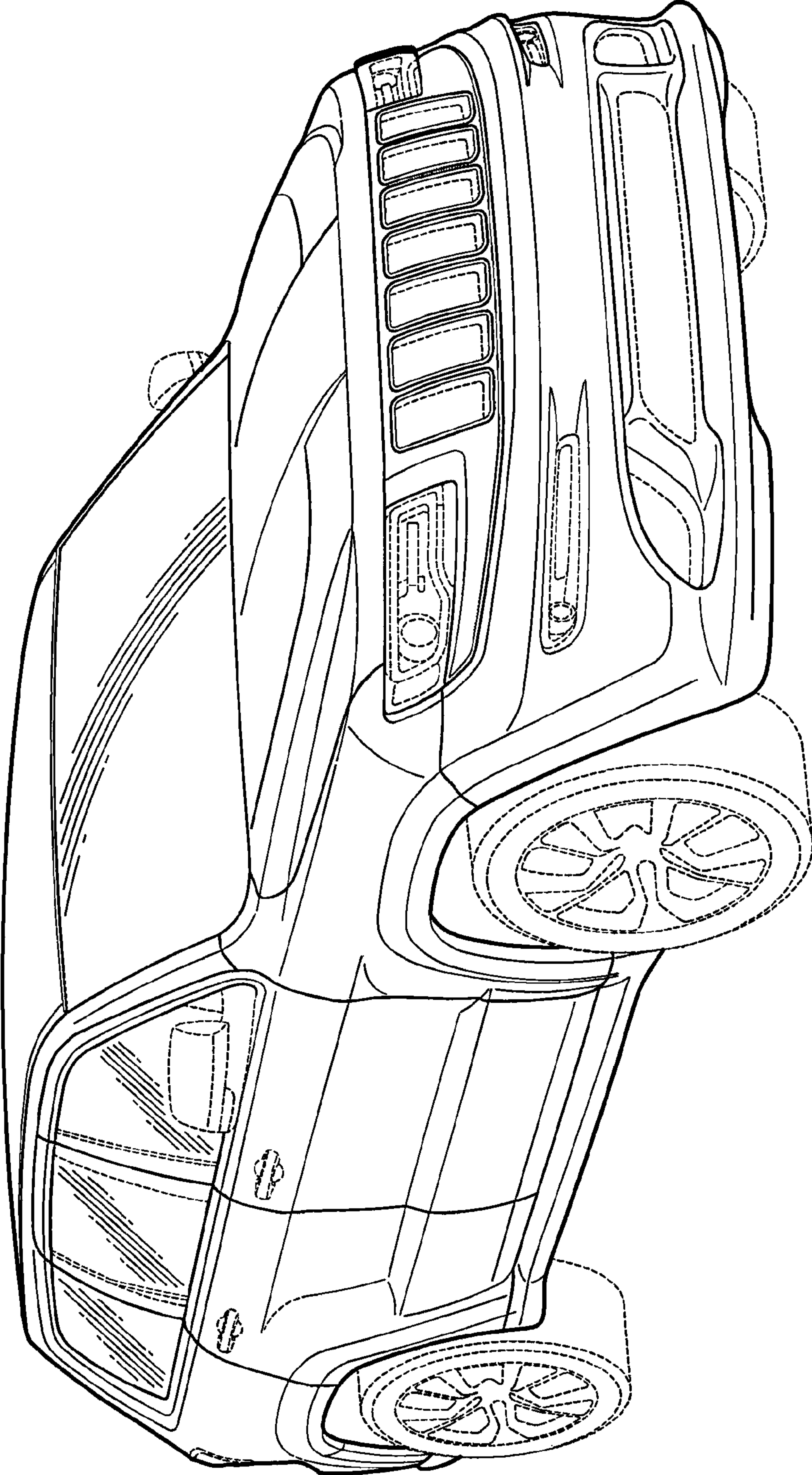

FIG. 1

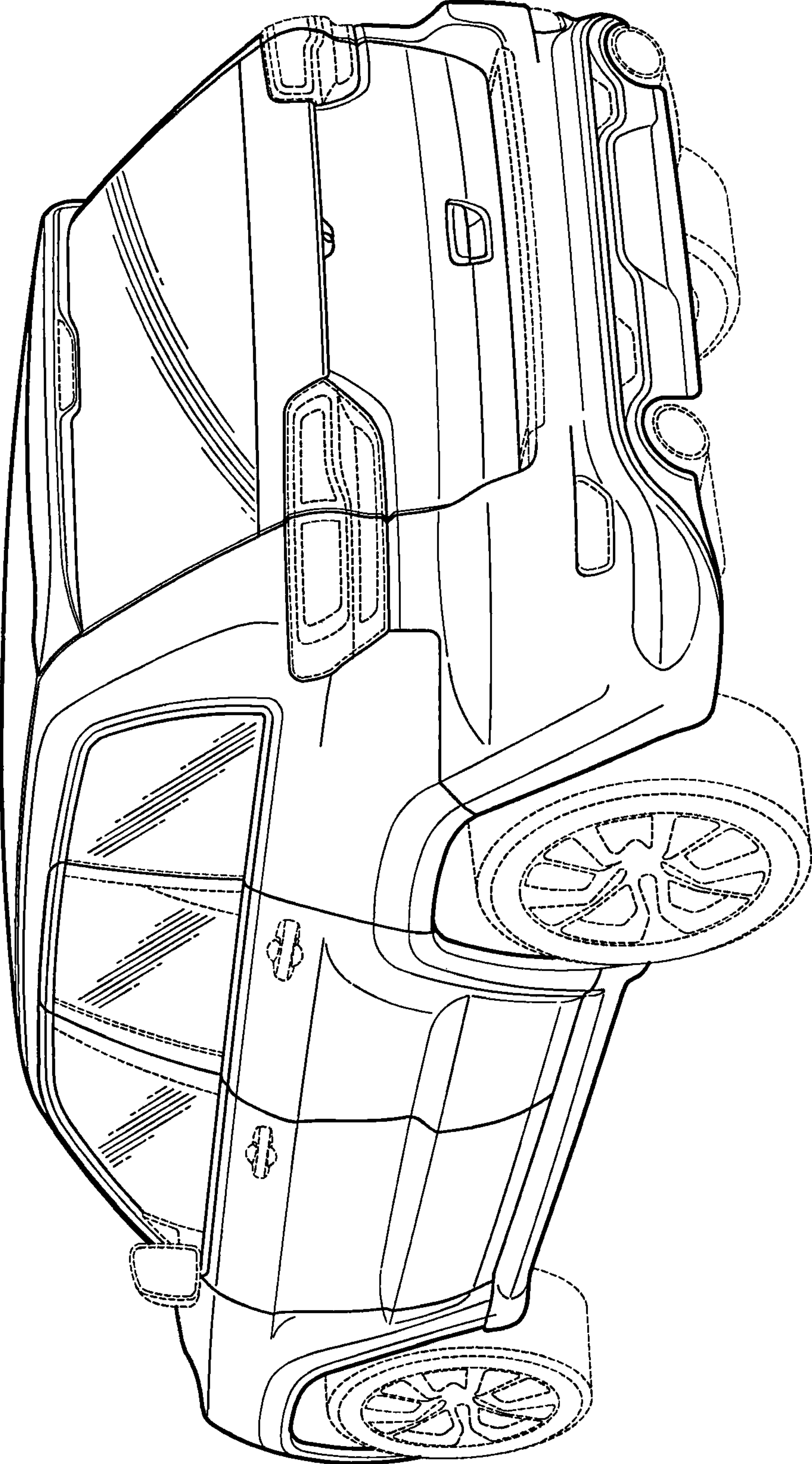

FIG. 2

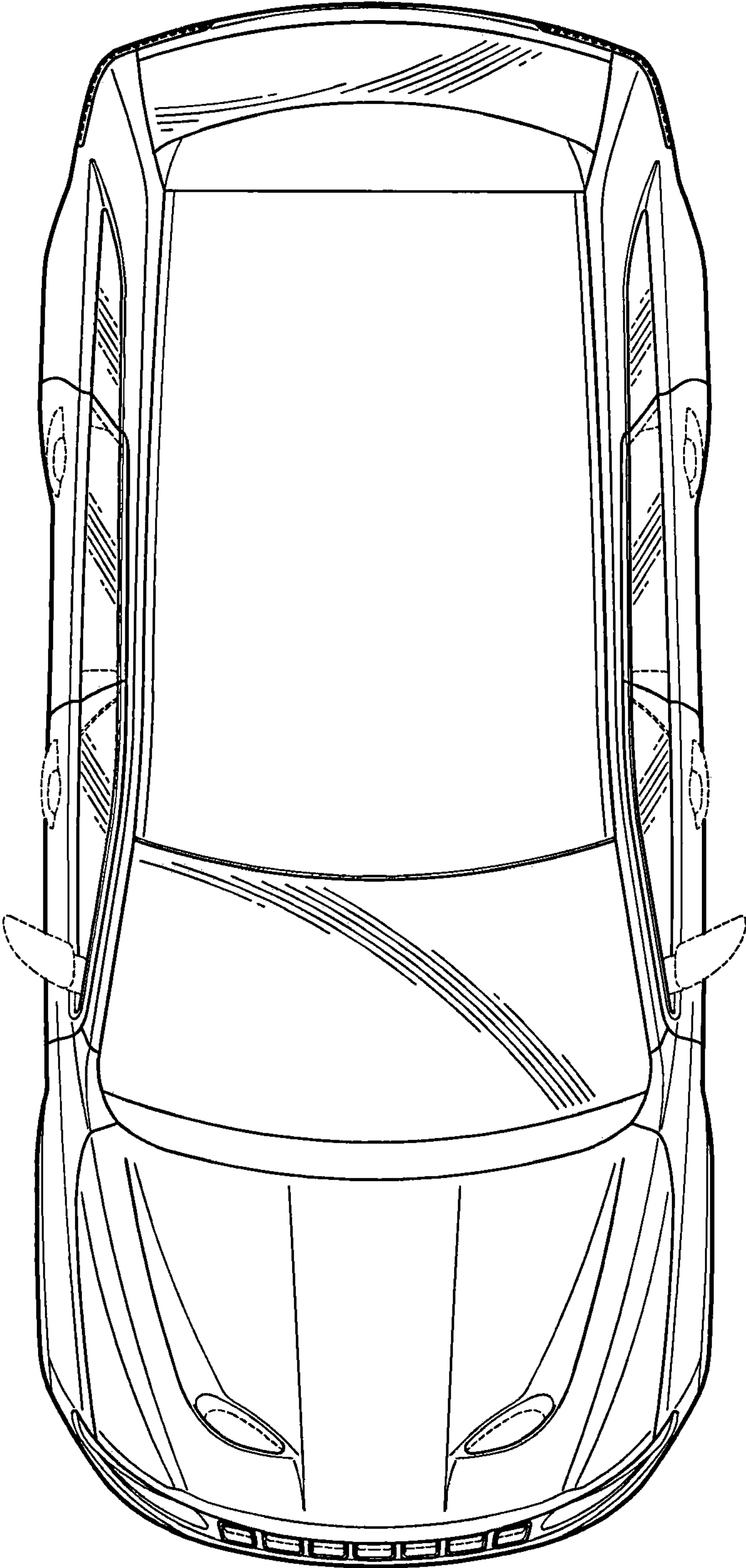

FIG. 3

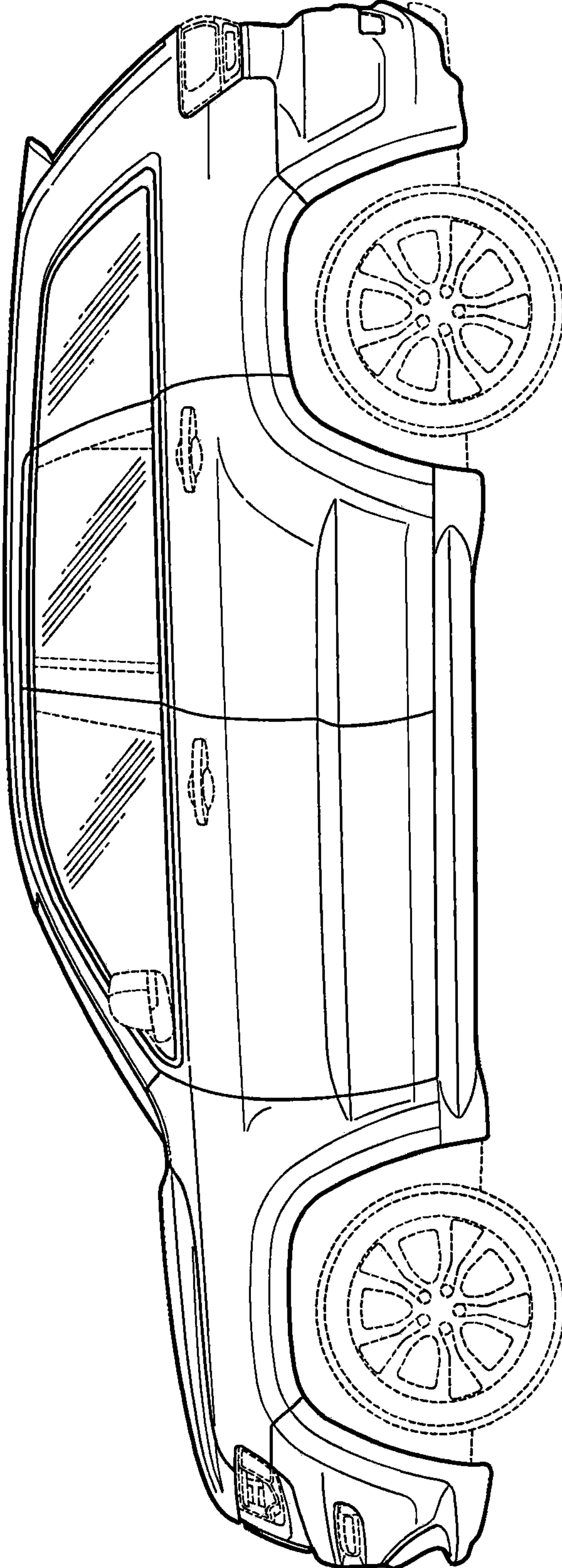

FIG. 4

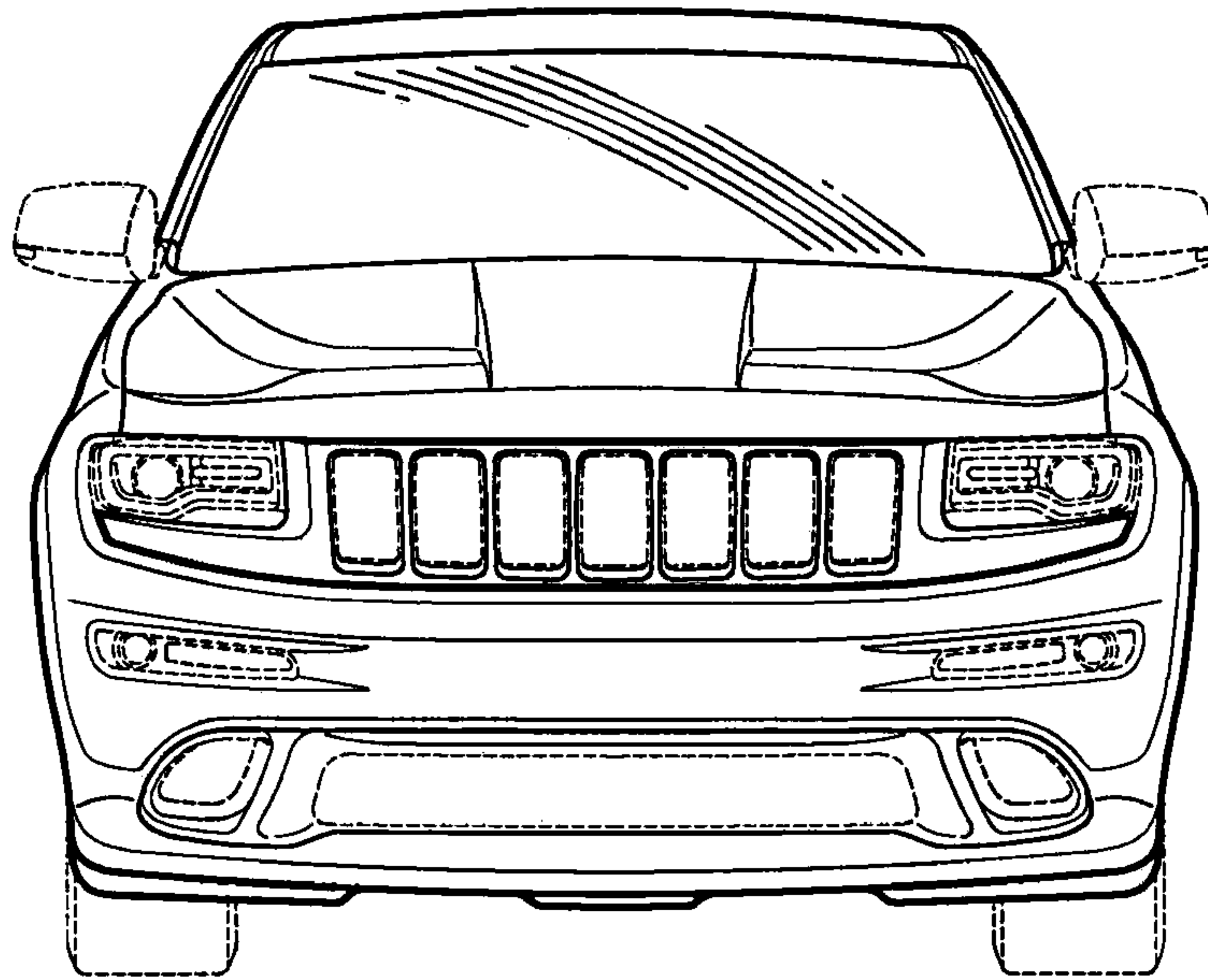

FIG. 5

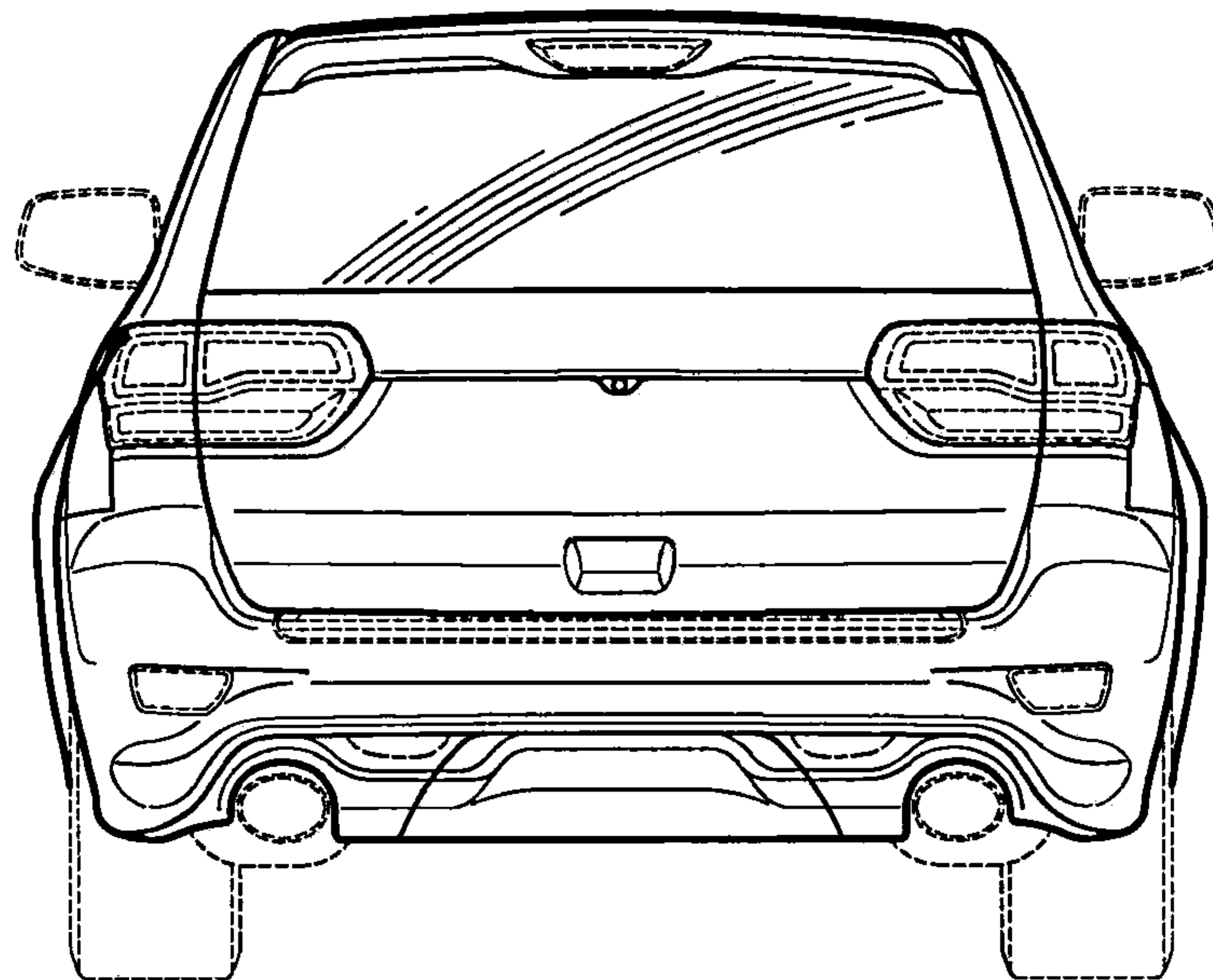

FIG. 6