



US00D711692S

(12) **United States Design Patent**
Ostlundt

(10) **Patent No.:** **US D711,692 S**

(45) **Date of Patent:** **** Aug. 26, 2014**

(54) **KNIFE BLOCK**

(71) Applicant: **Frederick Ostlundt**, London (GB)

(72) Inventor: **Frederick Ostlundt**, London (GB)

(73) Assignee: **Edge of Belgravia Limited**, London (GB)

(**) Term: **14 Years**

(21) Appl. No.: **29/464,059**

(22) Filed: **Aug. 12, 2013**

(51) **LOC (10) Cl.** **07-99**

(52) **U.S. Cl.**
USPC **D7/640**

(58) **Field of Classification Search**
CPC A47G 21/14
USPC D7/637-641, 600.1-600.4; 30/298.4,
30/396.1; 248/37.3, 37.6, 174;
211/69.1-69.9, 70.7, 71.01, 41.2, 41.3,
211/41.7, 60.1, 70.6

See application file for complete search history.

(56) **References Cited**

U.S. PATENT DOCUMENTS

6,920,987 B2 * 7/2005 Siegel et al. 211/70.7
D646,935 S * 10/2011 Hatch et al. D7/637

* cited by examiner

Primary Examiner — Terry Wallace

(74) *Attorney, Agent, or Firm* — Inventa Capital PLC

(57) **CLAIM**

I claim the ornamental design for a knife block, as shown and described.

DESCRIPTION

FIG. 1 is a left side view of a knife block of the present invention;

FIG. 2 is a front view of the knife block of FIG. 1;

FIG. 3 is a right side view of the knife block of FIG. 1;

FIG. 4 is a back view of the knife block of FIG. 1;

FIG. 5 is a top side view of the knife block of FIG. 1;

FIG. 6 is a bottom view of the knife block of FIG. 1; and,

FIG. 7 is a perspective view of the knife block of FIG. 1.

1 Claim, 1 Drawing Sheet

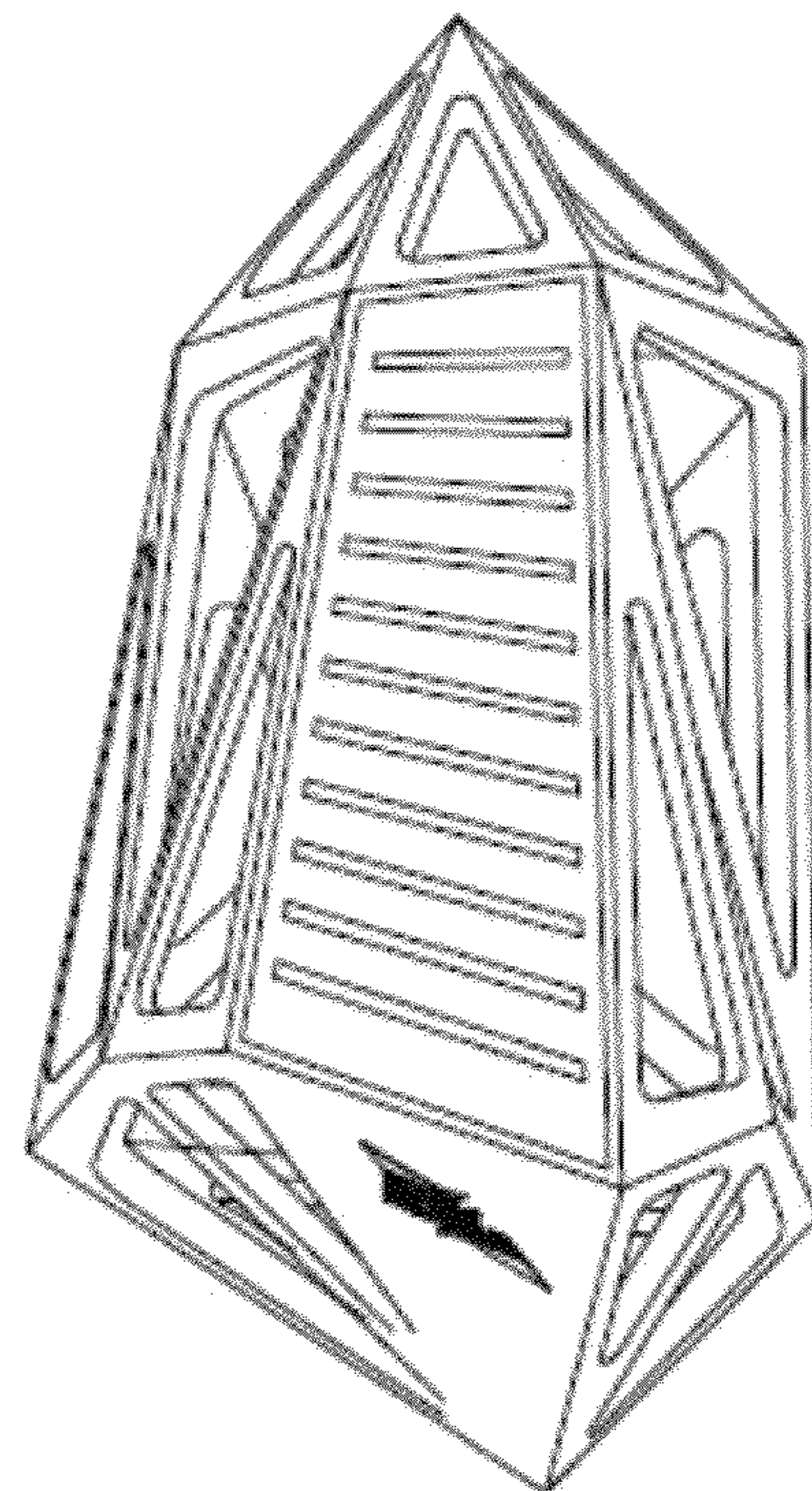
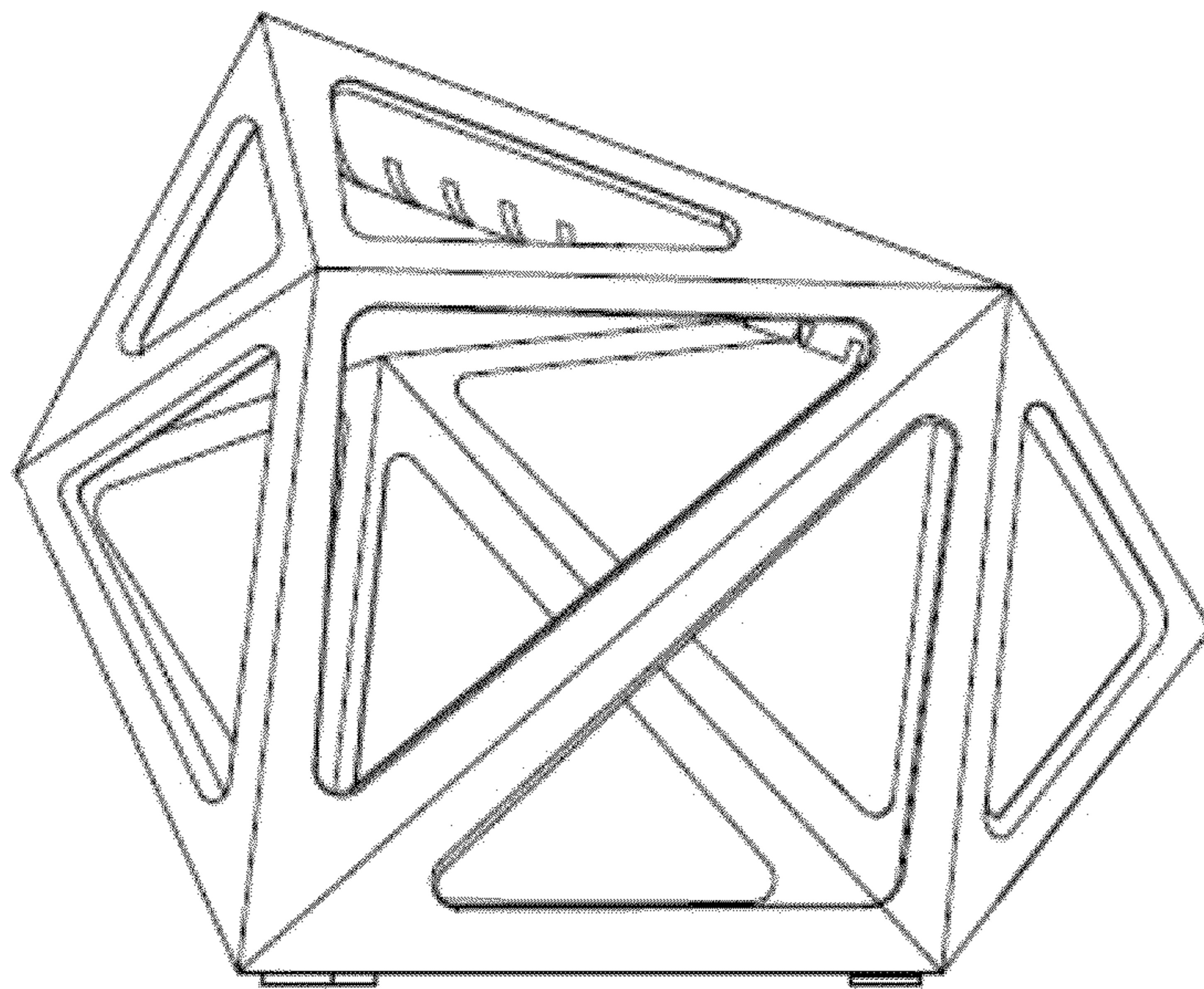

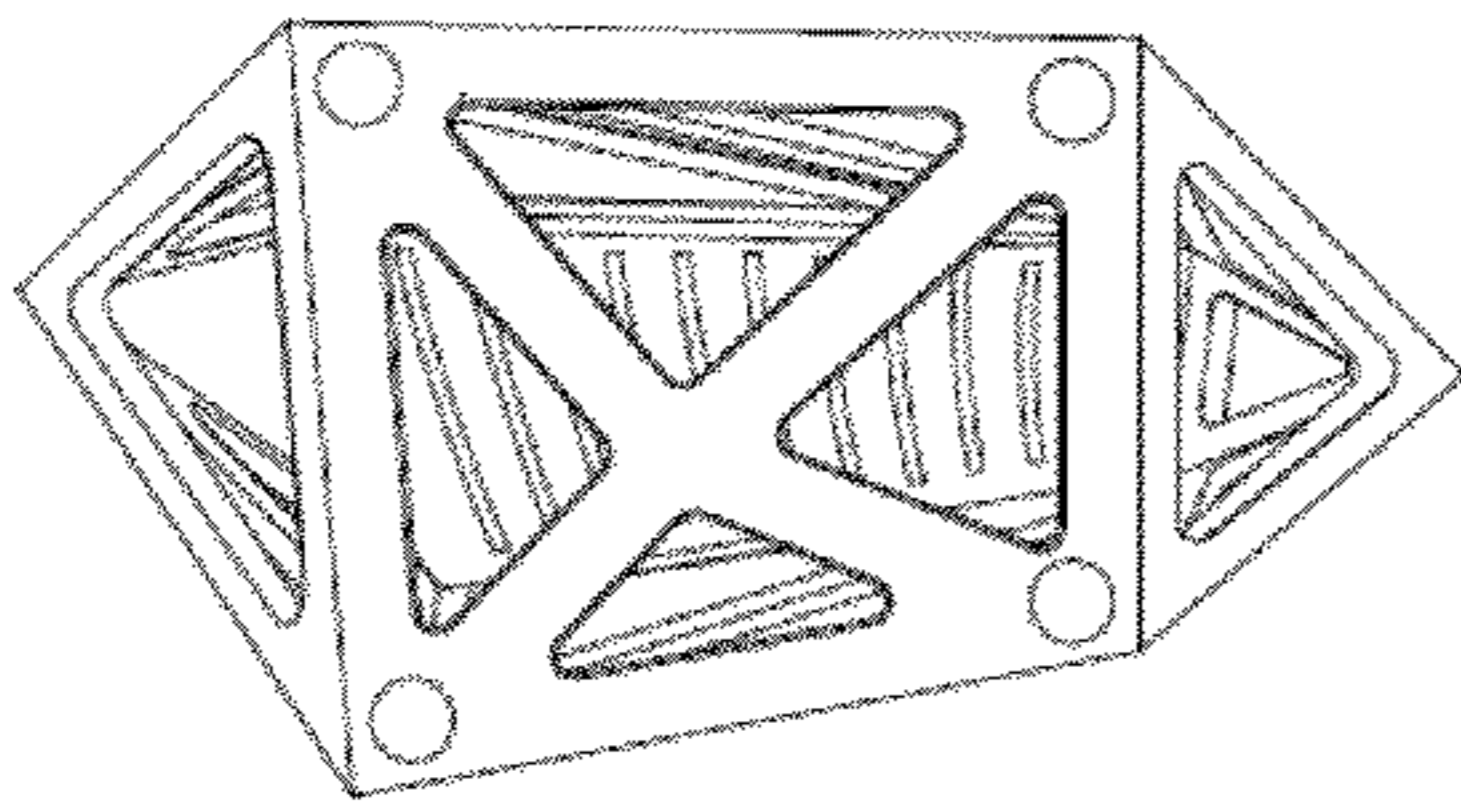

FIG. 6

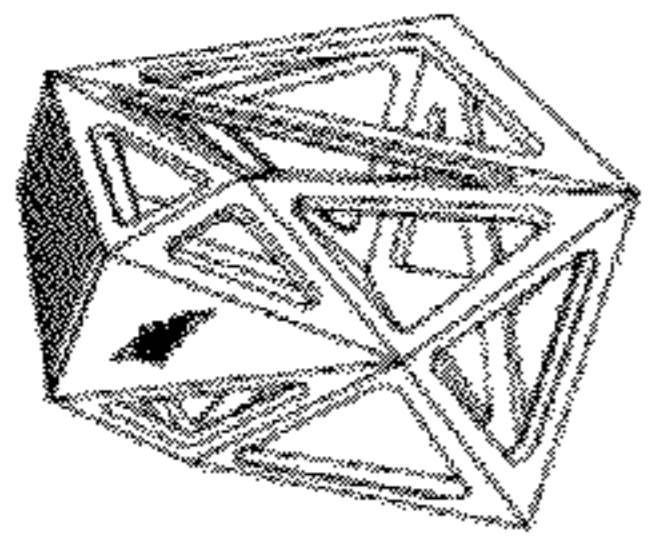

FIG. 7

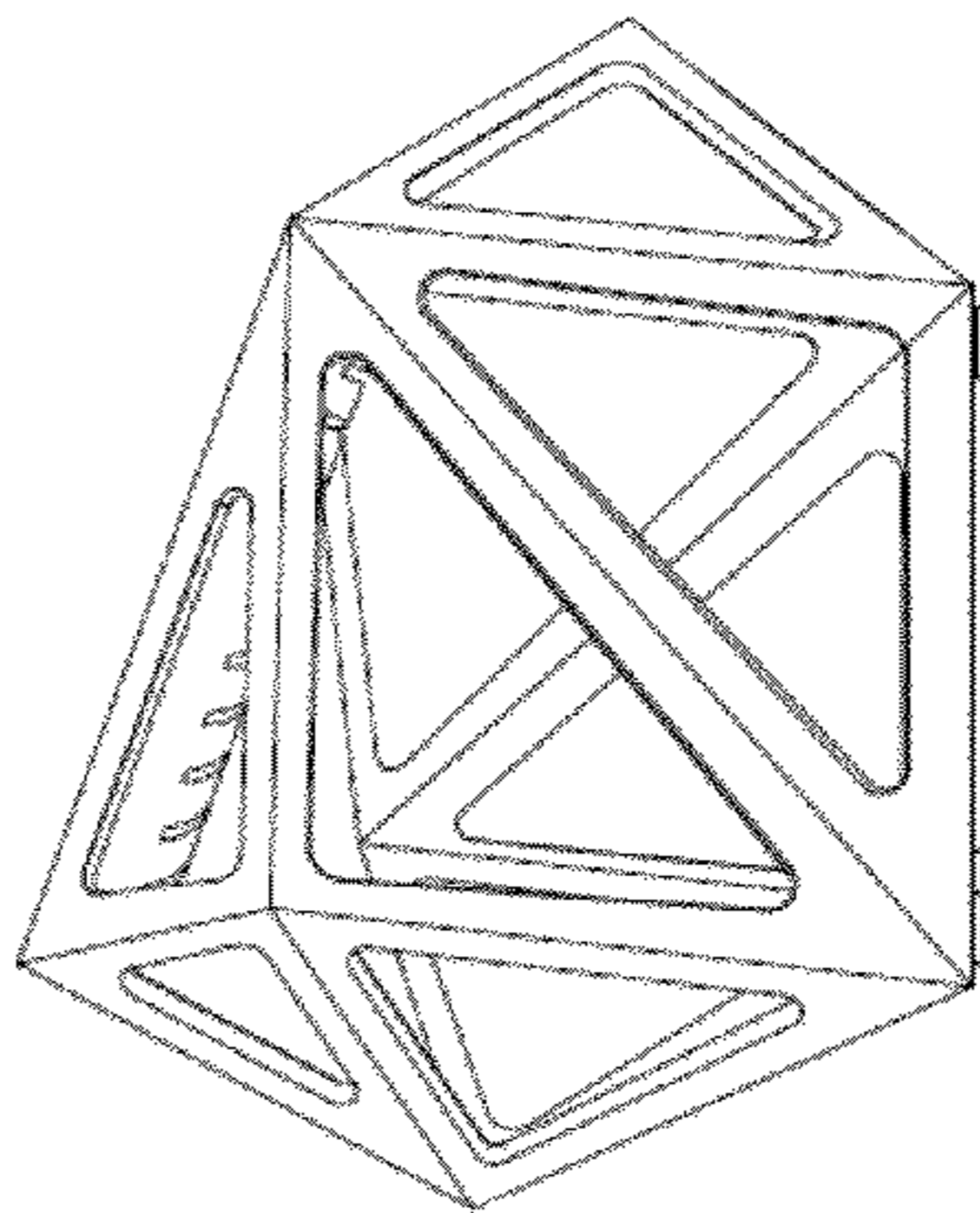

FIG. 1

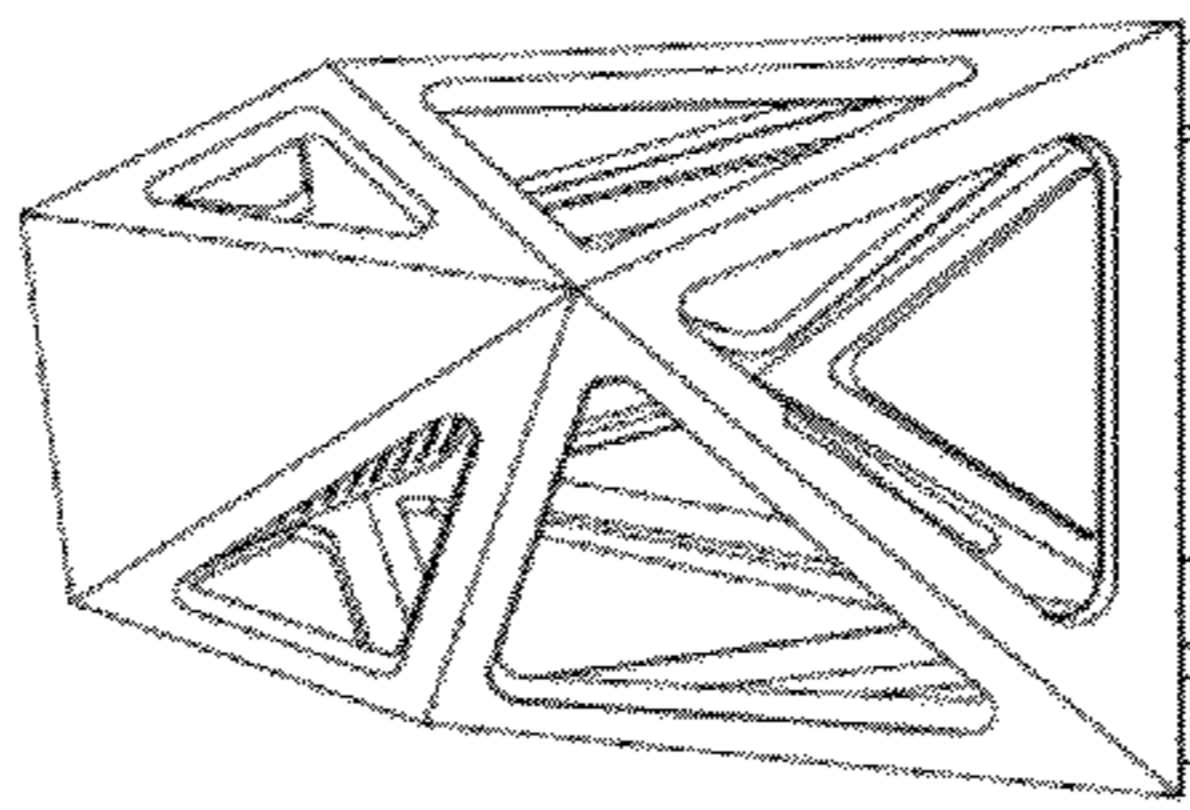

FIG. 2

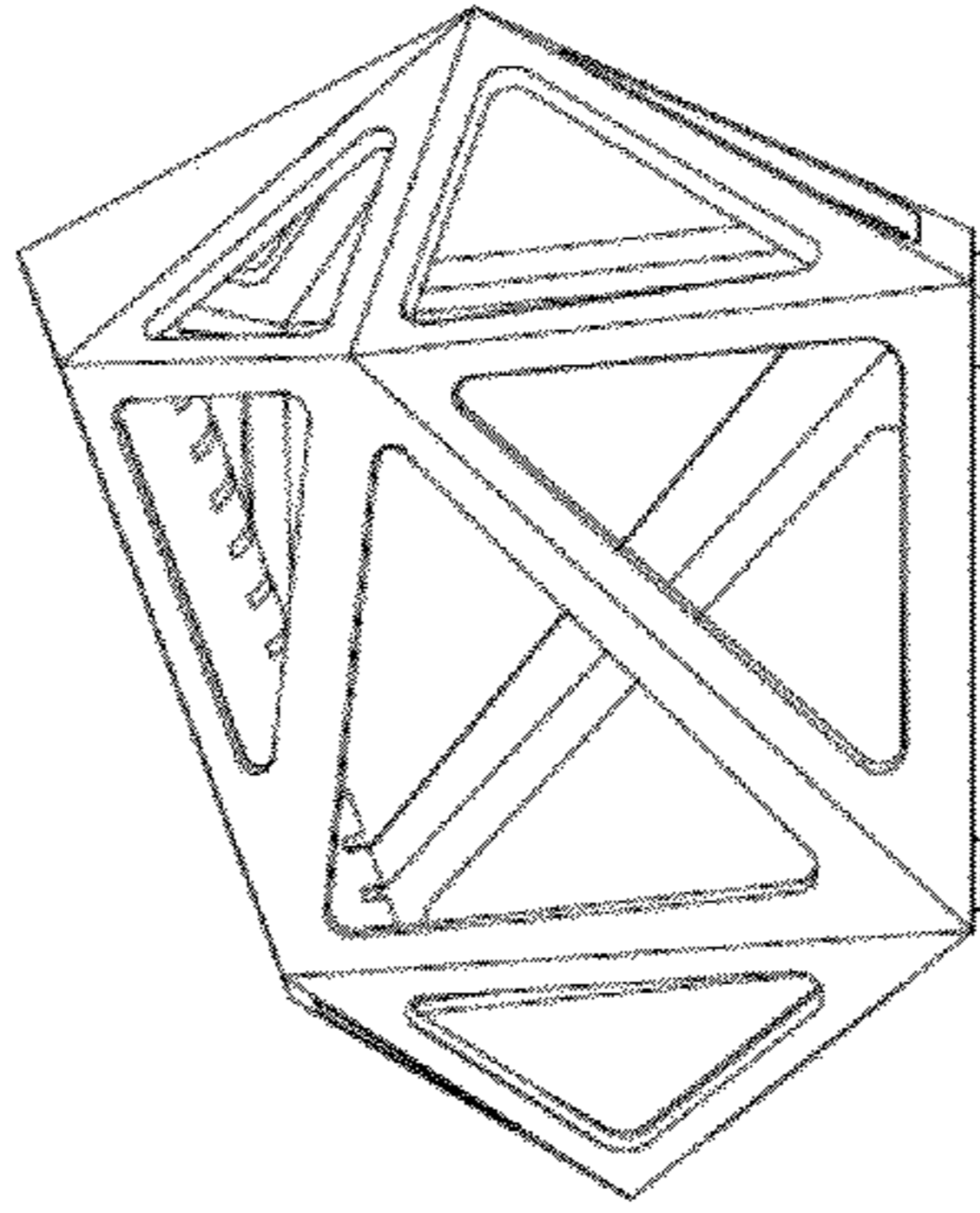

FIG. 3

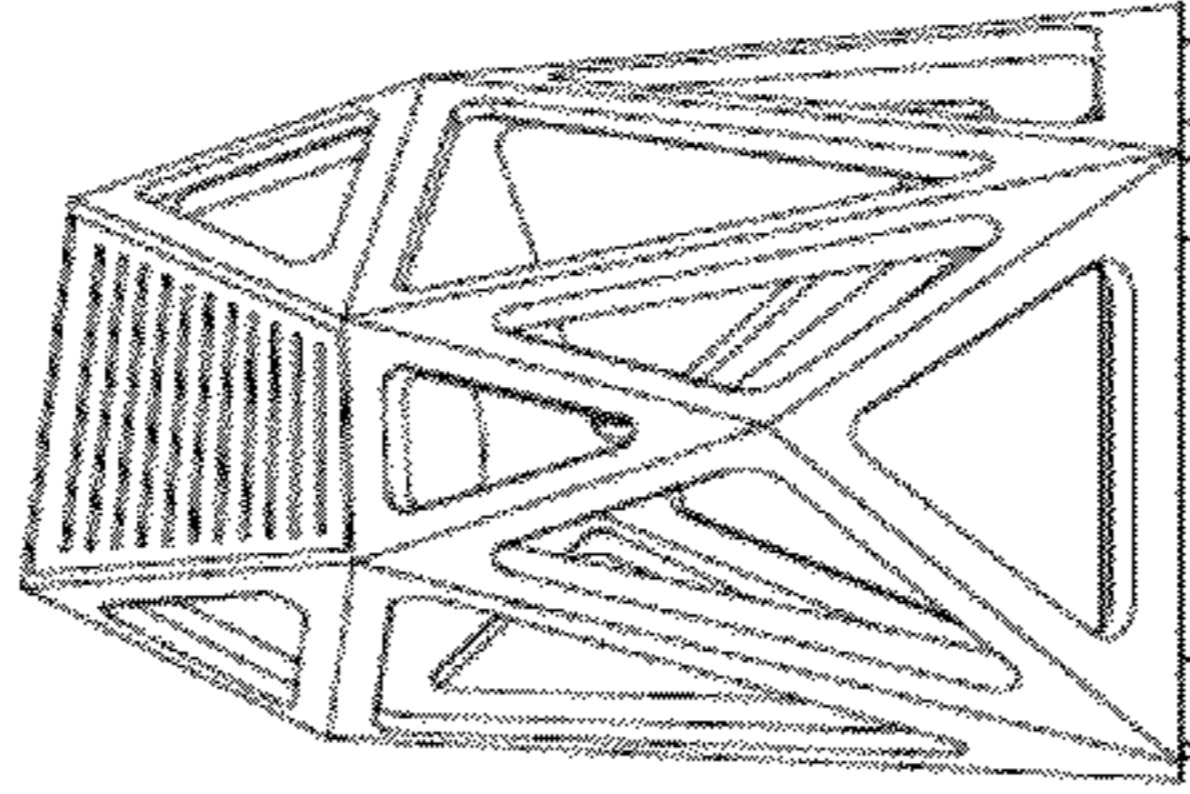

FIG. 4

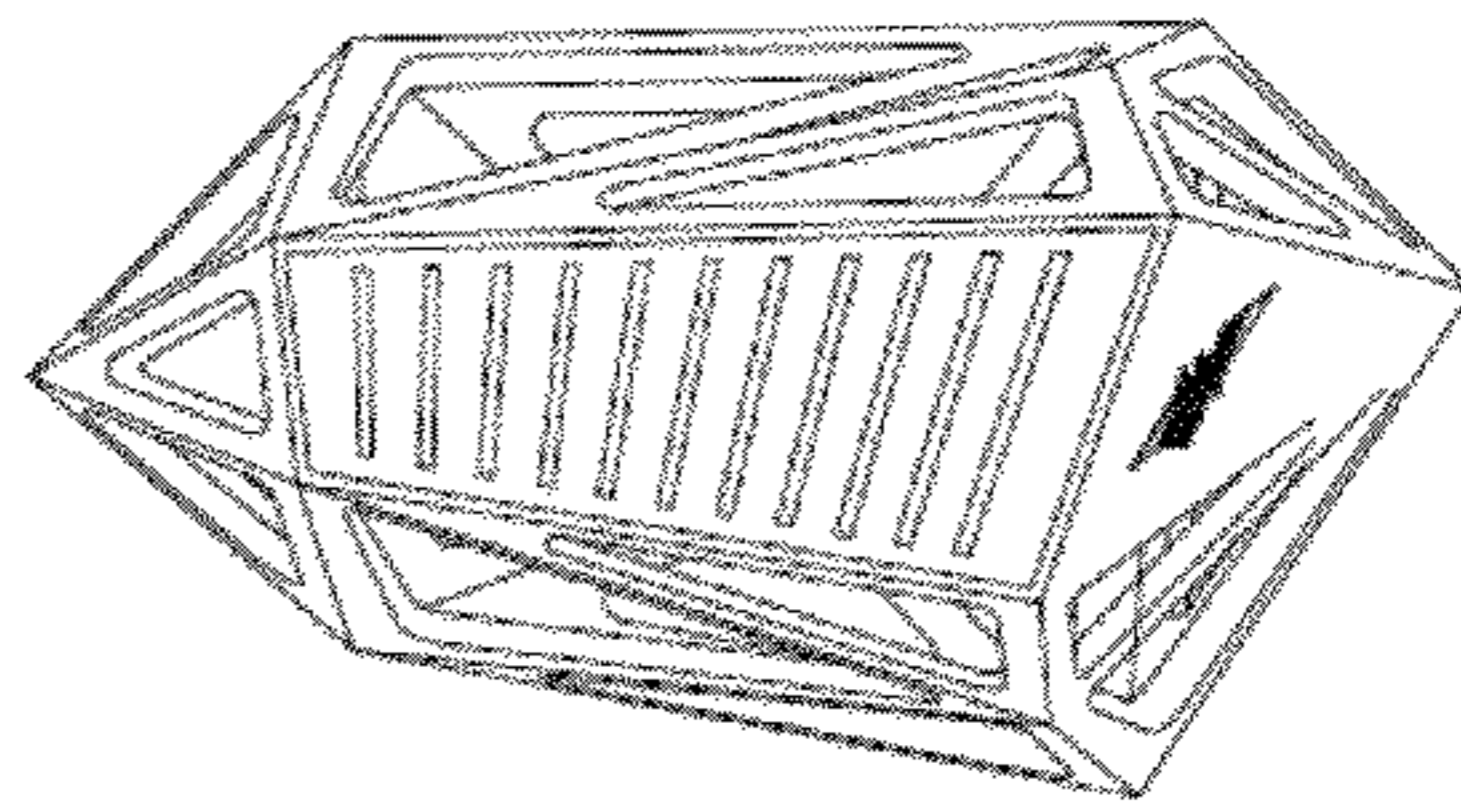

FIG. 5