



US00D711623S

(12) **United States Design Patent**  
**Kaufman**

(10) **Patent No.:** **US D711,623 S**

(45) **Date of Patent:** **\*\* Aug. 26, 2014**

(54) **SHAPED FOOD PRODUCT**

(71) Applicant: **Sargento Foods, Inc.**, Plymouth, WI (US)

(72) Inventor: **Brian Kaufman**, Plymouth, WI (US)

(73) Assignee: **Sargento Foods Inc.**, Plymouth, WI (US)

(\*\*) Term: **14 Years**

(21) Appl. No.: **29/481,317**

(22) Filed: **Feb. 4, 2014**

**Related U.S. Application Data**

(62) Division of application No. 29/445,848, filed on Feb. 18, 2013.

(51) **LOC (10) Cl.** ..... **01-01**

(52) **U.S. Cl.**  
USPC ..... **D1/199**

(58) **Field of Classification Search**

CPC ..... A21D 13/0029; A21D 13/0074; A21D 13/0022; A21D 13/0006; A23L 1/1641; A23L 1/005

USPC ..... D1/100-130, 199; 426/5, 76, 87, 92, 426/94, 95, 99, 101, 103, 104, 108, 134, 426/138-139, 143, 144, 279, 282, 283, 391, 426/514, 549, 559, 560, 660, 808; D28/8.1; D6/596, 601, 518; D21/501; D23/207; D24/101-104; 52/607

See application file for complete search history.

(56) **References Cited**

**U.S. PATENT DOCUMENTS**

D192,941 S \* 5/1962 Schneider ..... D9/707  
D199,935 S \* 12/1964 Dykes et al. .... D9/707

(Continued)

*Primary Examiner* — Deanna L Pratt

*Assistant Examiner* — Katie Mroczka

(74) *Attorney, Agent, or Firm* — Reinhart Boerner Van Deuren s.c.

(57) **CLAIM**

The ornamental design for the shaped food product, as shown and described.

**DESCRIPTION**

FIG. 1 is a perspective view of an embodiment of the claimed design;

FIG. 2 is a front view of the embodiment of the claimed design of FIG. 1;

FIG. 3 is a rear view of the embodiment of the claimed design of FIG. 1;

FIG. 4 is a left side view of the embodiment of the claimed design of FIG. 1;

FIG. 5 is a right side view of the embodiment of the claimed design of FIG. 1;

FIG. 6 is a top view of the embodiment of the claimed design of FIG. 1;

FIG. 7 is a bottom view of the embodiment of the claimed design of FIG. 1;

FIG. 8 is a perspective view of another embodiment of the claimed design;

FIG. 9 is a front view of the embodiment of the claimed design of FIG. 8;

FIG. 10 is a rear view of the embodiment of the claimed design of FIG. 8;

FIG. 11 is a left side view of the embodiment of the claimed design of FIG. 8;

FIG. 12 is a right side view of the embodiment of the claimed design of FIG. 8;

FIG. 13 is a top view of the embodiment of the claimed design of FIG. 8;

FIG. 14 is a bottom view of the embodiment of the claimed design of FIG. 8;

FIG. 15 is a perspective view of still another embodiment of the claimed design;

FIG. 16 is a front view of the embodiment of the claimed design of FIG. 15;

FIG. 17 is a rear view of the embodiment of the claimed design of FIG. 15;

FIG. 18 is a left side view of the embodiment of the claimed design of FIG. 15;

FIG. 19 is a right side view of the embodiment of the claimed design of FIG. 15;

FIG. 20 is a top view of the embodiment of the claimed design of FIG. 15; and,

FIG. 21 is a bottom view of the embodiment of the claimed design of FIG. 15.

The ornamental design which is claimed is shown in solid lines in the drawings.

**1 Claim, 21 Drawing Sheets**

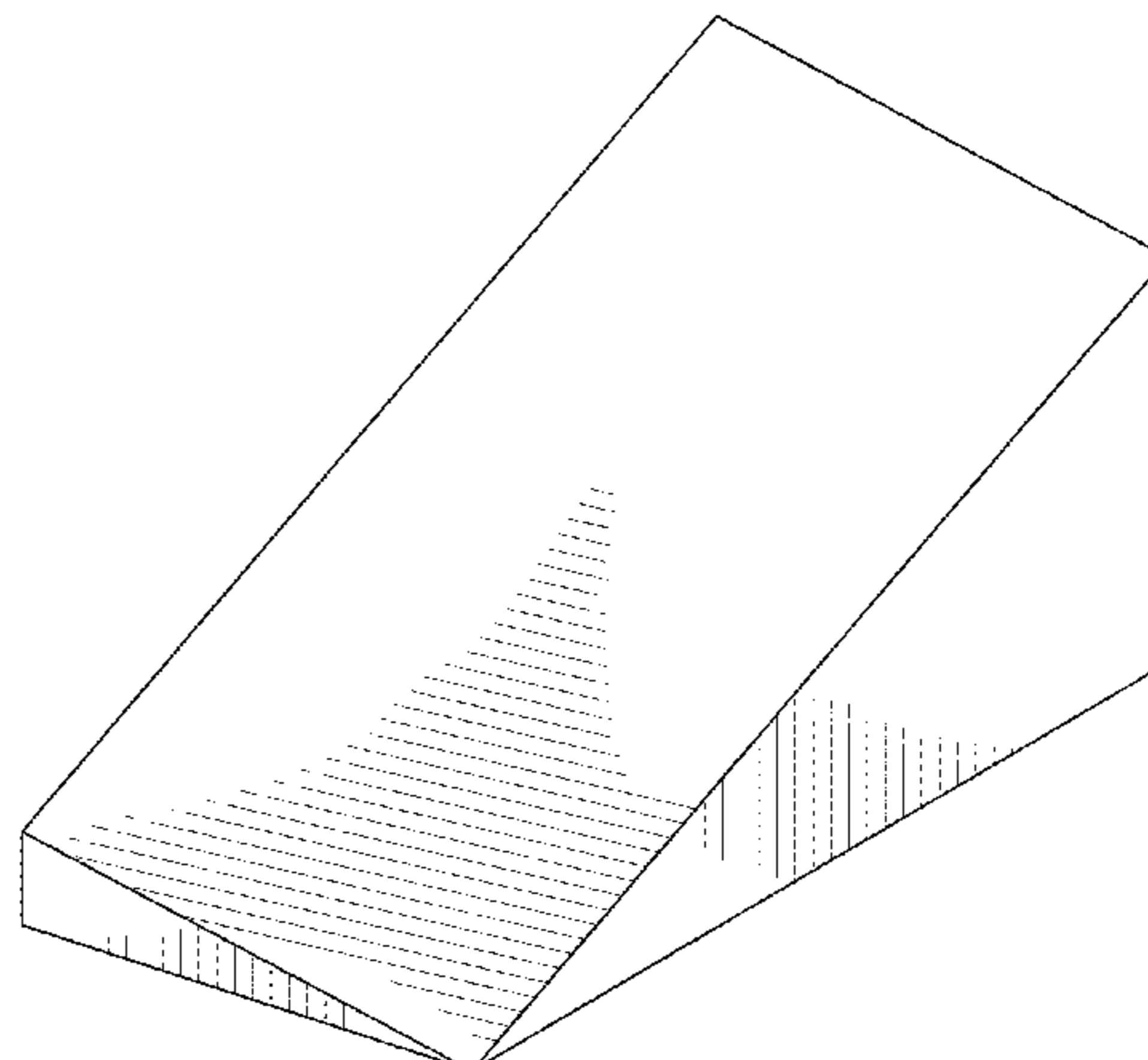
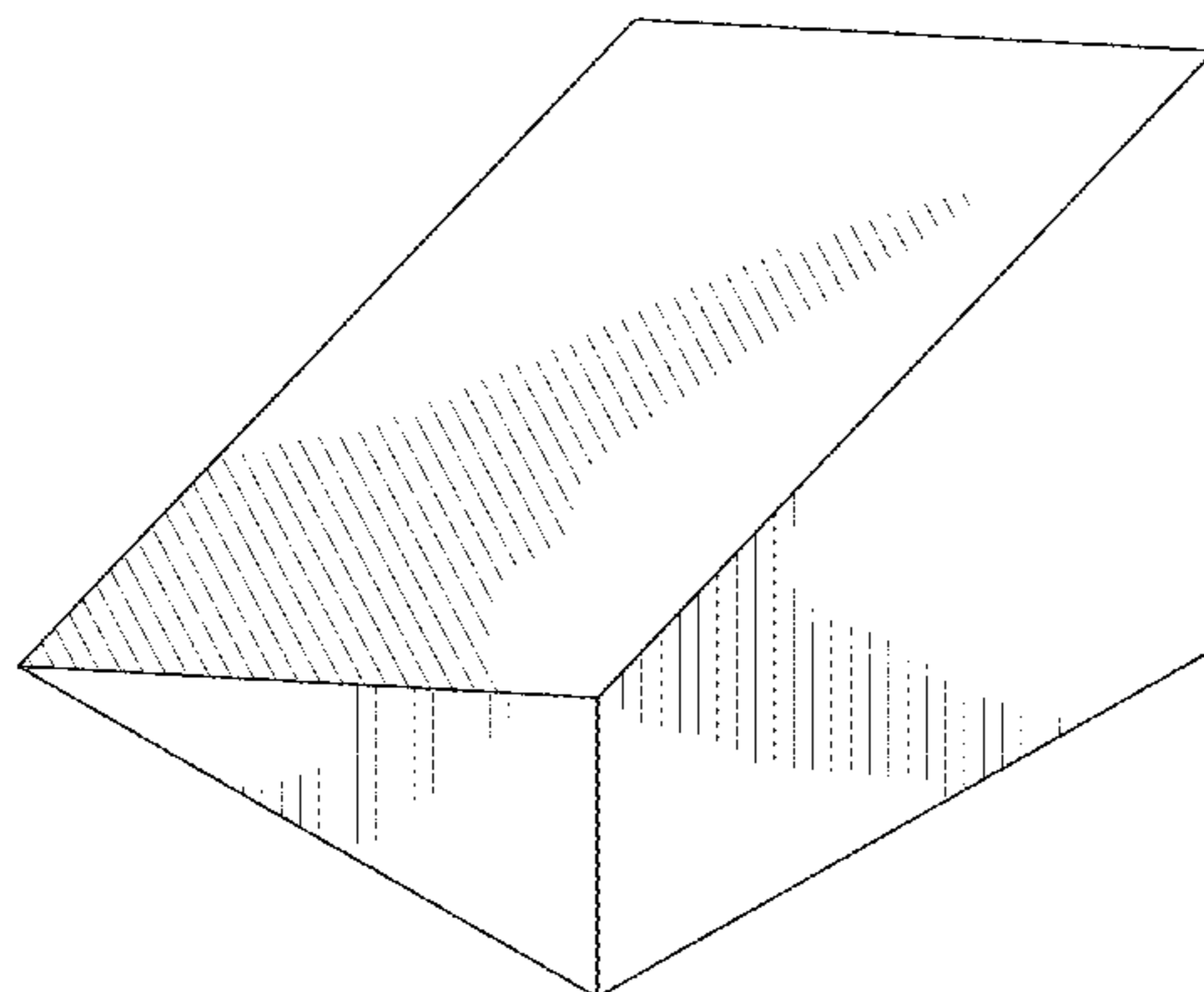

(56)

**References Cited**

U.S. PATENT DOCUMENTS

3,347,363 A 10/1967 Dykes et al.  
3,420,366 A \* 1/1969 Doyle ..... 206/436  
3,648,319 A 3/1972 Mitchell  
3,923,238 A \* 12/1975 Thomas ..... 229/198.2  
5,486,393 A \* 1/1996 Wiklund ..... 428/58  
D393,062 S \* 3/1998 Scheuer et al. .... D23/366  
D432,011 S 10/2000 Millon

D453,598 S 2/2002 Fagg et al.  
6,735,809 B2 5/2004 Parks  
D551,967 S \* 10/2007 Hengami ..... D9/431  
D552,633 S 10/2007 Volkan  
D575,189 S 8/2008 Fortin et al.  
D641,527 S 7/2011 Regnier et al.  
D644,101 S 8/2011 Caldwell et al.  
8,408,419 B2 4/2013 Rippl et al.  
D701,016 S \* 3/2014 Rupp ..... D1/101

\* cited by examiner

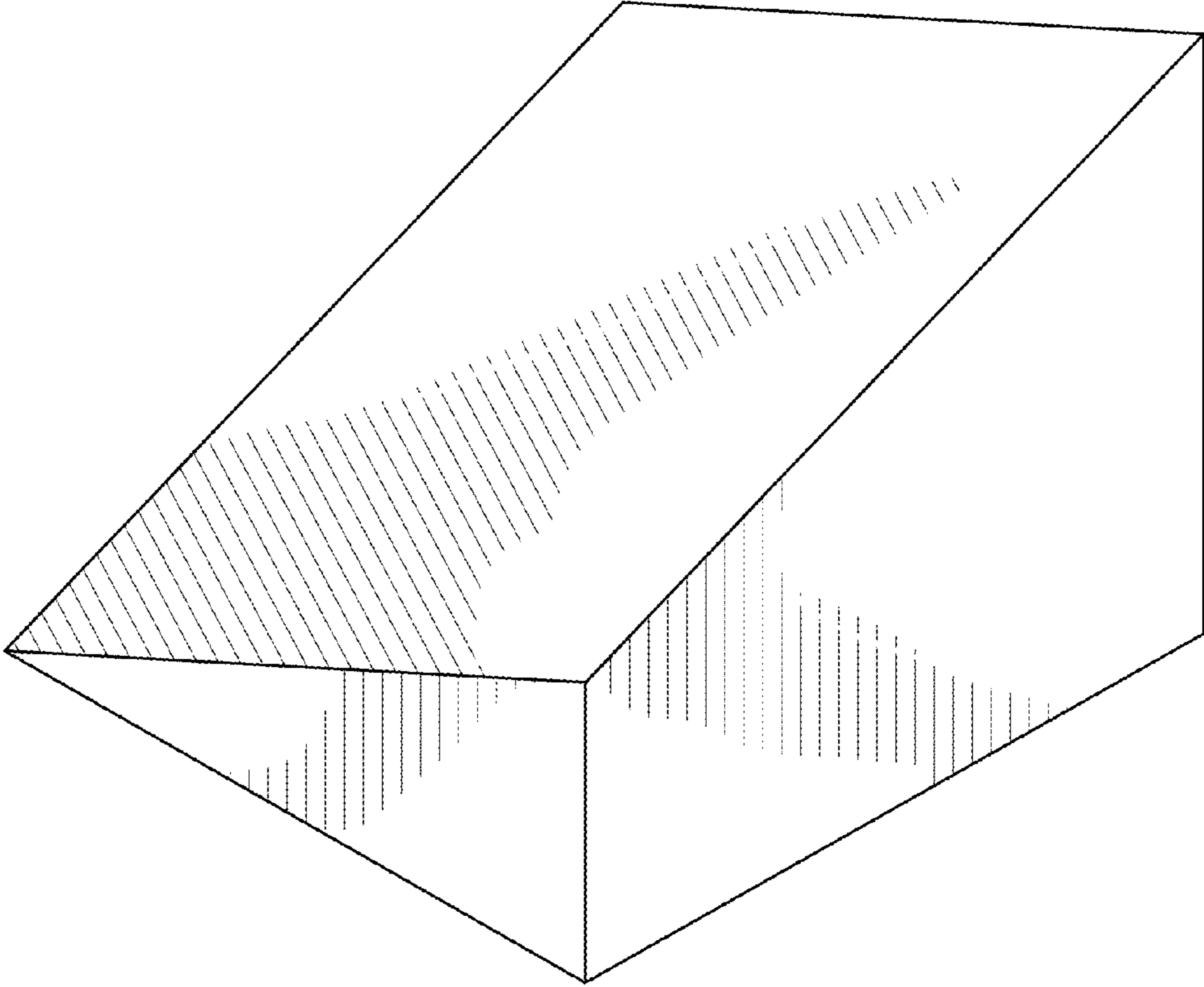
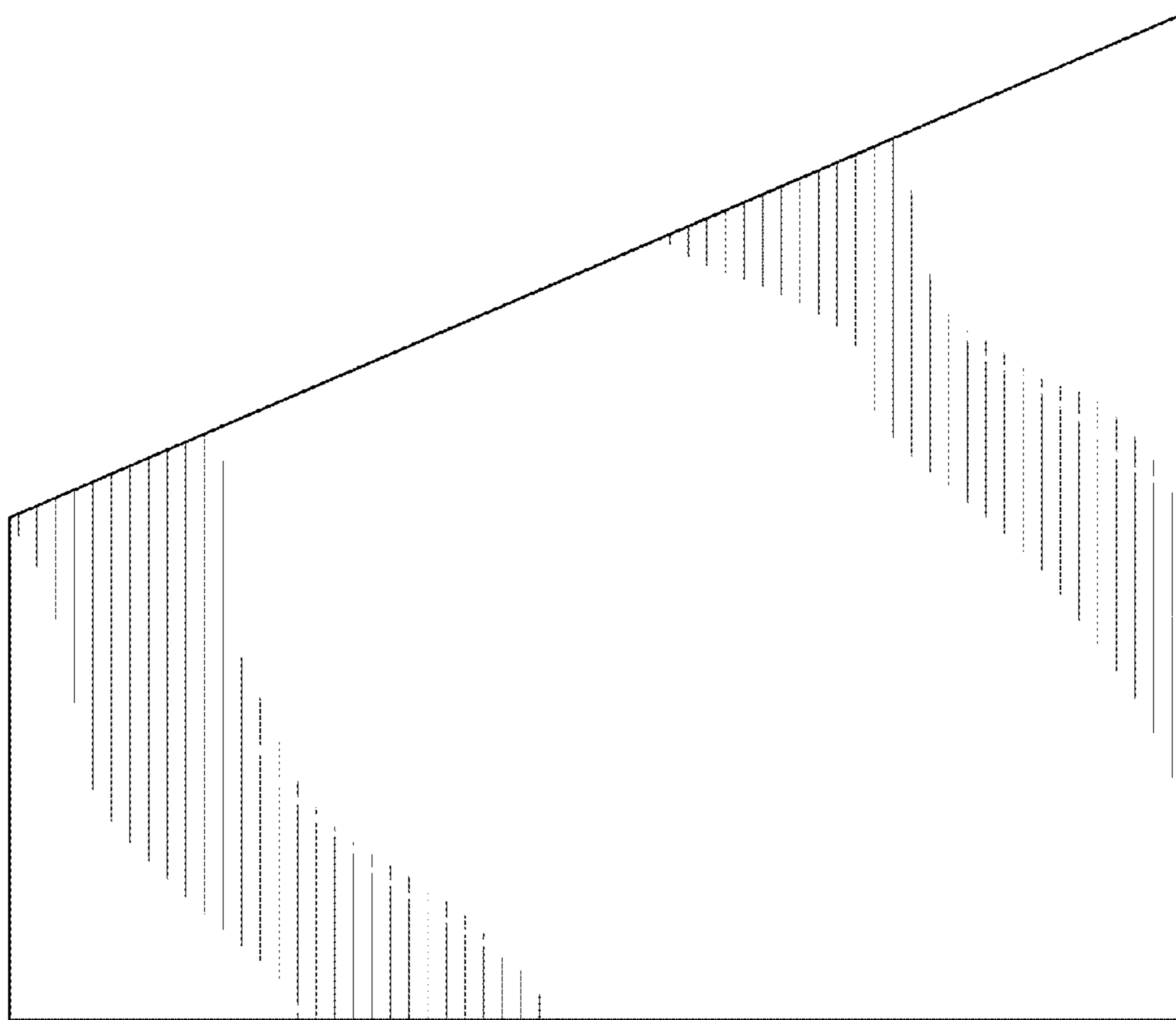

FIG. 1



**FIG. 2**

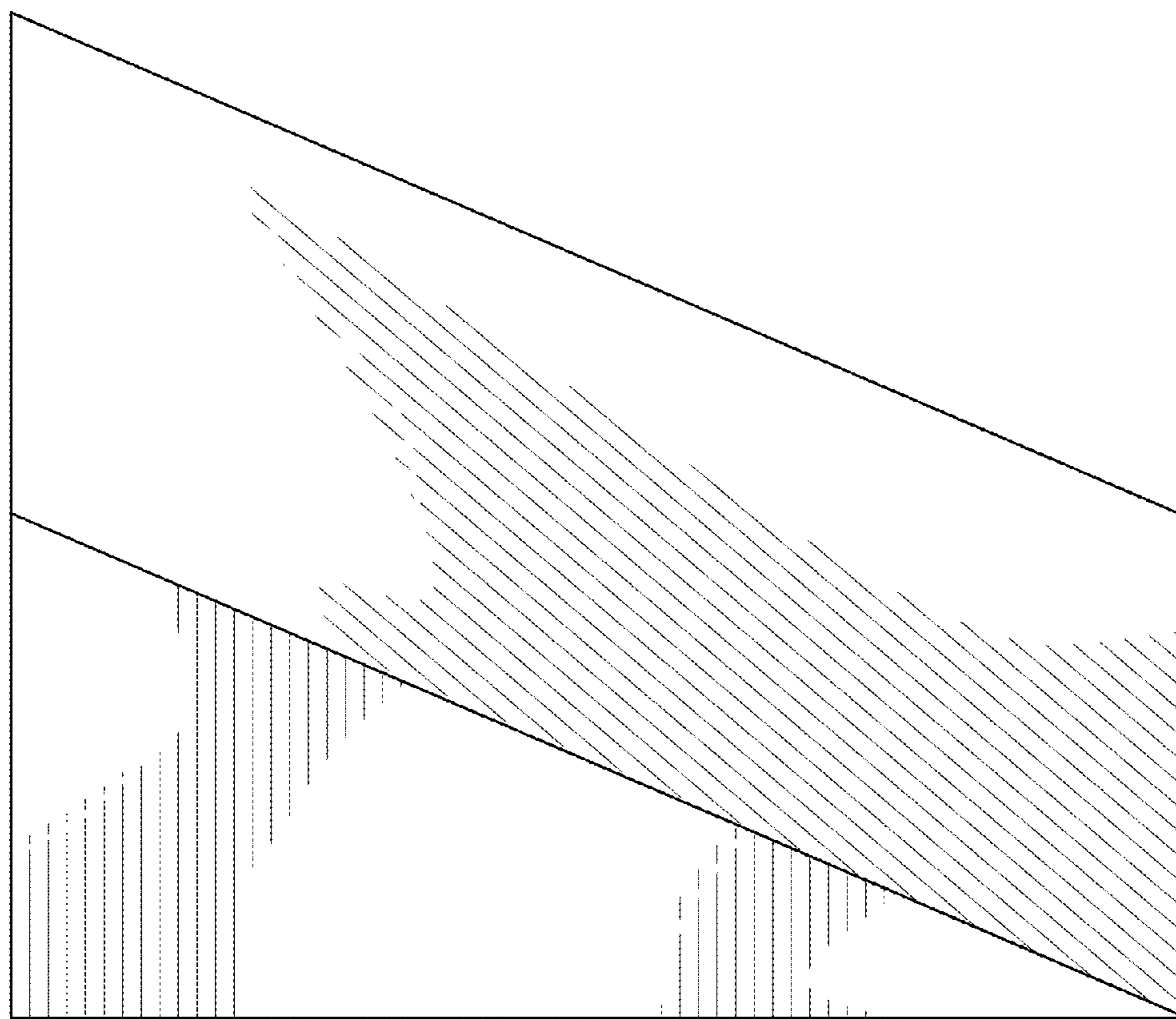

FIG. 3

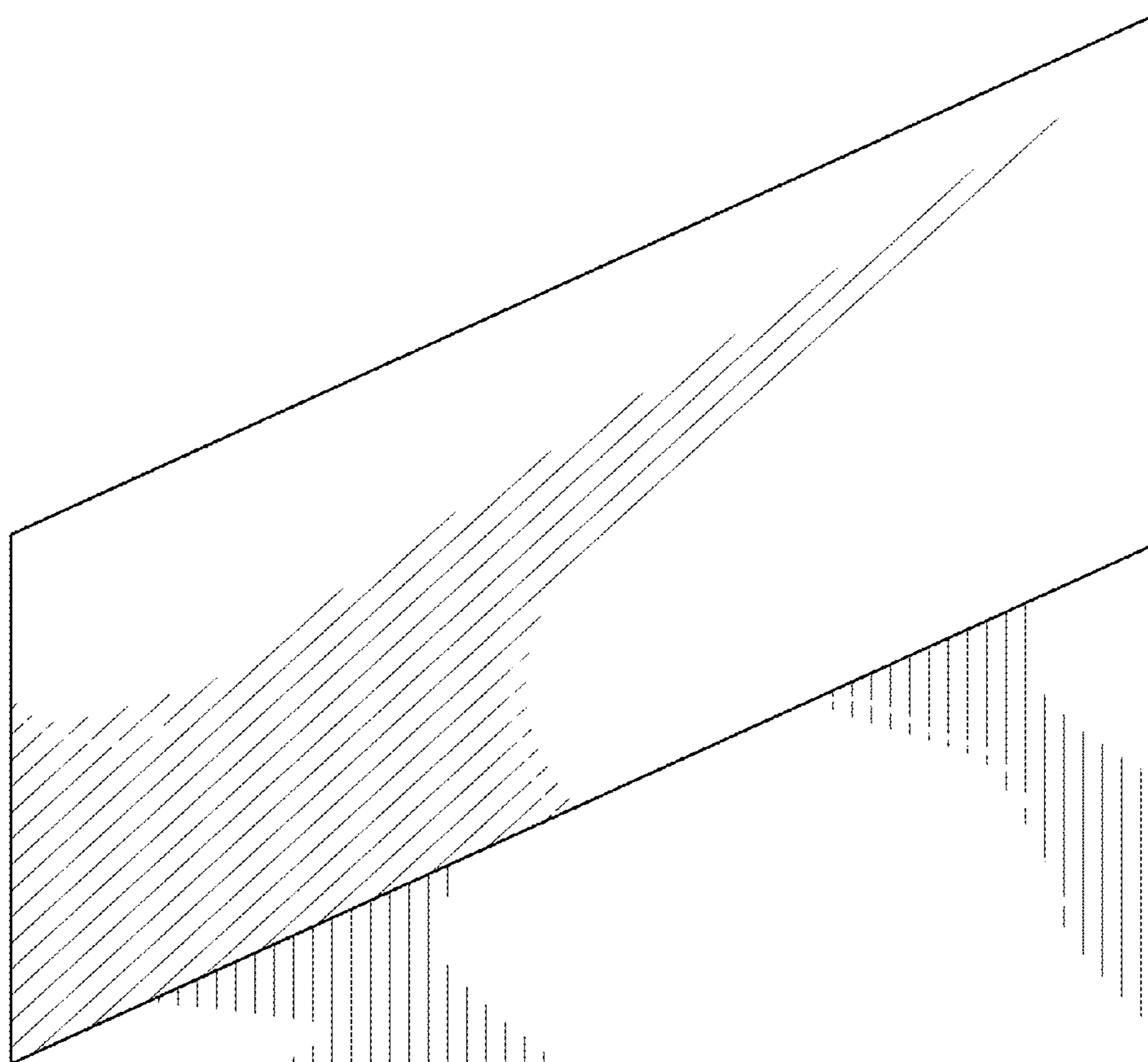
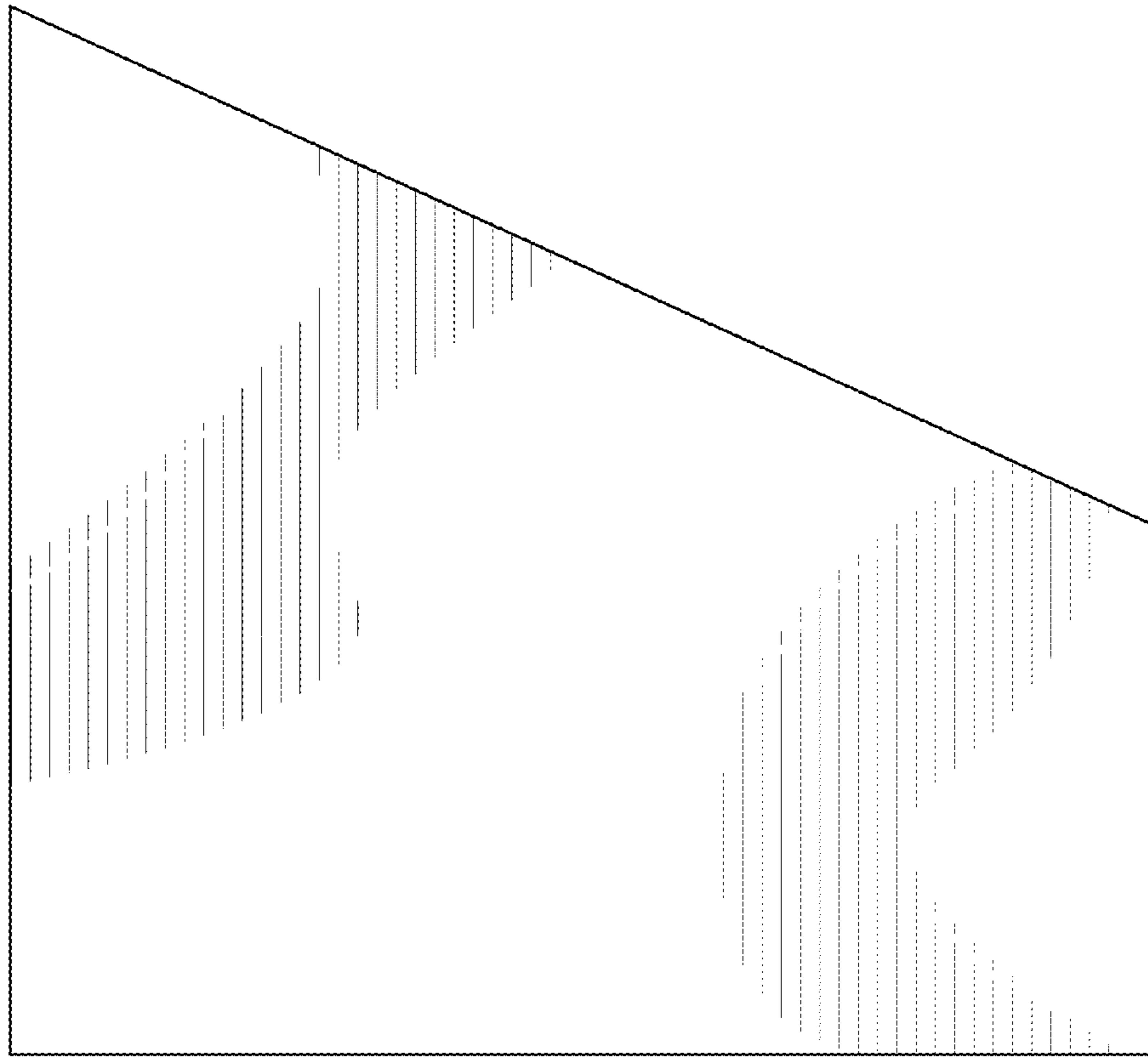

FIG. 4



*FIG. 5*

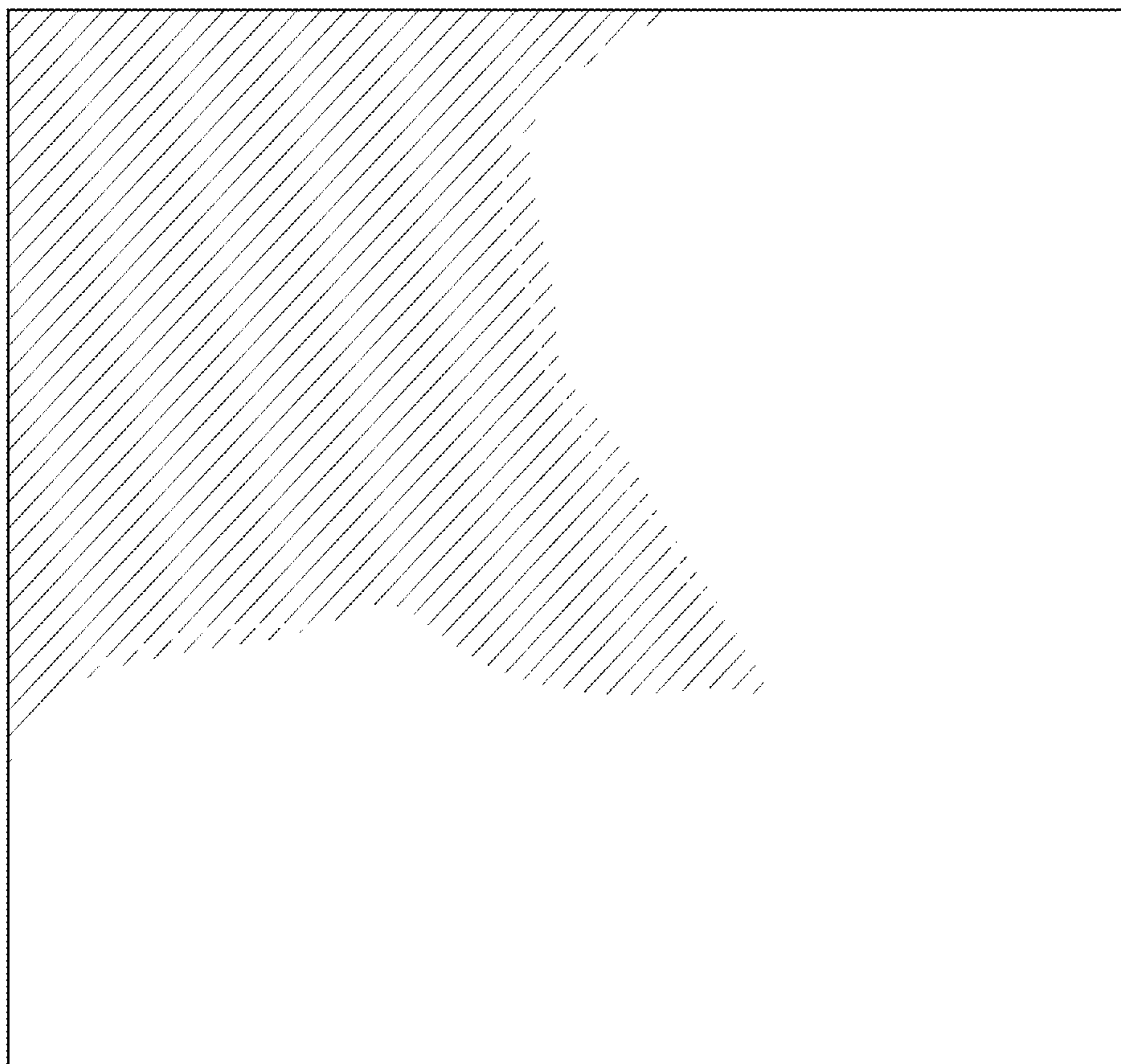

FIG. 6



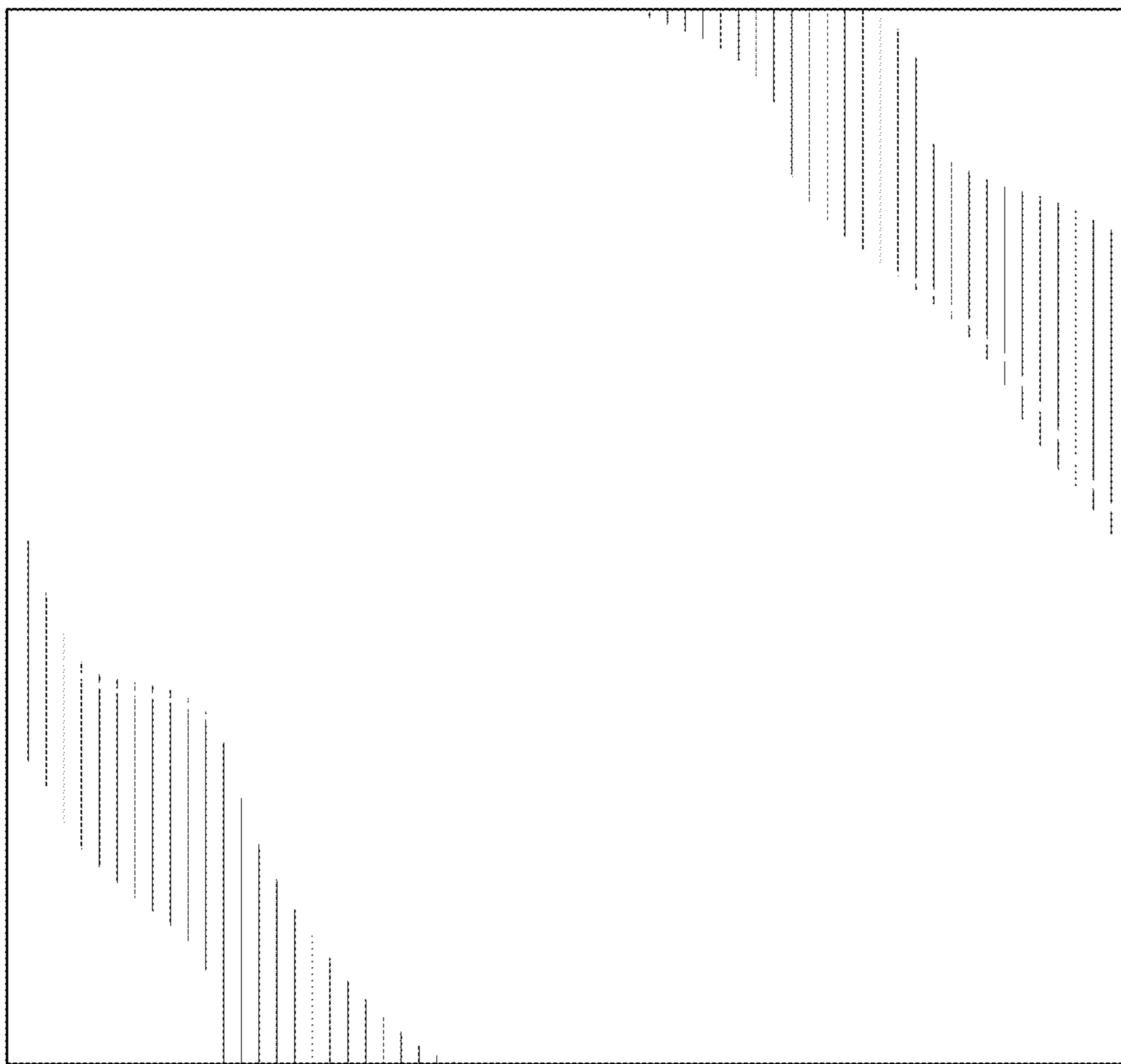
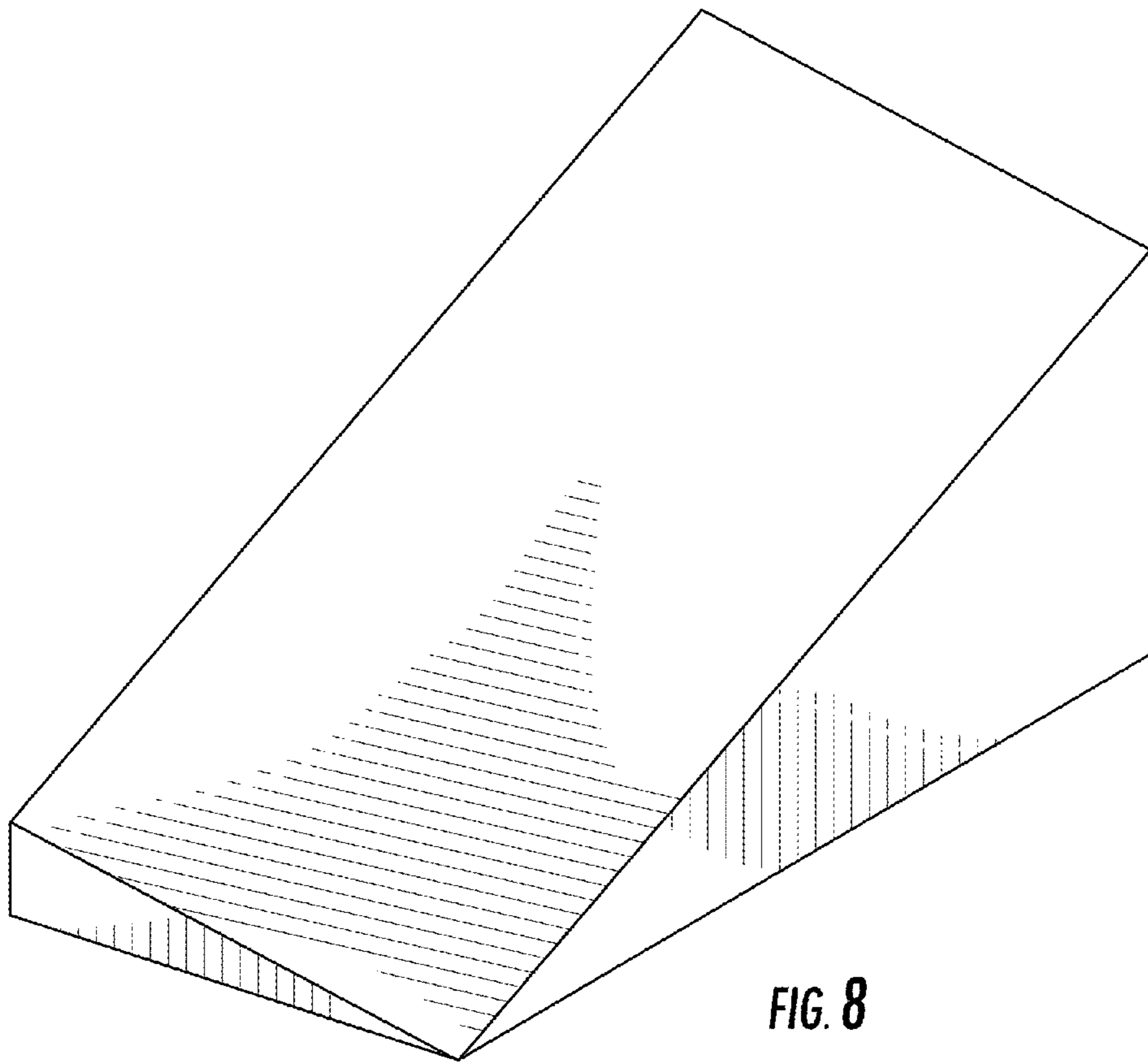
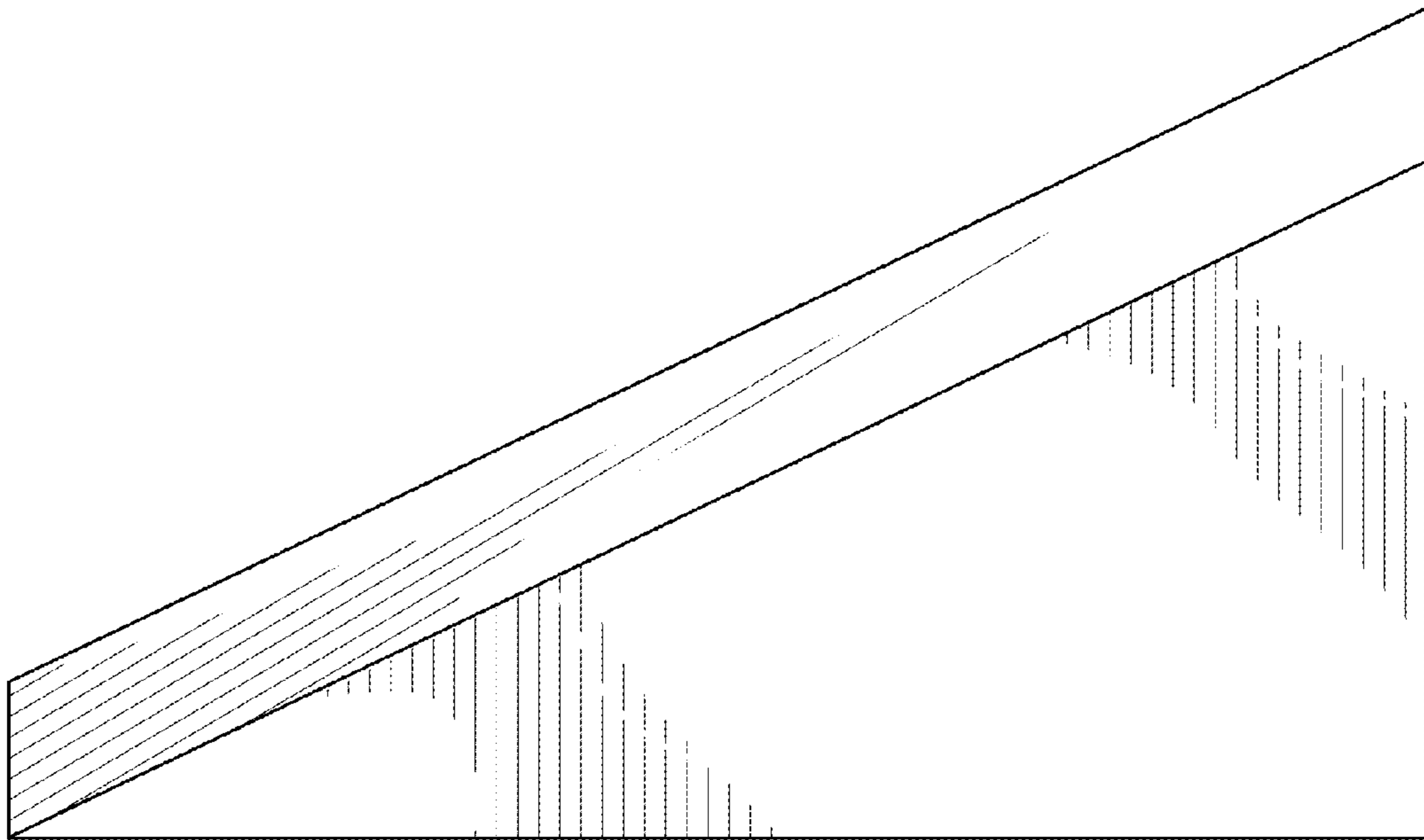
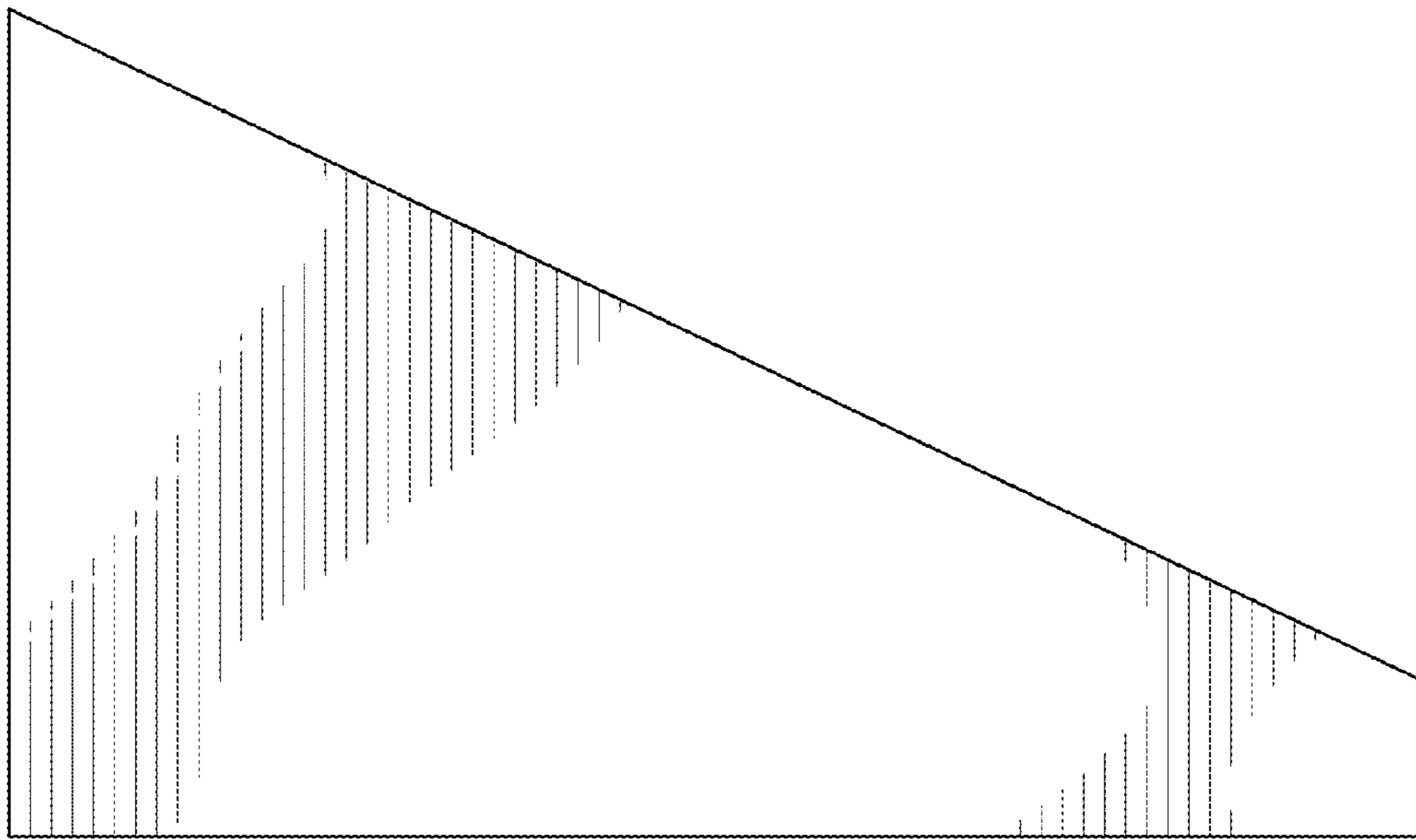

FIG. 7

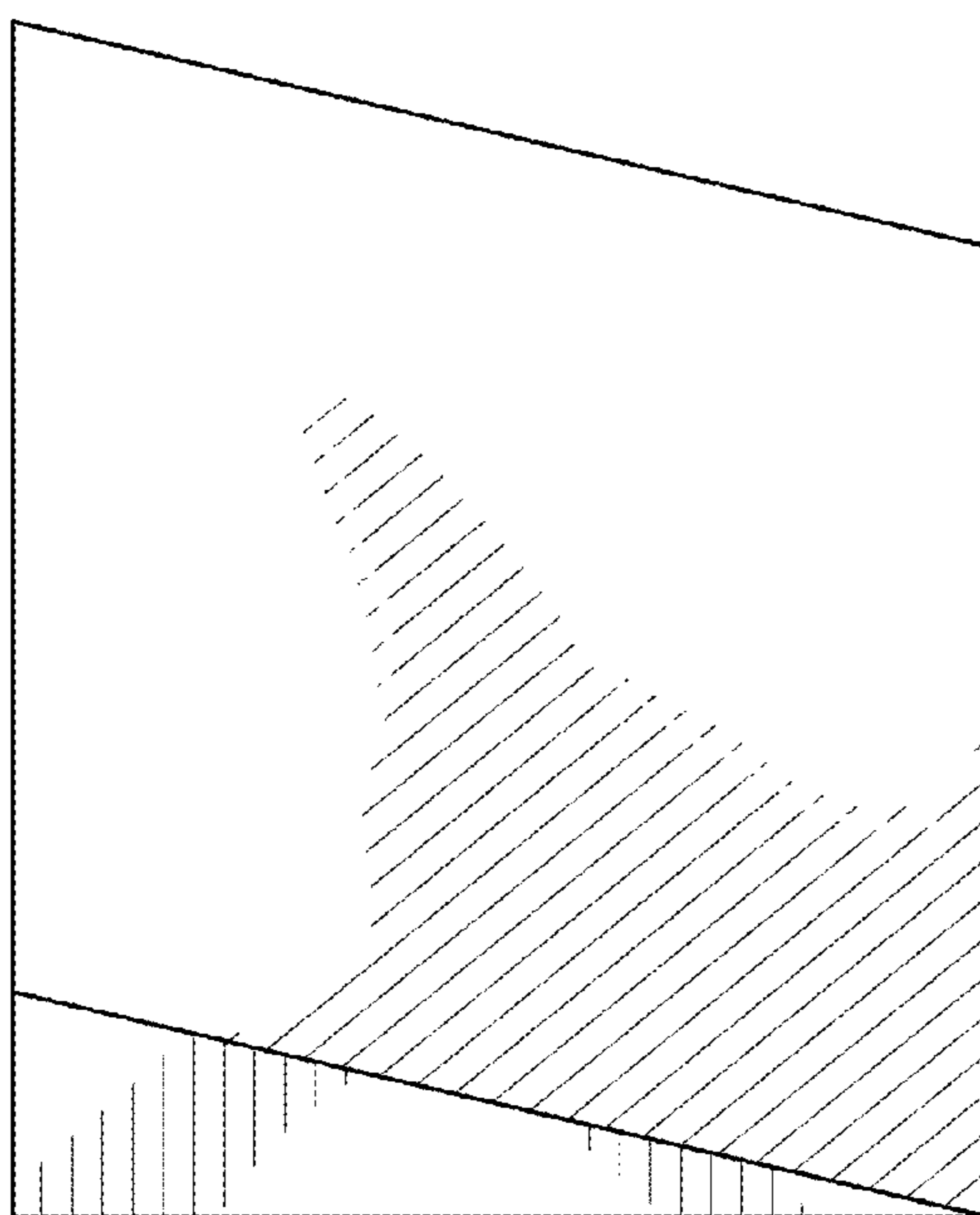



**FIG. 9**



**FIG. 10**



**FIG. 11**

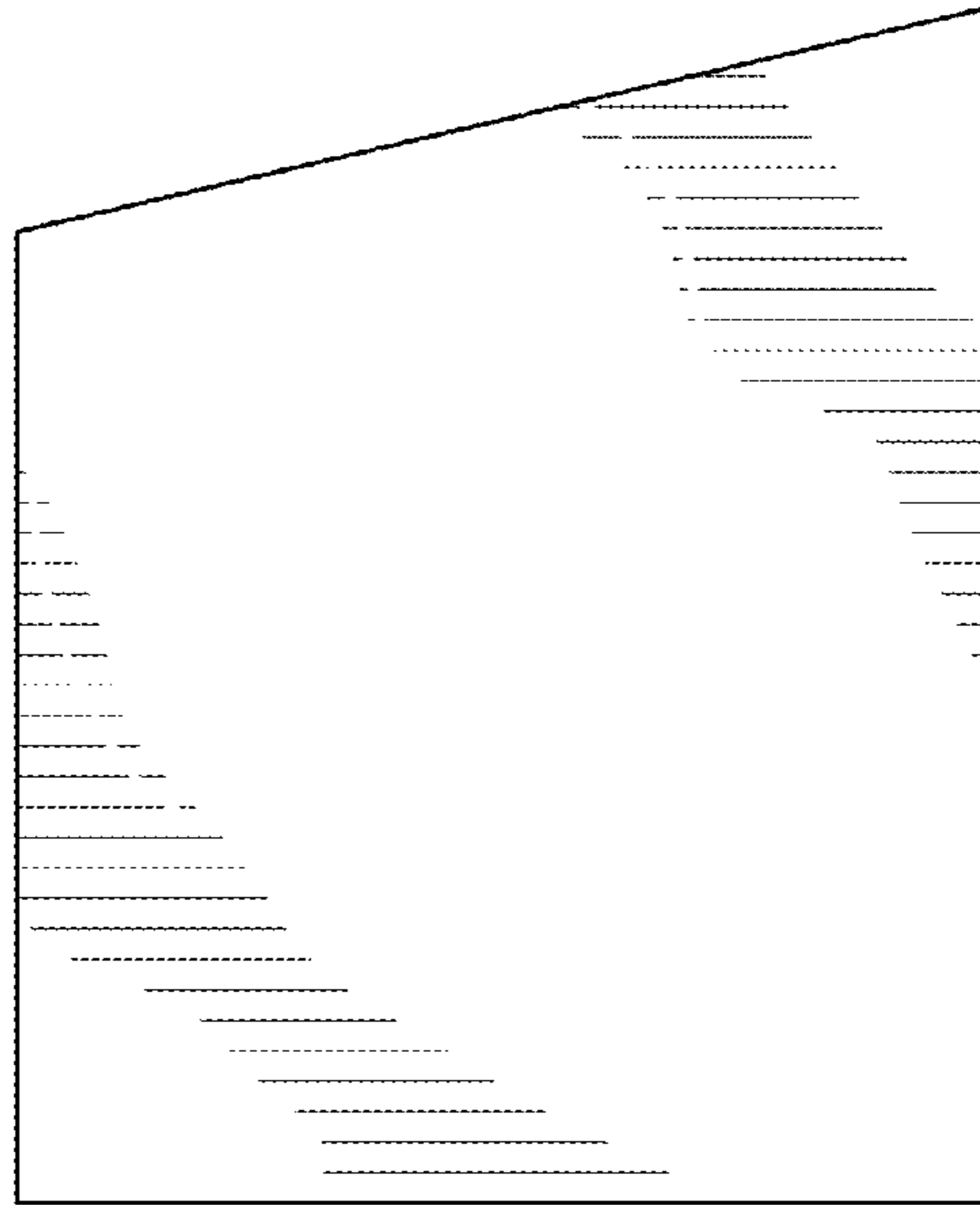

**FIG. 12**



**FIG. 13**

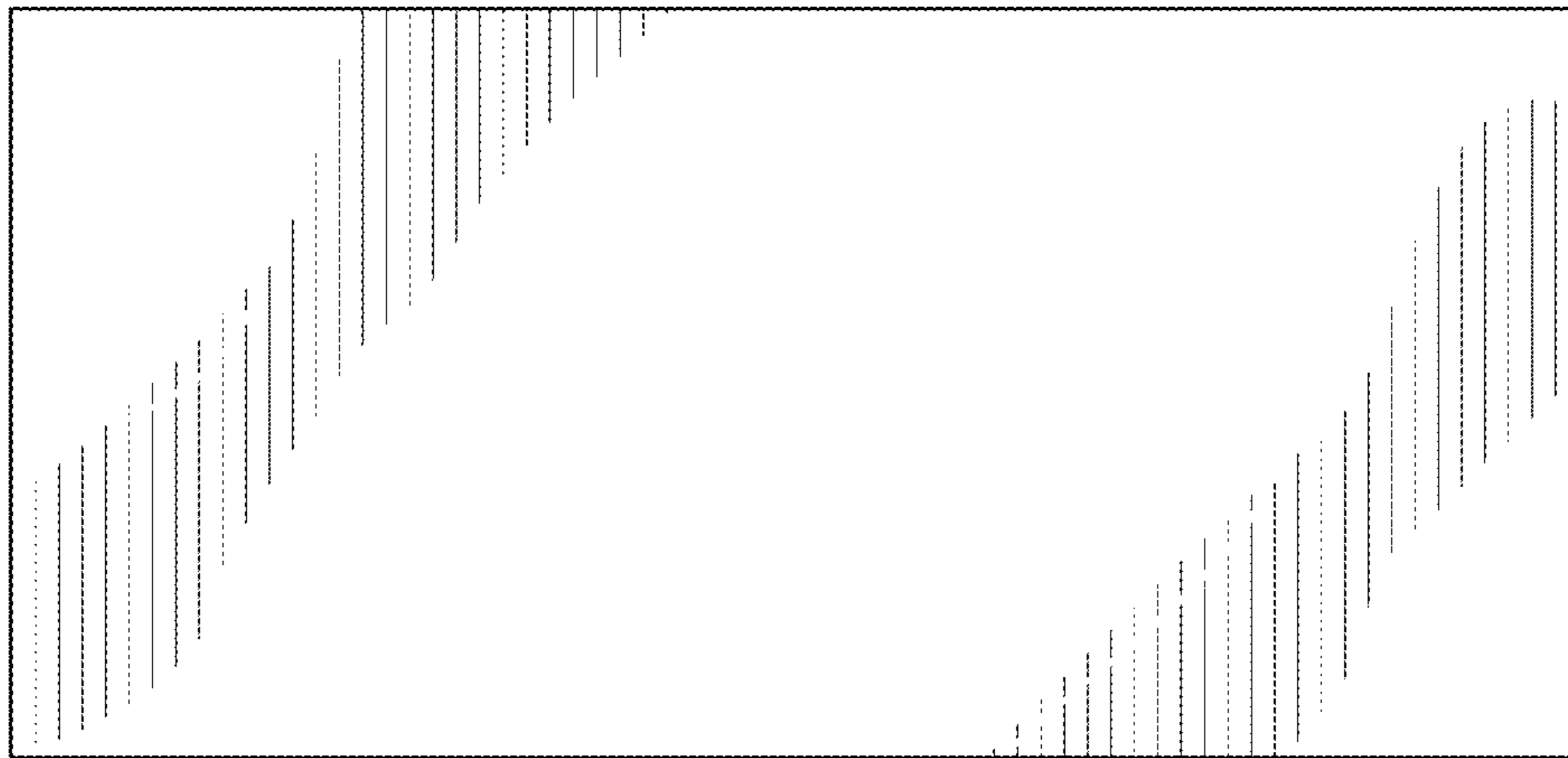

**FIG. 14**



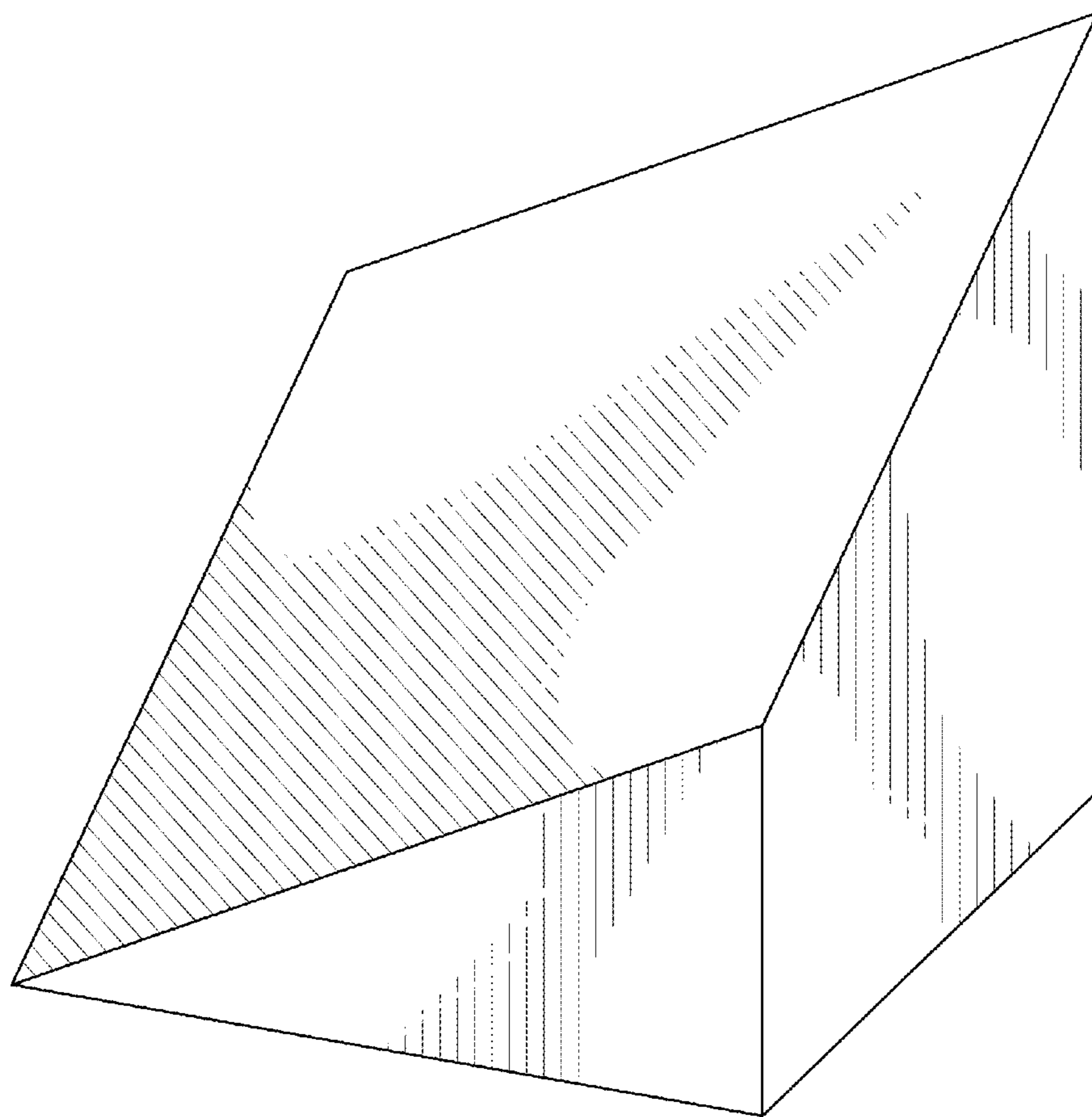
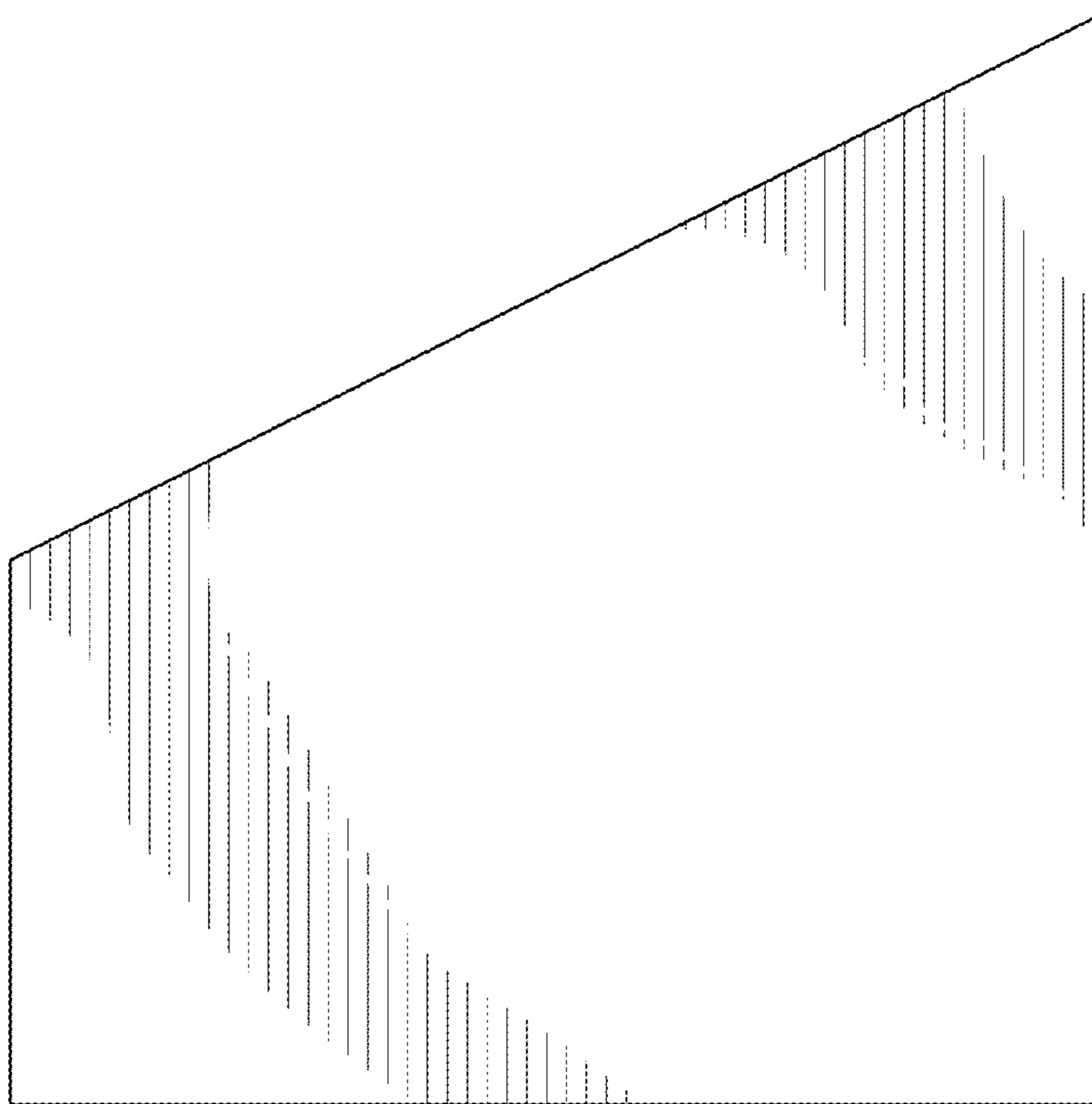

FIG. 15



**FIG. 16**

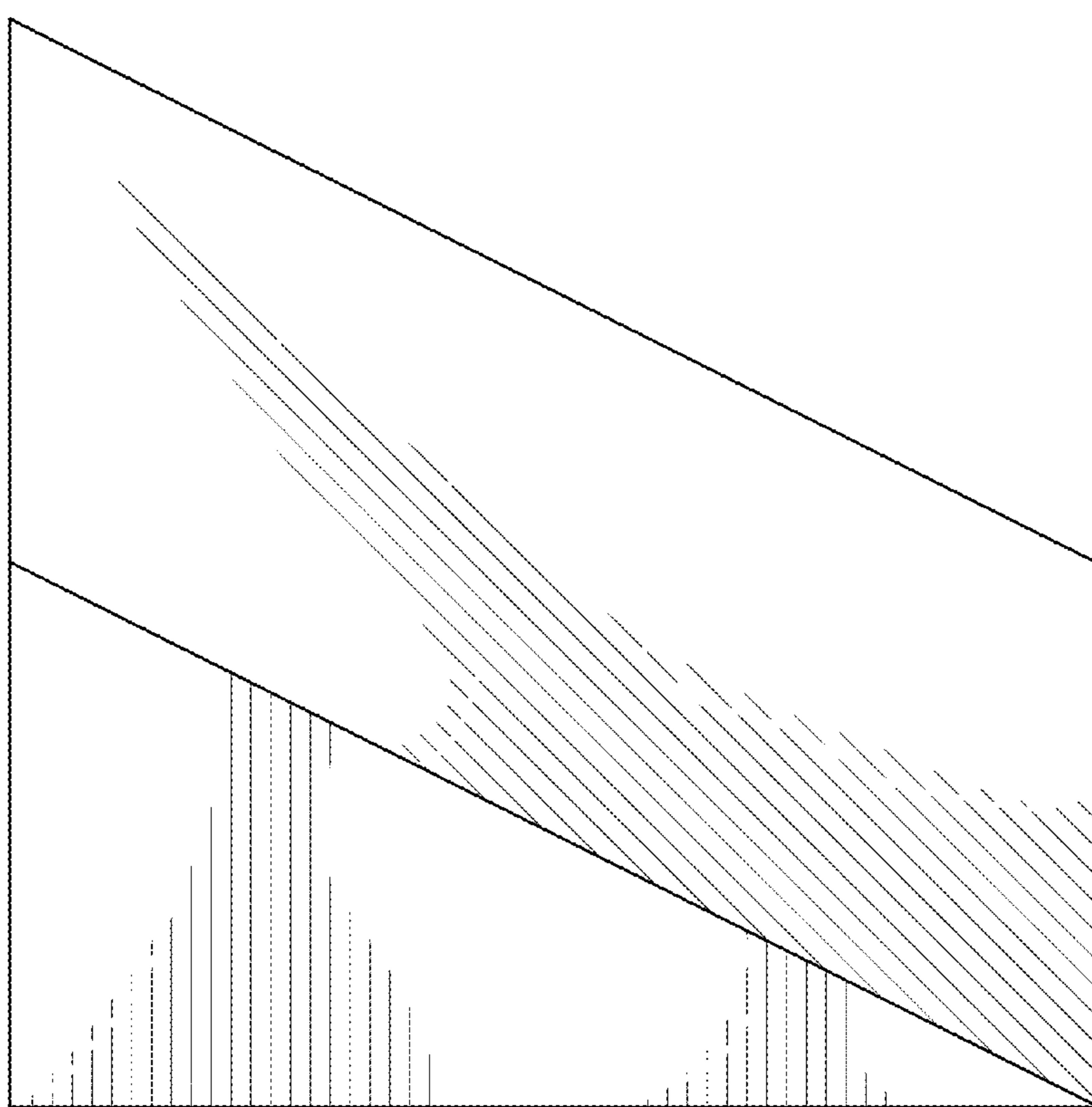
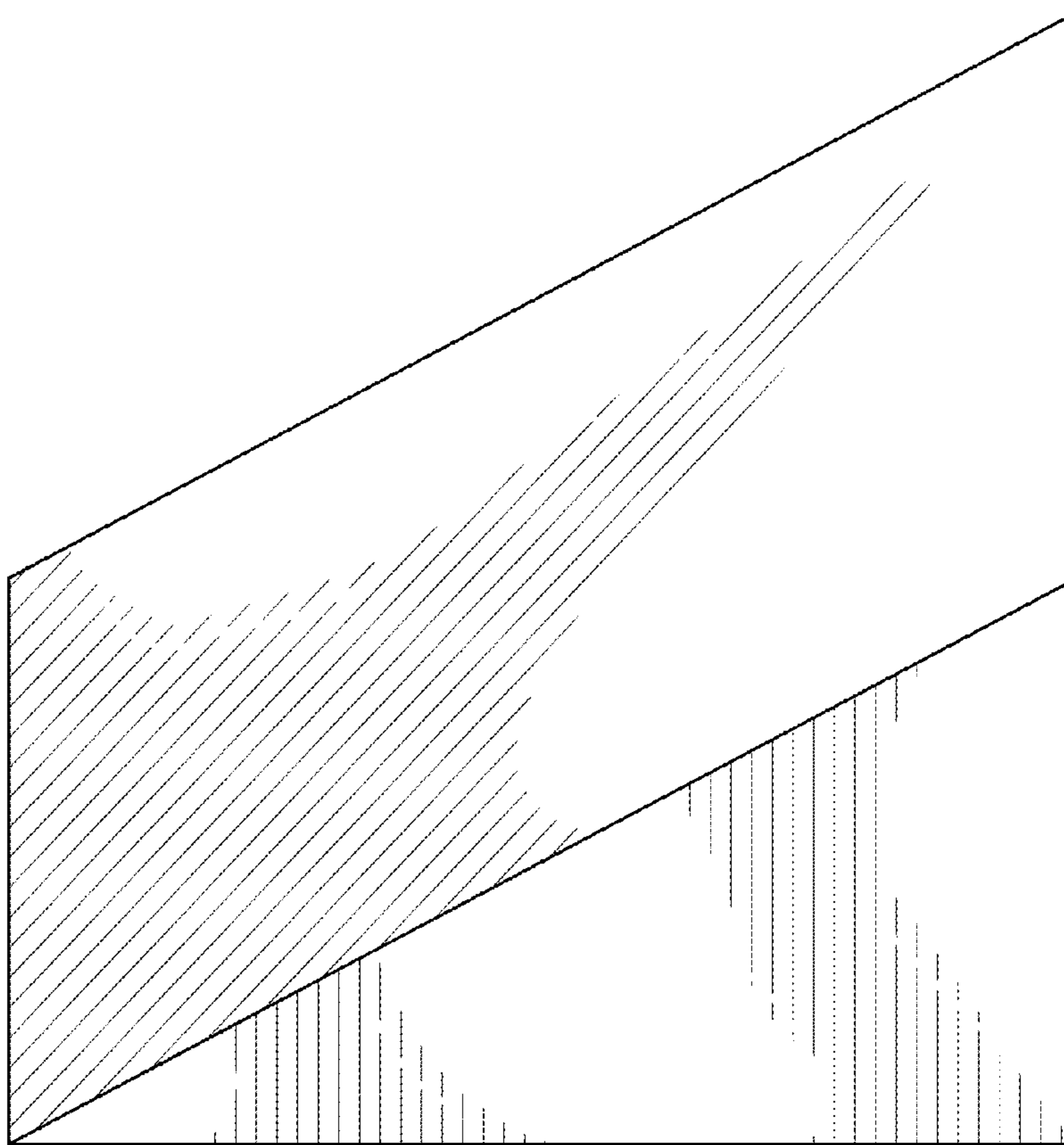
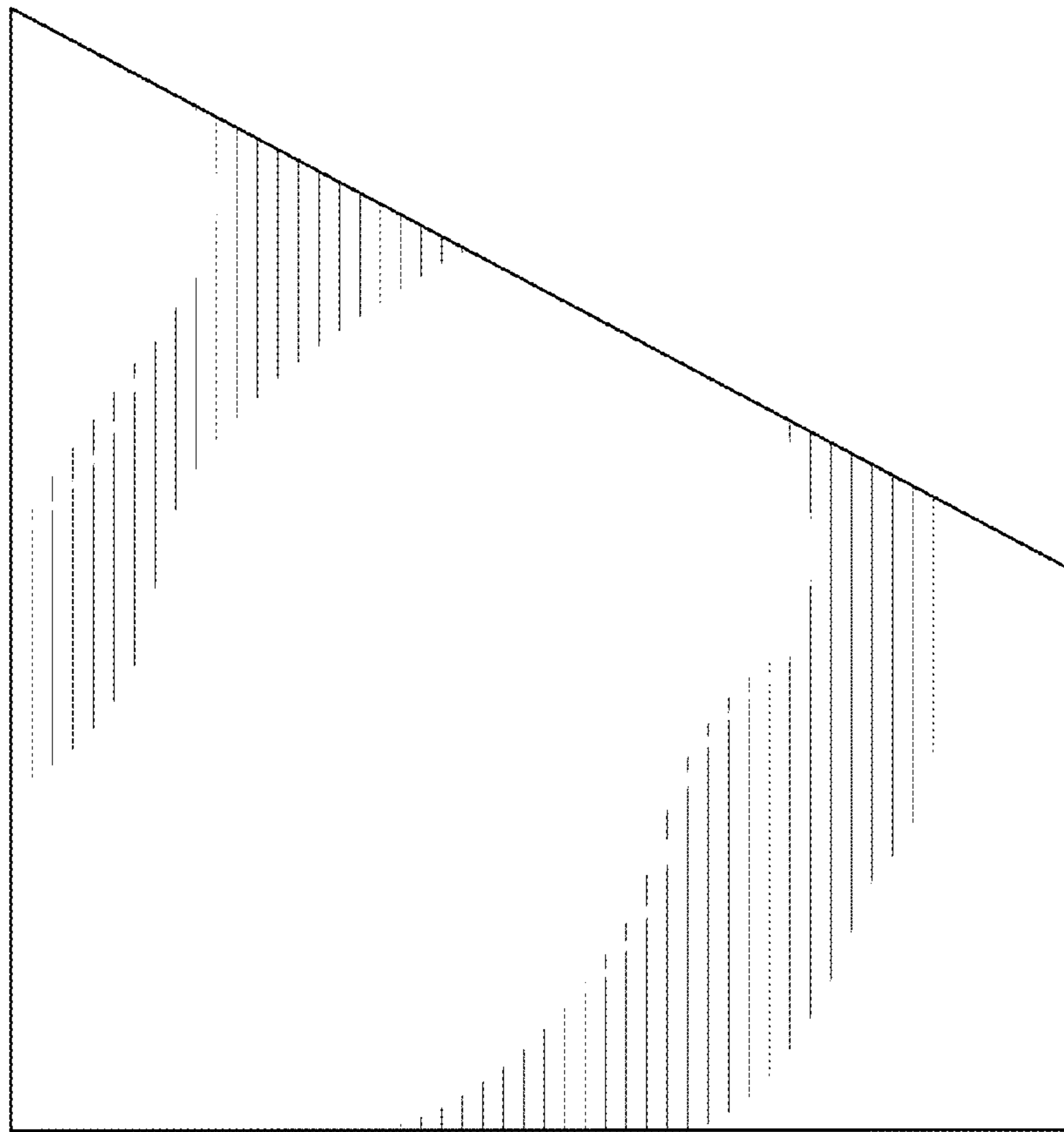

FIG. 17



**FIG. 18**



**FIG. 19**

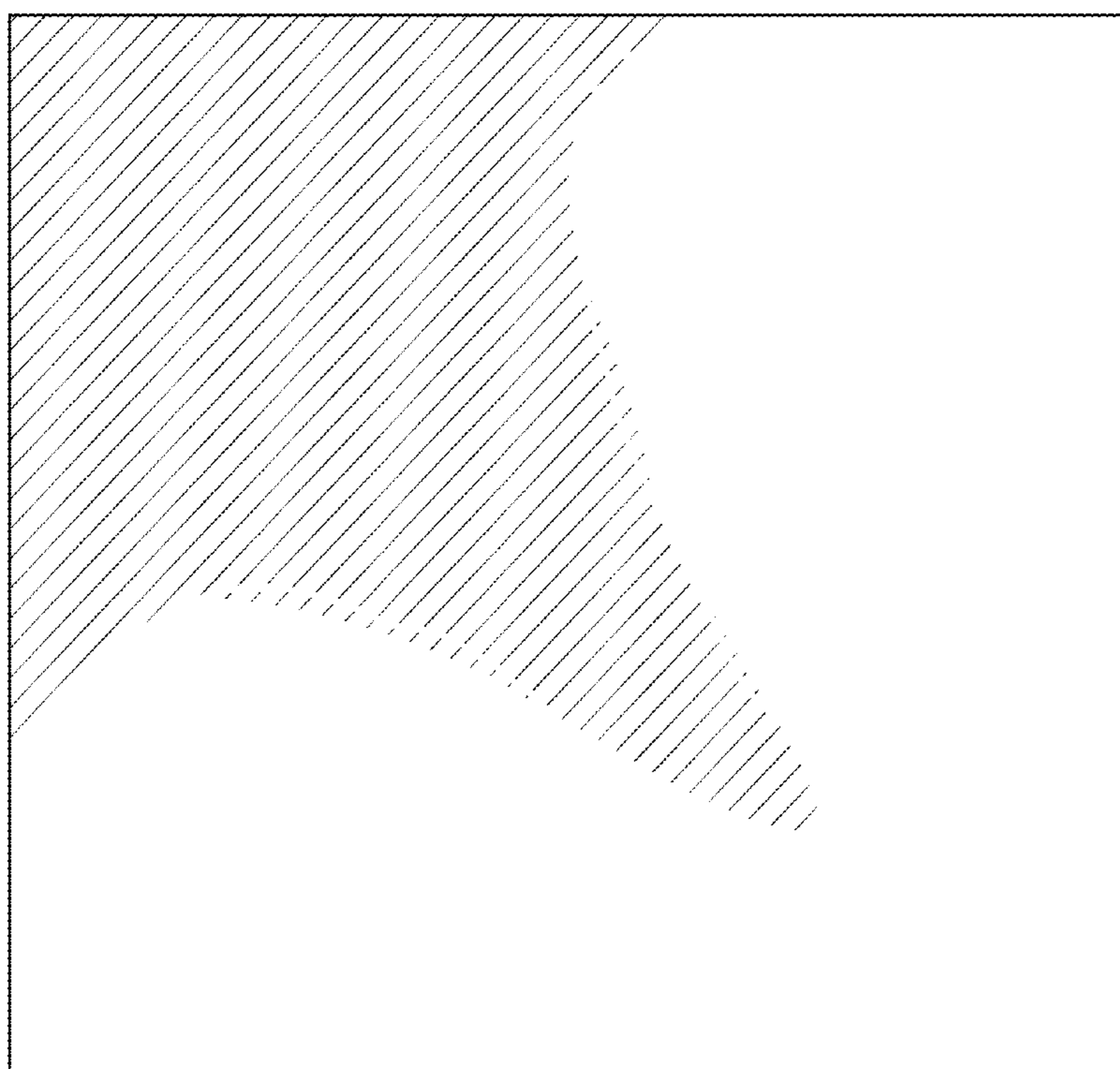

**FIG. 20**

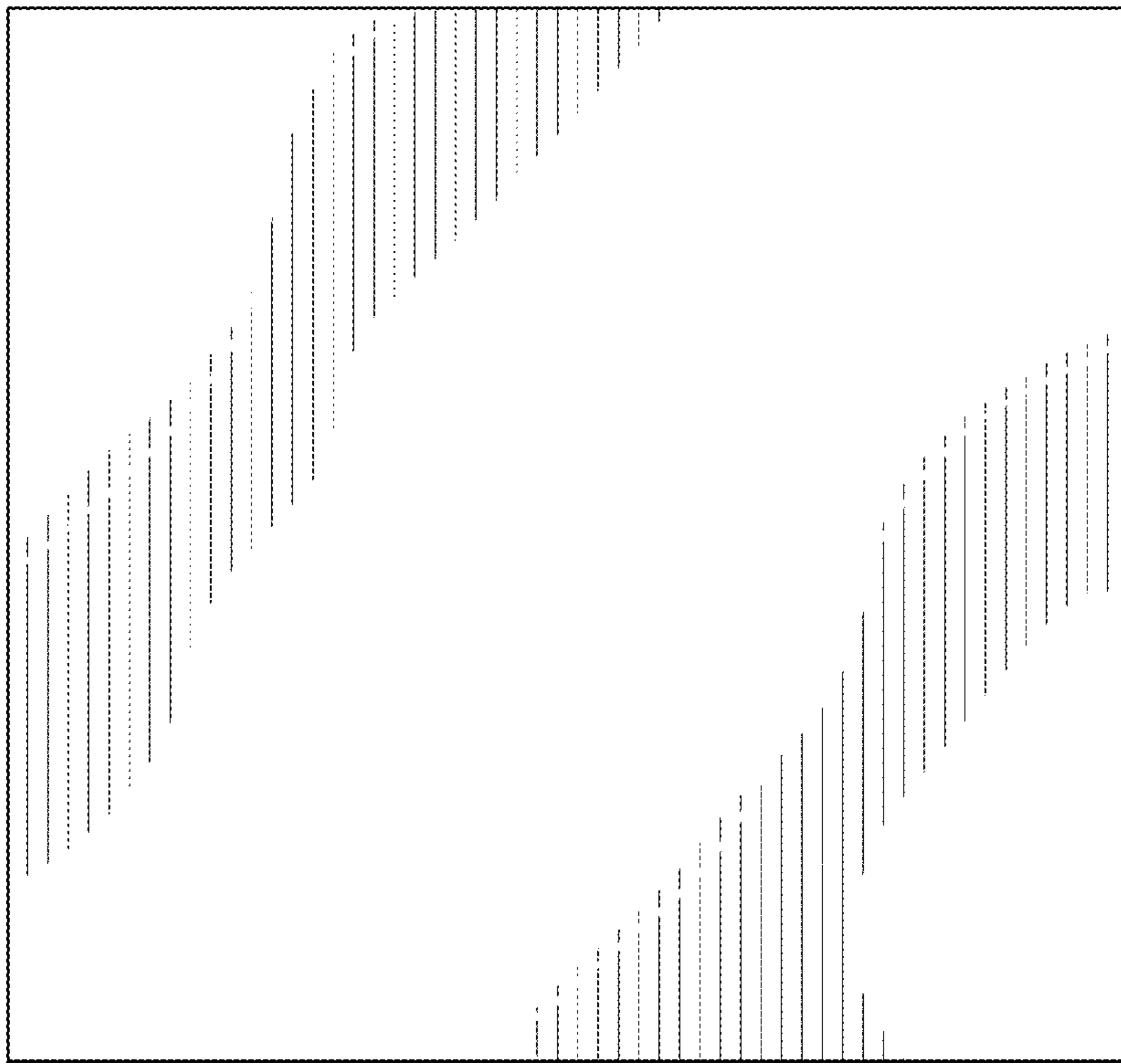

*FIG. 21*