



US00D711611S

(12) **United States Design Patent**
Dallaire

(10) **Patent No.:** **US D711,611 S**

(45) **Date of Patent:** **** Aug. 19, 2014**

- (54) **HELMET RETURNING BIN**
- (71) Applicant: **PBSC Solutions Urbaines Inc.,**
Longueuil (CA)
- (72) Inventor: **Michel Dallaire, Montreal (CA)**
- (73) Assignee: **PCSC Solutions Urbaines Inc.,**
Longueuil (CA)
- (**) Term: **14 Years**
- (21) Appl. No.: **29/455,863**
- (22) Filed: **May 24, 2013**
- (51) **LOC (10) Cl.** **09-09**
- (52) **U.S. Cl.**
USPC **D34/7**
- (58) **Field of Classification Search**
USPC D34/1-11; 220/908, 908.1, 911, 912,
220/913
See application file for complete search history.

- D597,721 S * 8/2009 Brockington et al. D34/7
- D616,171 S * 5/2010 Rizzi D34/7
- D641,119 S * 7/2011 Rampton et al. D34/1
- D652,599 S * 1/2012 Kane D34/1
- D672,109 S * 12/2012 Moore D34/6
- D684,332 S * 6/2013 Gollob D34/1
- D696,482 S * 12/2013 Nelson D34/1

* cited by examiner

Primary Examiner — Cynthia Ramirez

(74) *Attorney, Agent, or Firm* — Robic, LLP

(57) **CLAIM**

The ornamental design for a helmet returning bin, as shown and described.

DESCRIPTION

FIG. 1 is a front, right, perspective view of a helmet returning bin showing my new design invention;
 FIG. 2 is a rear, left, perspective view thereof;
 FIG. 3 is a front elevation view thereof;
 FIG. 4 is a rear elevation view thereof;
 FIG. 5 is a left side elevation view thereof;
 FIG. 6 is a right side elevation view thereof;
 FIG. 7 is a top plan view thereof;
 FIG. 8 is a bottom plan view thereof; and,
 FIG. 9 is a front, right, perspective view of the helmet returning bin mounted on an elongated support base.
 The broken lines in the figures are included for the purpose of illustrating environment and form no part of the claimed design.

1 Claim, 8 Drawing Sheets

(56) **References Cited**

U.S. PATENT DOCUMENTS

- D216,739 S * 3/1970 Marsh D34/8
- D236,375 S * 8/1975 Moriconi et al. D15/123
- D322,703 S * 12/1991 Dosunmu D34/7
- D326,344 S * 5/1992 Fitermann et al. D34/11
- 5,242,220 A * 9/1993 Sandreth 312/311
- D422,753 S * 4/2000 Einarson D28/77

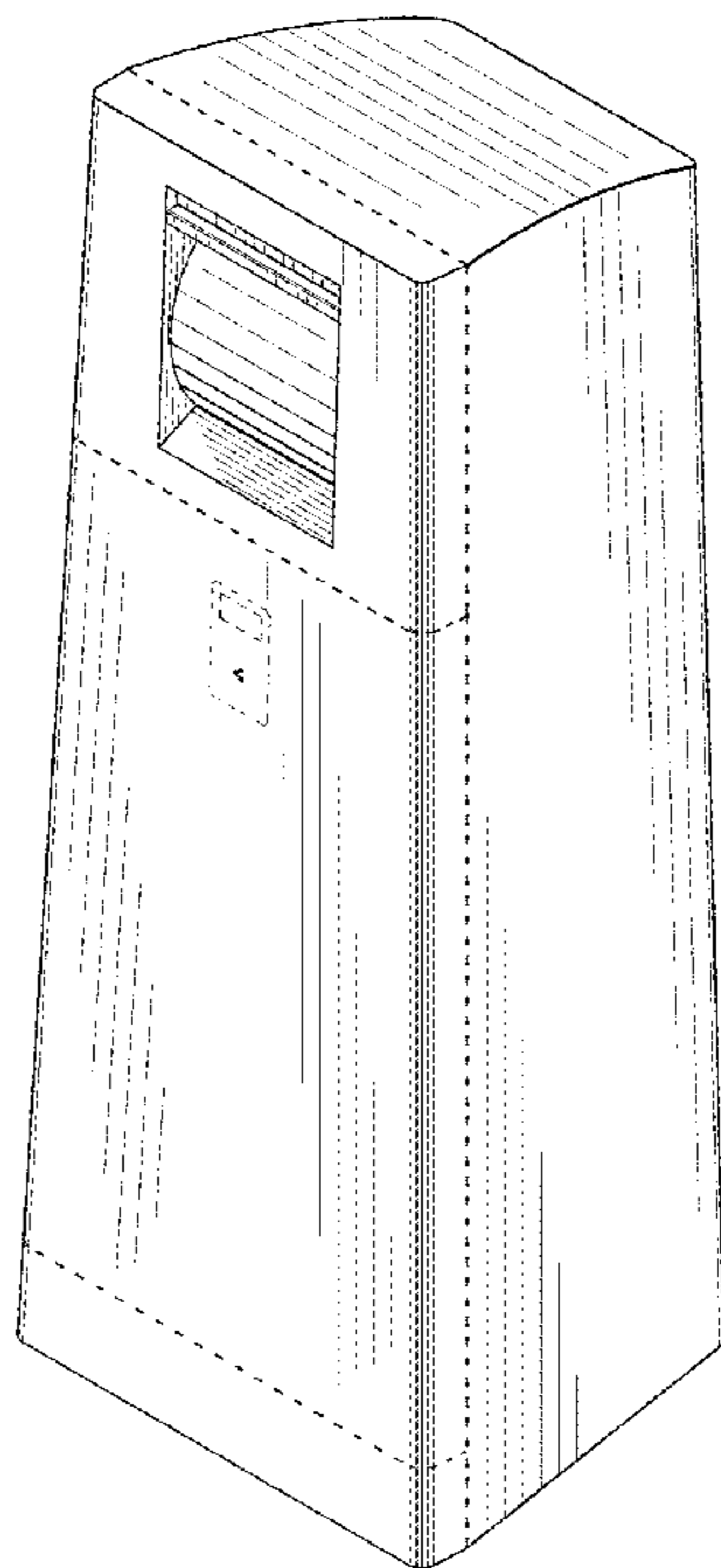

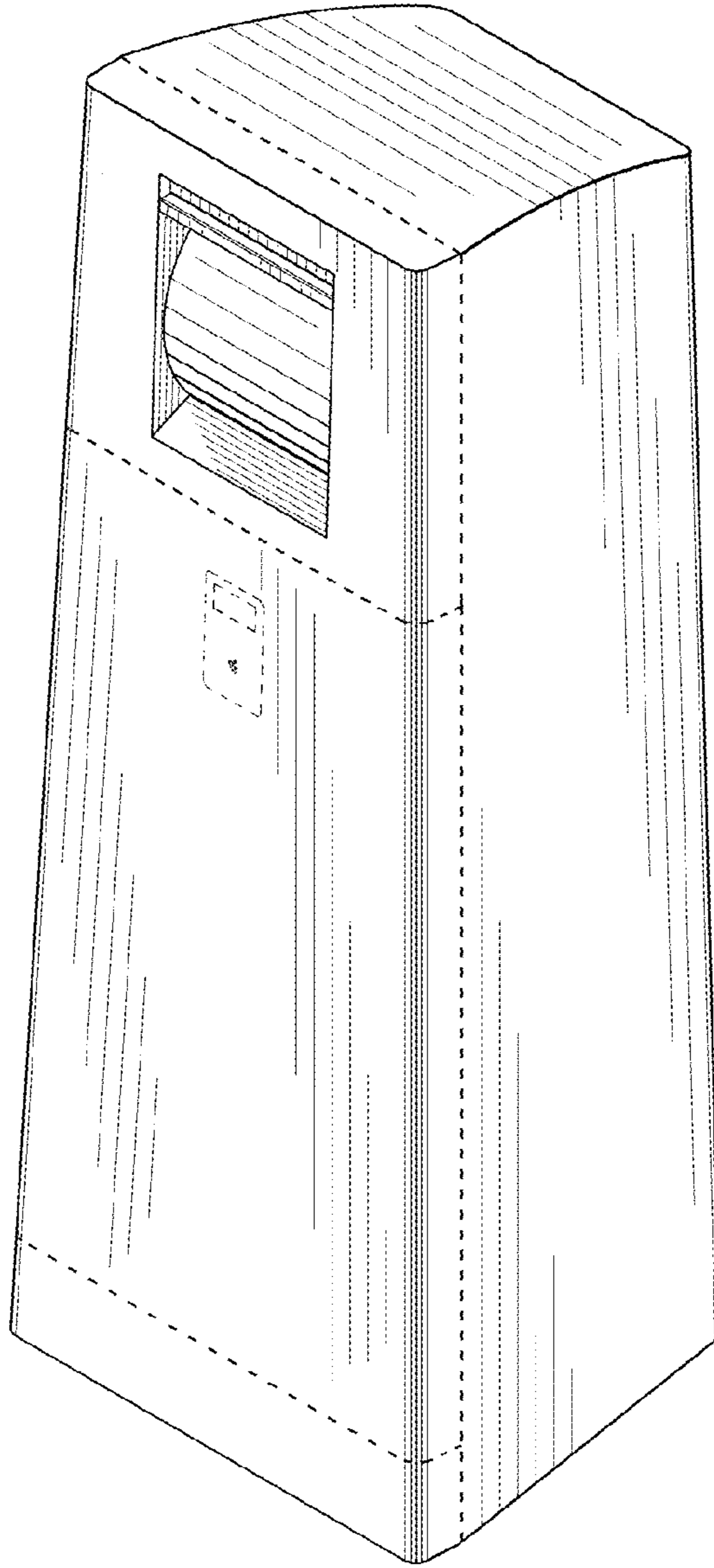

FIG. 1

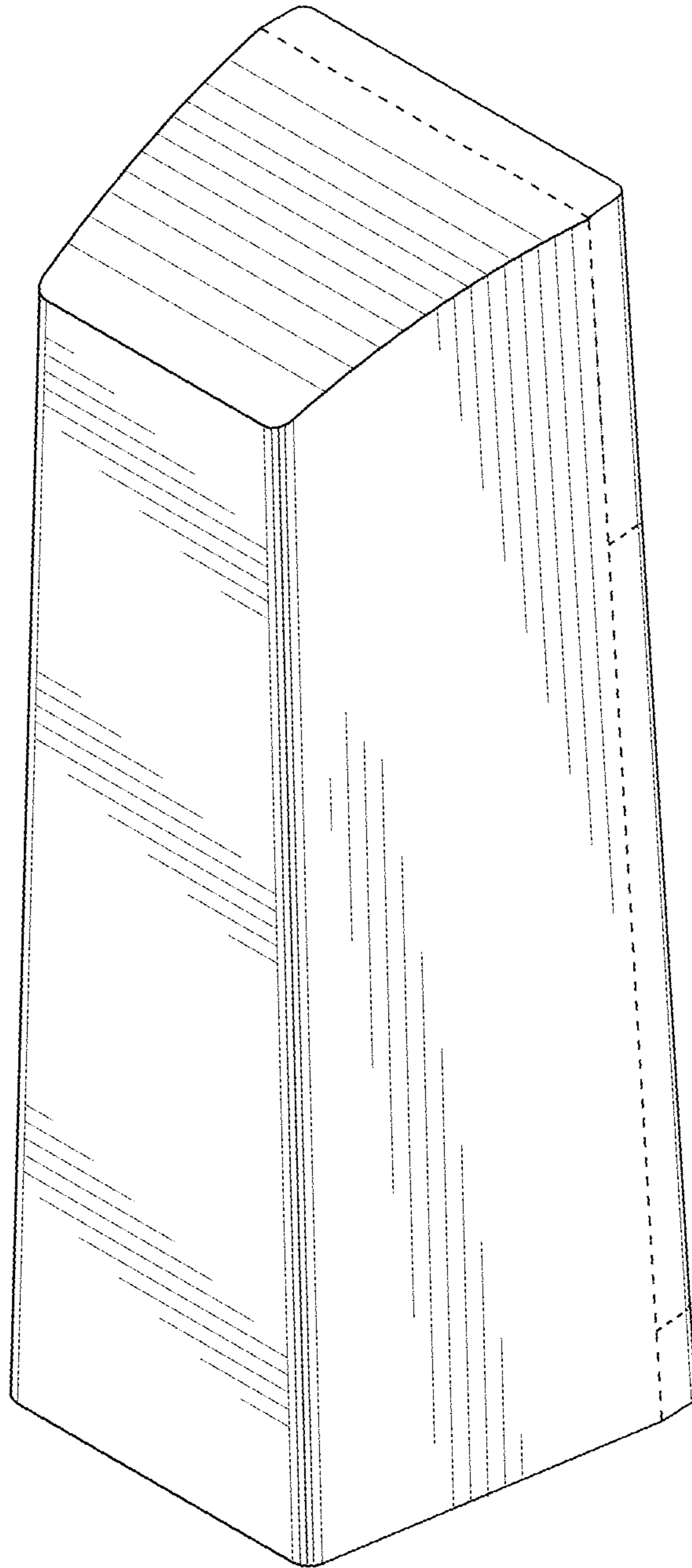

FIG.2

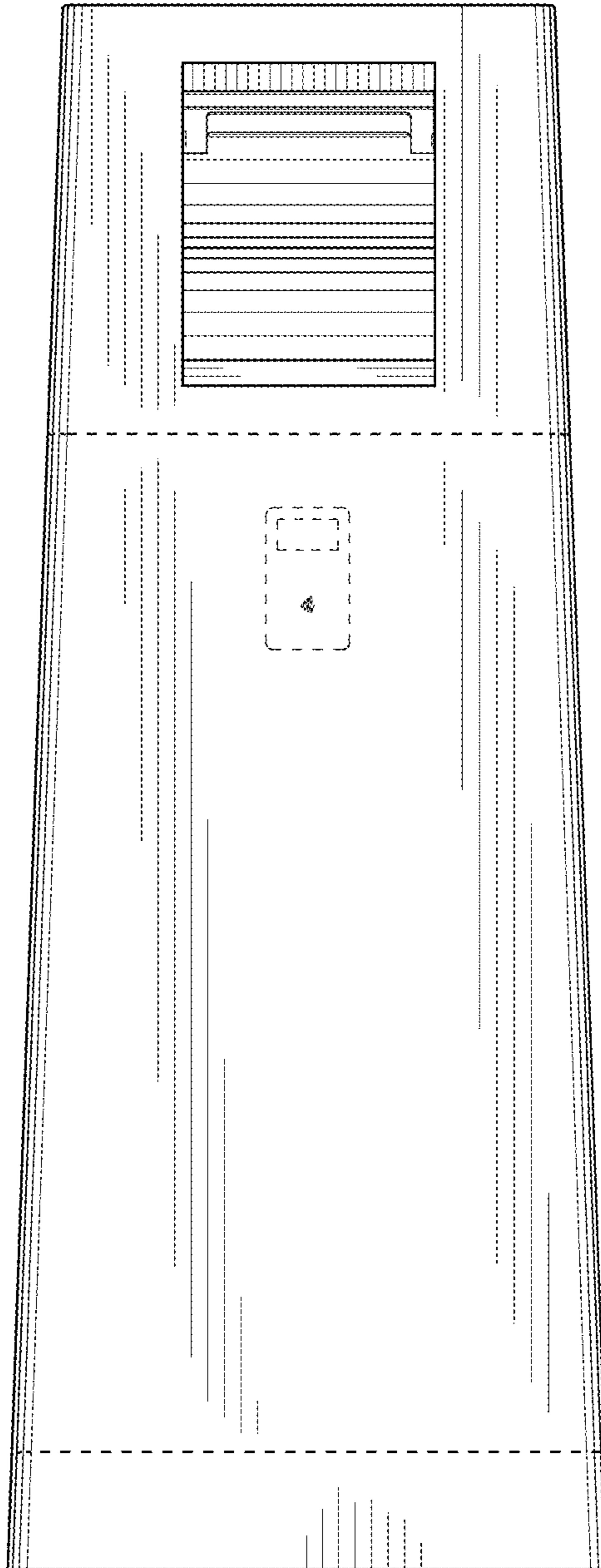

FIG.3

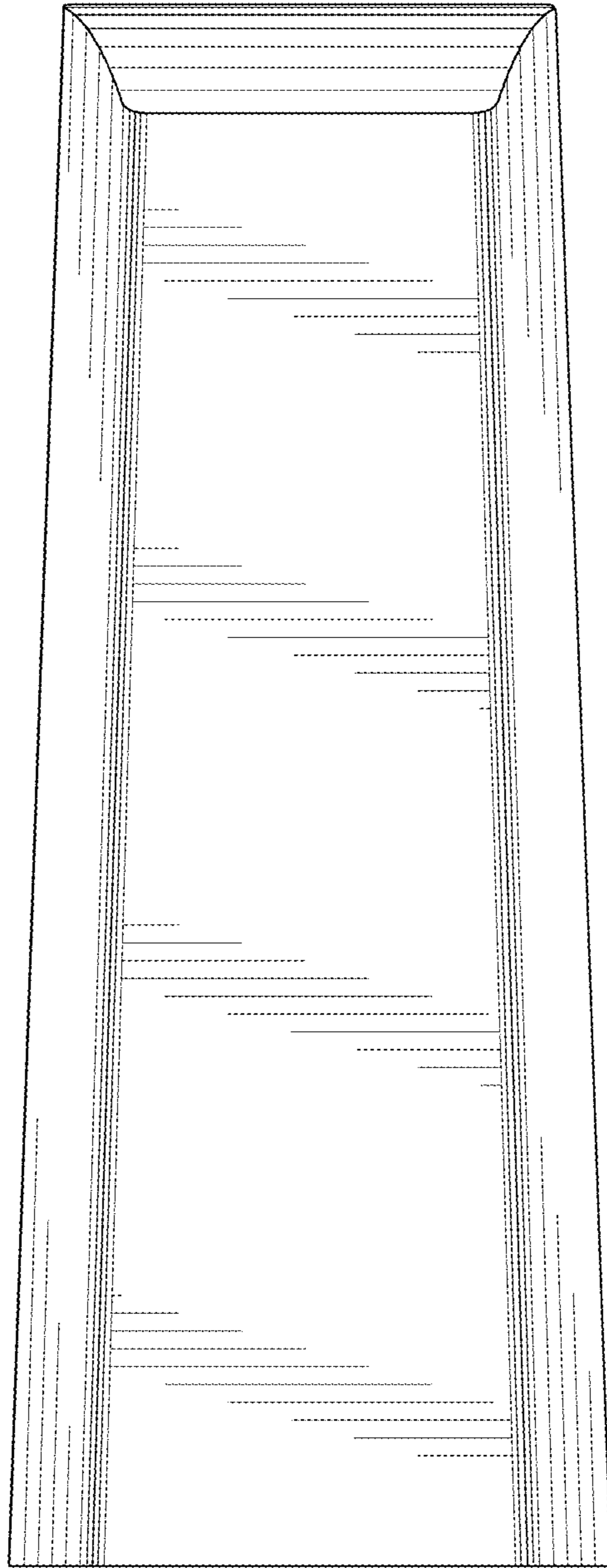

FIG.4

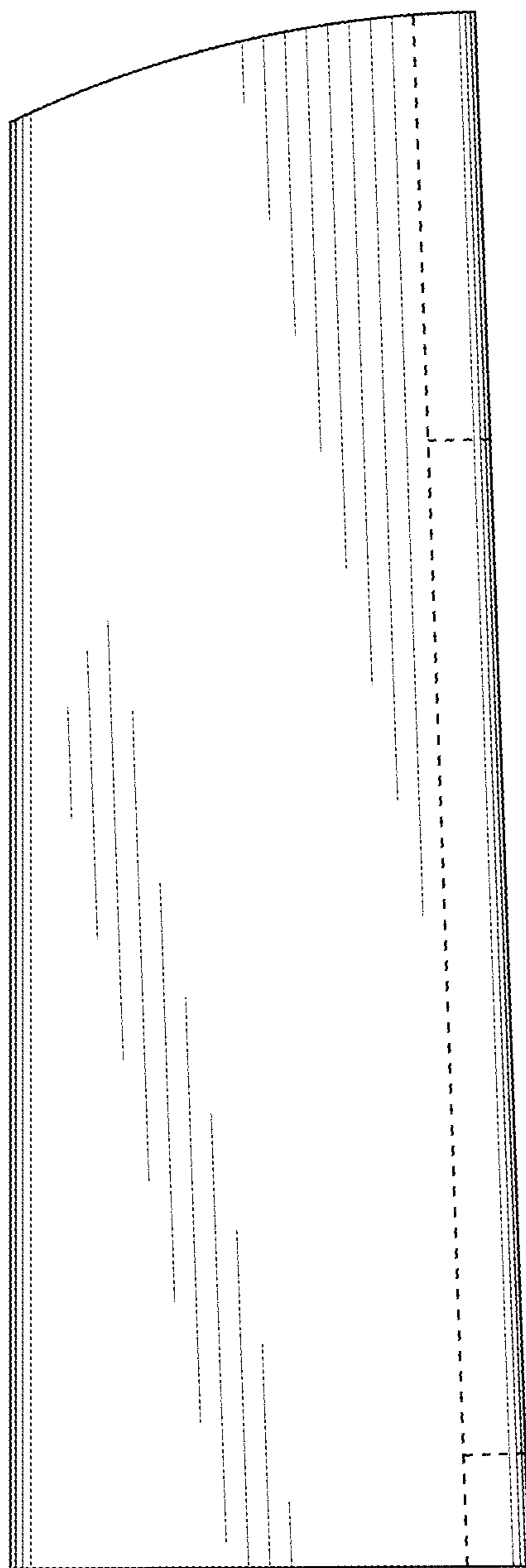

FIG.5

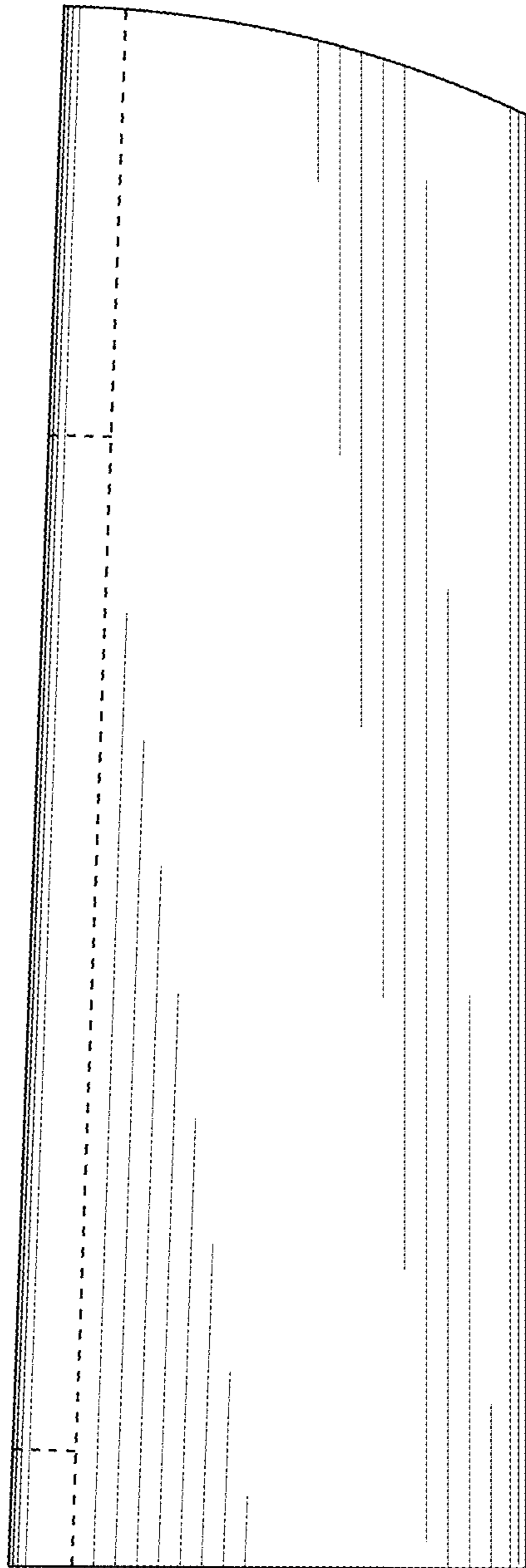

FIG.6

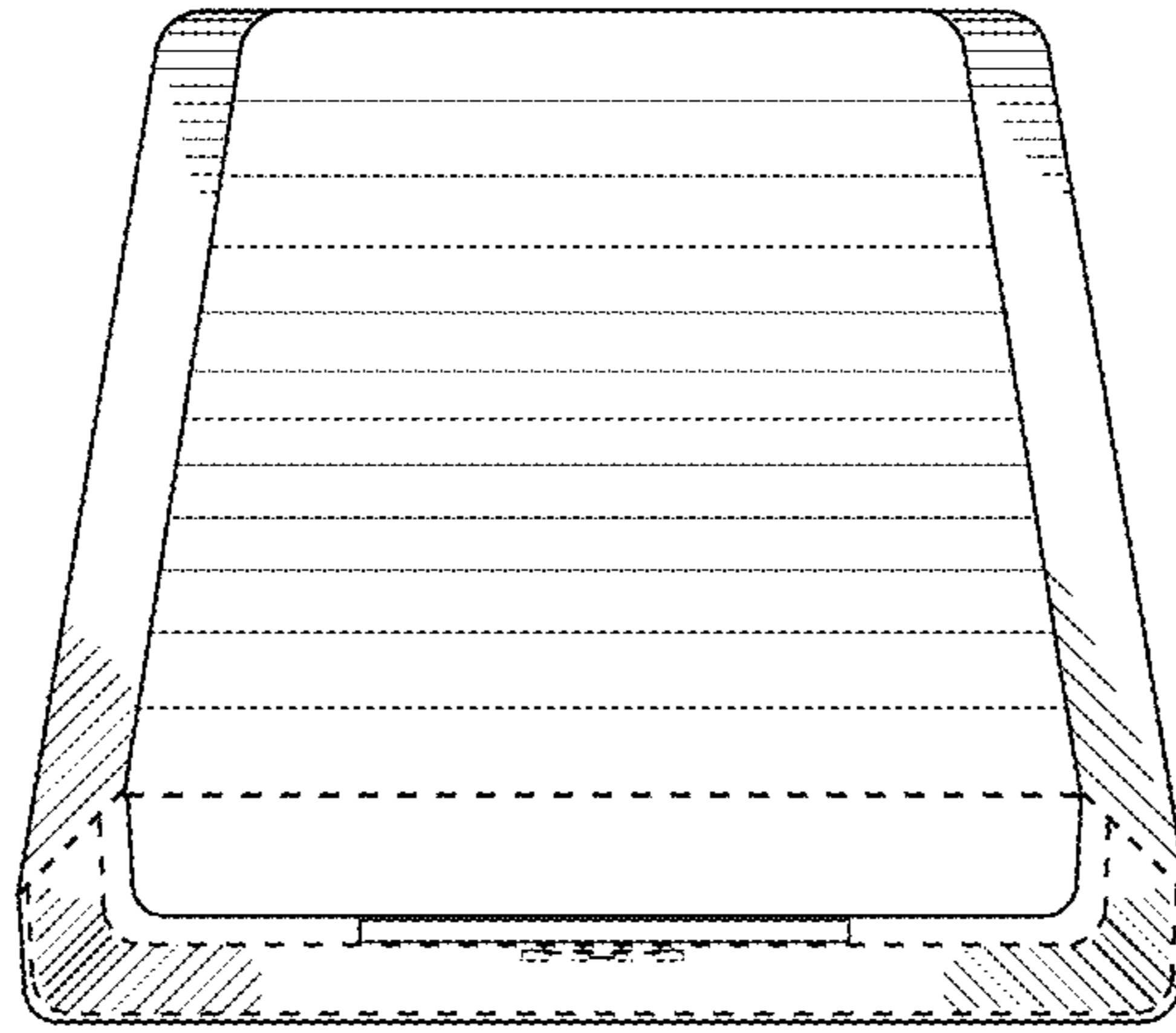

FIG. 7

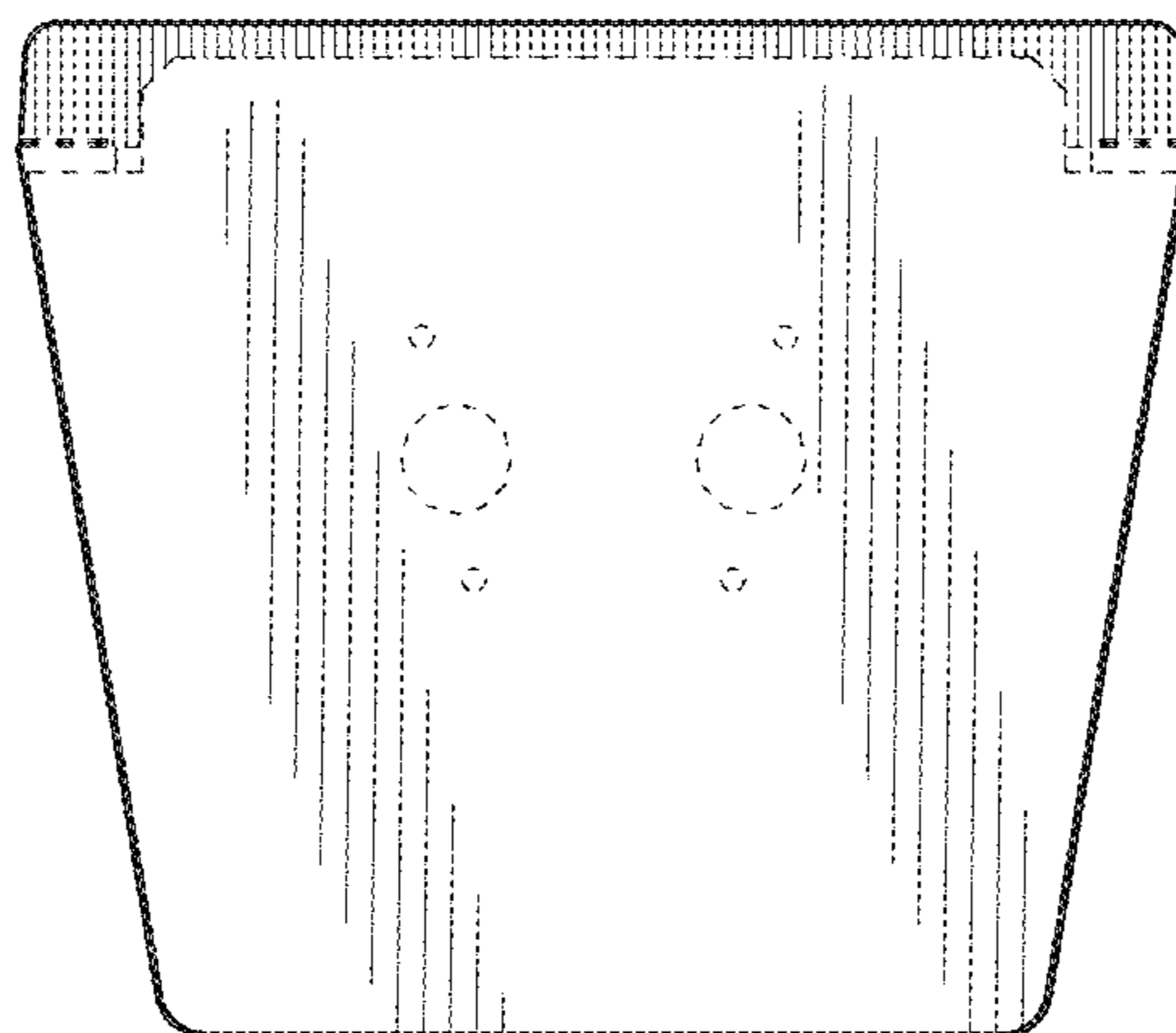

FIG. 8

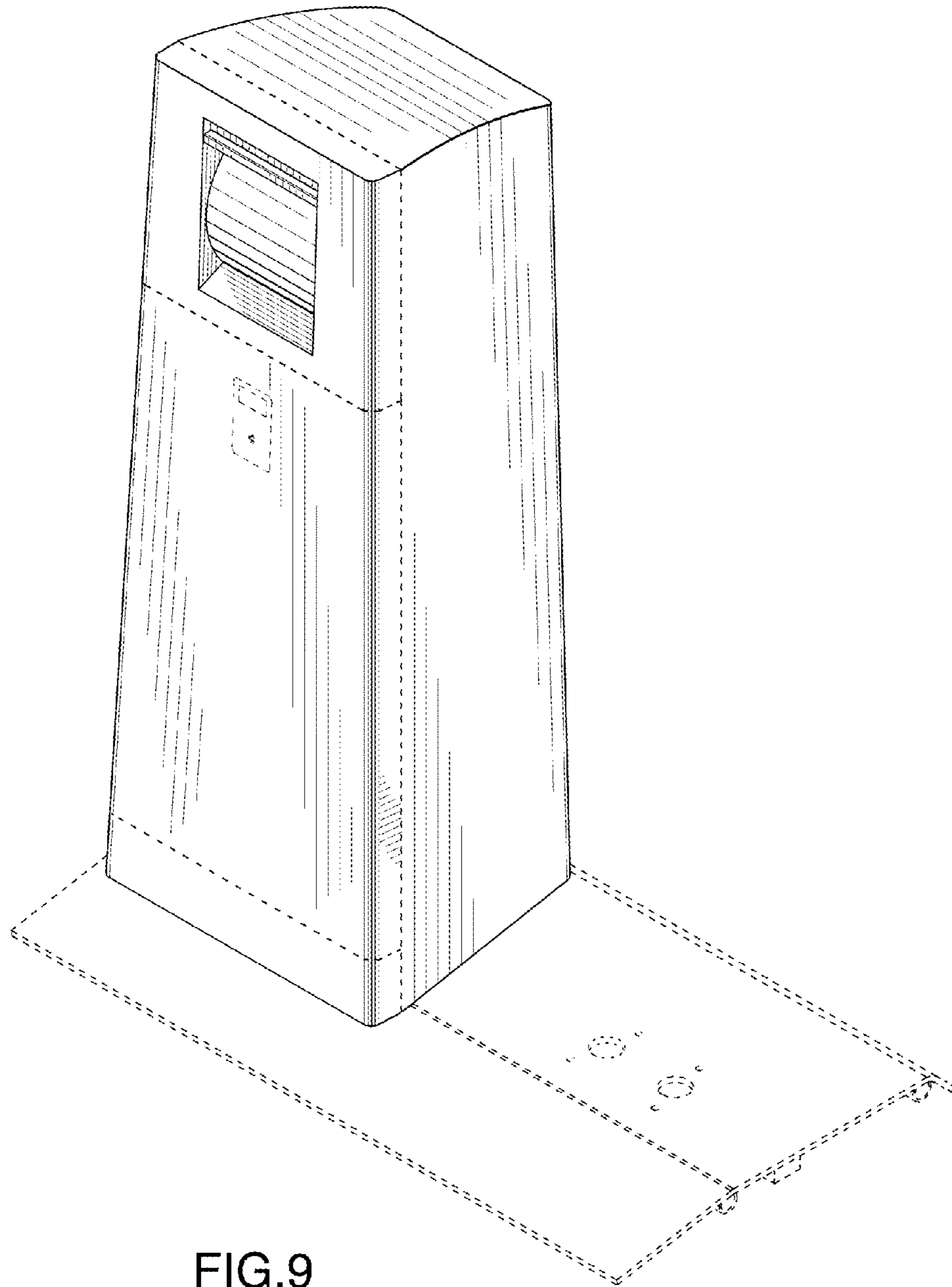

FIG.9