



US00D711599S

(12) **United States Design Patent**  
**Mahsetky**

(10) **Patent No.:** **US D711,599 S**

(45) **Date of Patent:** **\*\* Aug. 19, 2014**

(54) **DOG HEAD COVERING**

(76) Inventor: **Angela B. Mahsetky**, Saint Cloud, FL  
(US)

(\*\*) Term: **14 Years**

(21) Appl. No.: **29/425,705**

(22) Filed: **Jun. 26, 2012**

(51) **LOC (10) Cl.** ..... **30-01**

(52) **U.S. Cl.**  
USPC ..... **D30/144; D30/145; D2/500; D2/600**

(58) **Field of Classification Search**

CPC ... A01K 13/006; A01K 13/001; A41D 27/18;  
A41D 13/0512; A62B 27/04; A62B 27/08;  
A42B 1/046; A42B 1/04

USPC ..... D30/144, 145, 152, 199; D2/500, 501,  
D2/502, 600, 602, 878, 881; 119/850, 855,  
119/856; 54/79.1-79.4; 2/91, 171, 202,  
2/203, 206, 207, 208, 468, 84; D29/108

See application file for complete search history.

(56) **References Cited**

**U.S. PATENT DOCUMENTS**

2,080,382	A *	5/1937	Siegel	.....	2/171
3,753,334	A	8/1973	Blessing		
3,918,238	A *	11/1975	Iozzio	.....	54/79.2
3,968,521	A *	7/1976	Bashlow	.....	2/203
D295,565	S	5/1988	Upton et al.		
5,007,115	A *	4/1991	Denbow et al.	.....	2/208
5,031,388	A	7/1991	Ode		
5,163,272	A	11/1992	Finley et al.		
D339,676	S *	9/1993	Geving	.....	D2/500
D369,442	S *	4/1996	Jones	.....	D29/108

D374,315	S *	10/1996	Caditz	.....	D30/145
D406,936	S *	3/1999	Sivret et al.	.....	D2/881
D417,315	S	11/1999	Lowry		
D488,613	S *	4/2004	Easlick	.....	D2/600
D558,956	S *	1/2008	Pritchett	.....	D2/878
D569,079	S *	5/2008	Whong	.....	D2/502
D602,212	S *	10/2009	Prill	.....	D30/145
7,818,819	B2 *	10/2010	Chiang	.....	2/206
7,946,256	B2	5/2011	Mann		
D665,536	S *	8/2012	Jenke et al.	.....	D29/108
2009/0178628	A1	7/2009	Carmean et al.		
2009/0276938	A1 *	11/2009	Chiang	.....	2/206
2010/0037367	A1 *	2/2010	Benderradji	.....	2/202
2012/0023639	A1 *	2/2012	Rojas Mas	.....	2/84
2012/0030859	A1 *	2/2012	Kroese et al.	.....	2/207
2012/0210501	A1 *	8/2012	Lavin	.....	2/468

\* cited by examiner

*Primary Examiner* — Martie K Holtje

(57) **CLAIM**

The ornamental design for a dog head covering, as shown and described.

**DESCRIPTION**

FIG. 1 is a side elevational view of a dog head covering showing my new design;

FIG. 2 is a rear elevational view thereof;

FIG. 3 is a front elevational view thereof;

FIG. 4 is a top plan view thereof;

FIG. 5 is a bottom plan view thereof; and,

FIG. 6 is a front perspective view thereof shown in use.

The dog depicted by broken lines in FIG. 6 has been shown for the purpose of illustrating environment that forms no part of the claimed design.

**1 Claim, 3 Drawing Sheets**

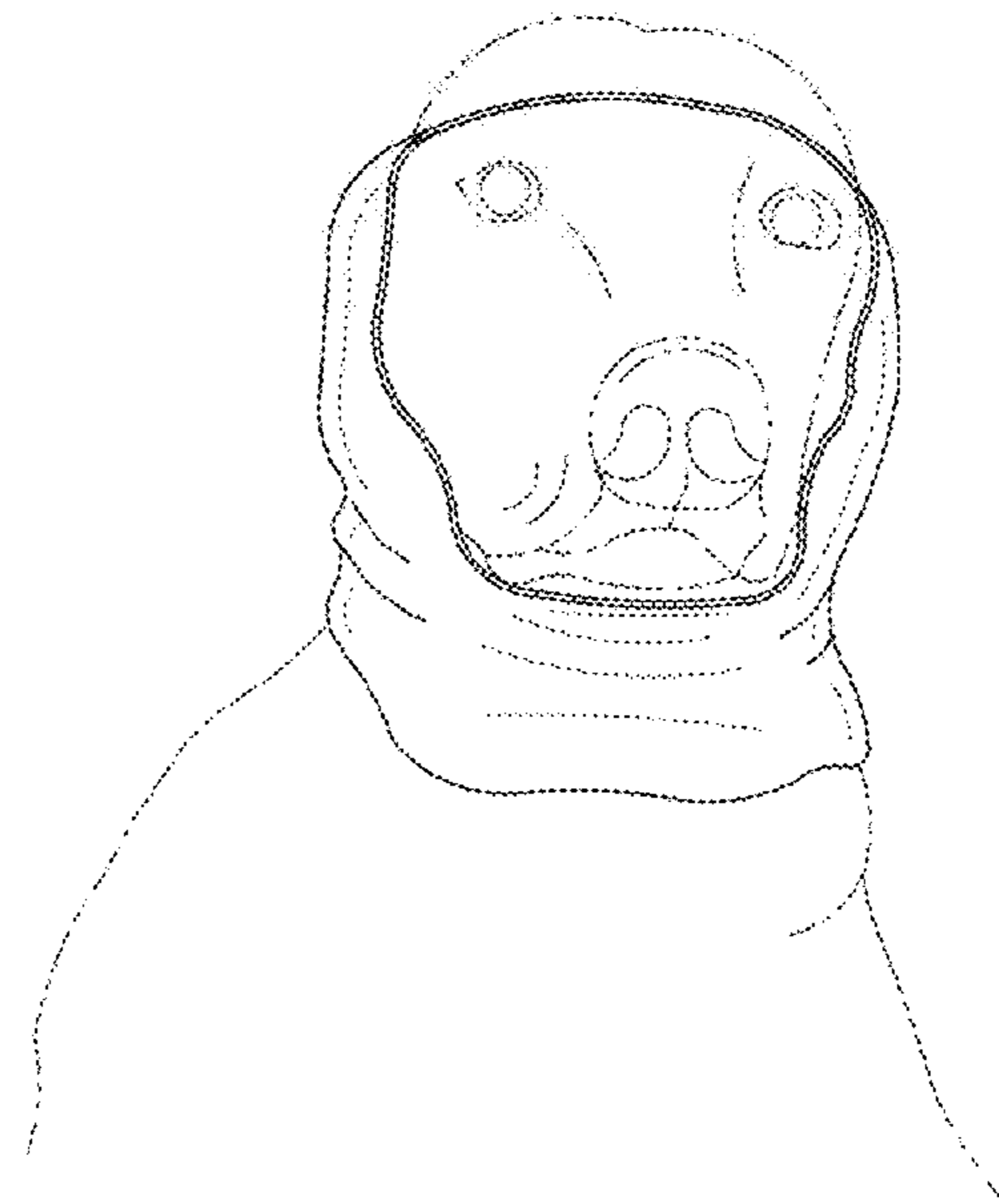
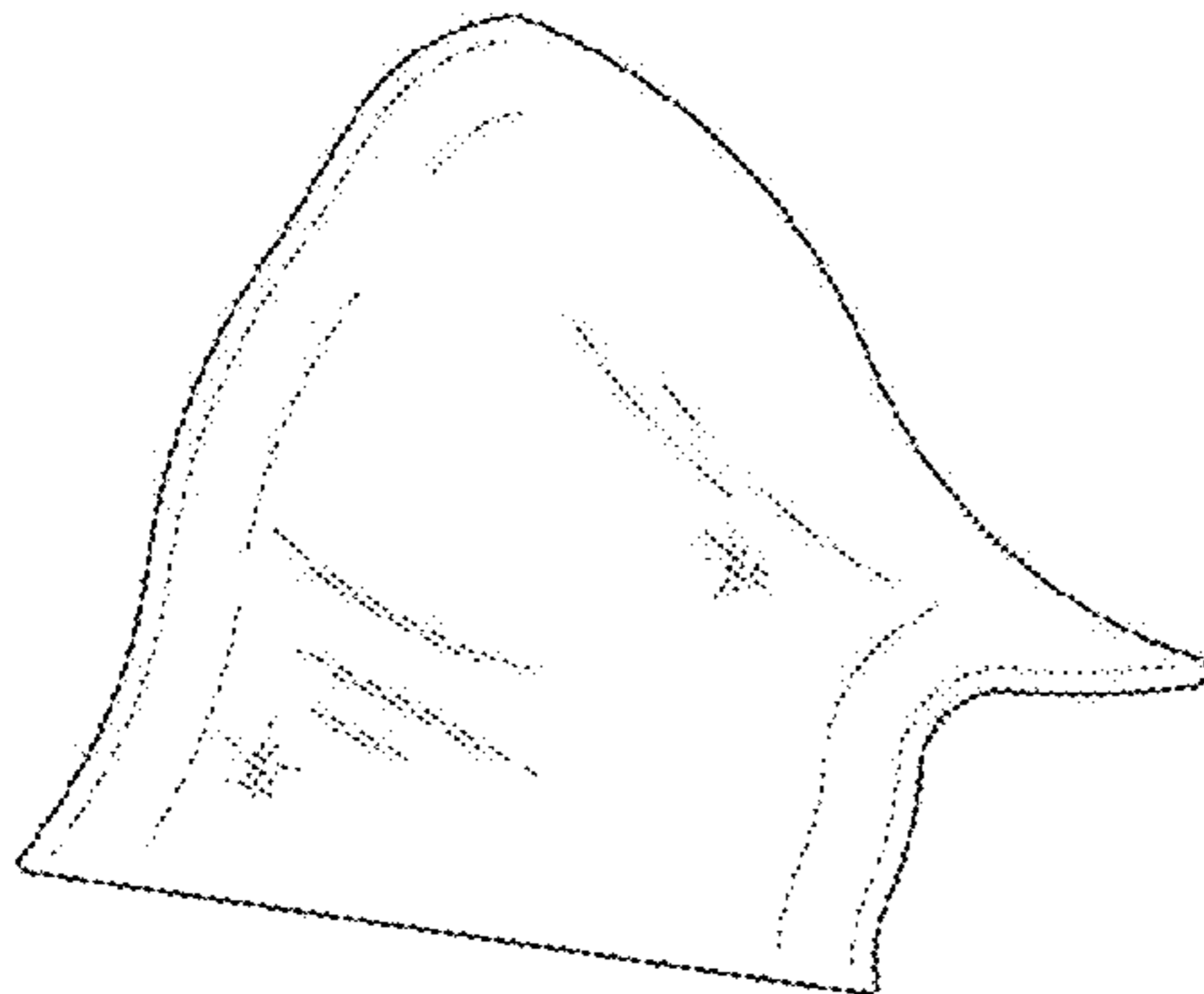

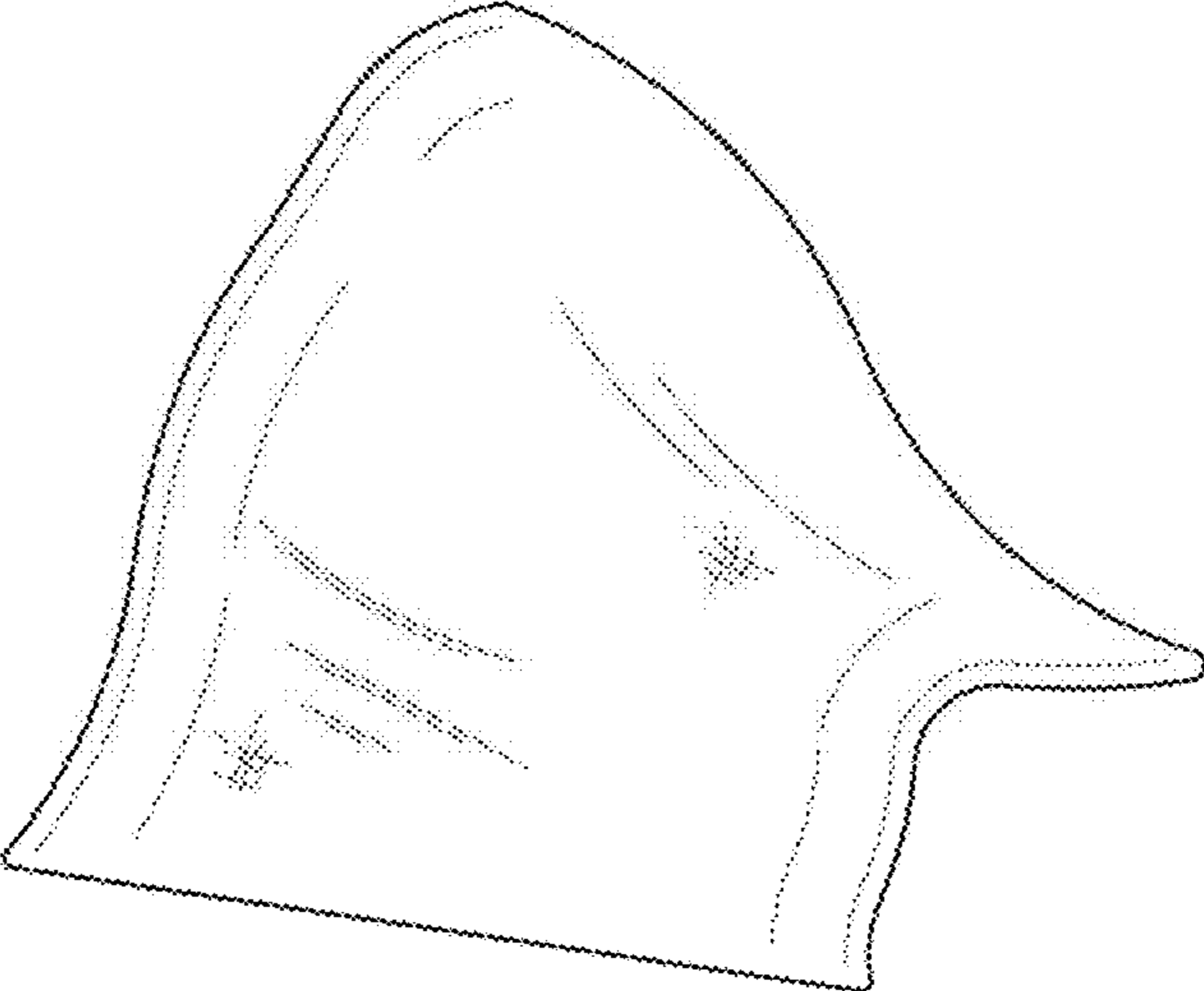

FIG. 1

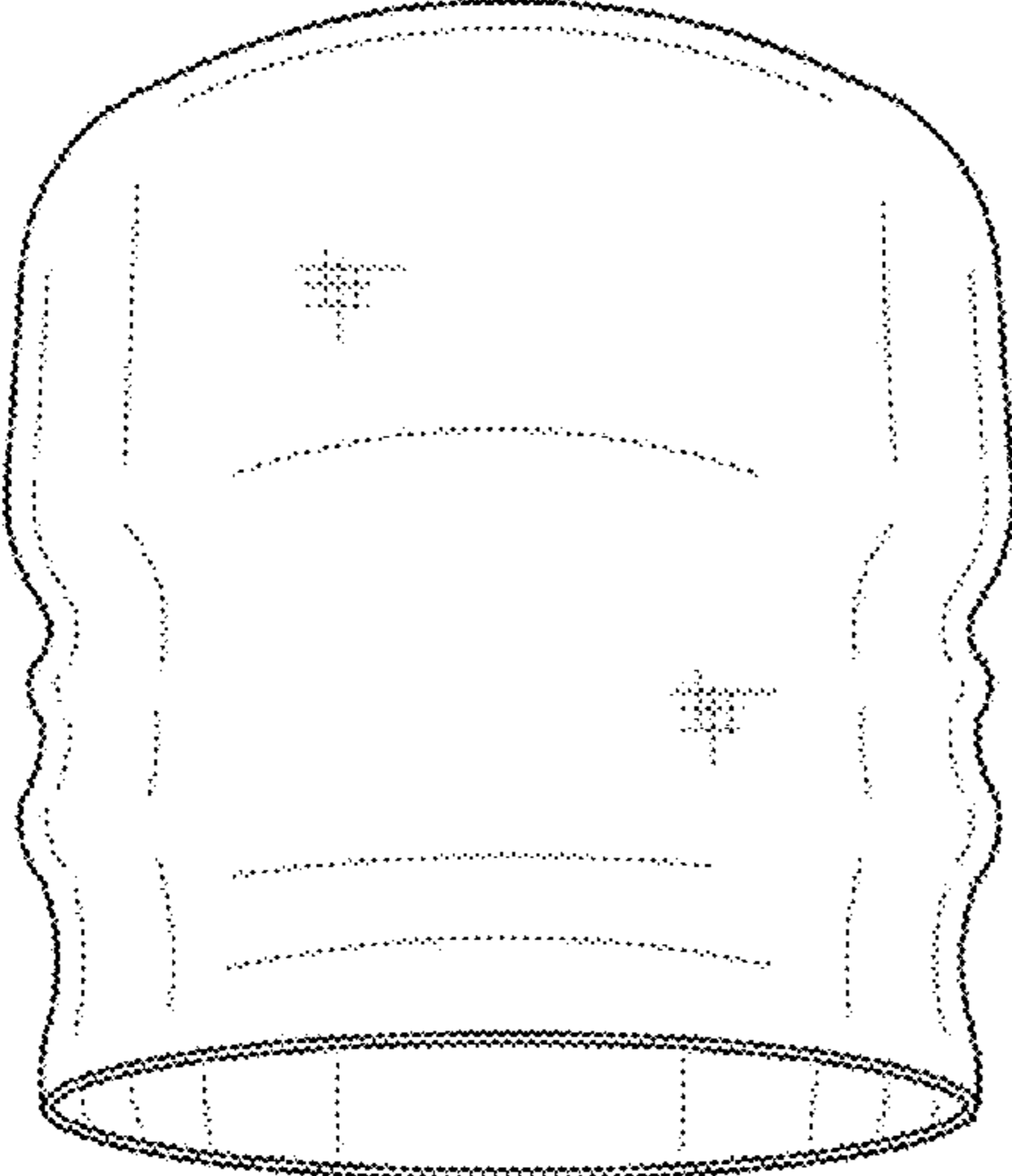

FIG. 2

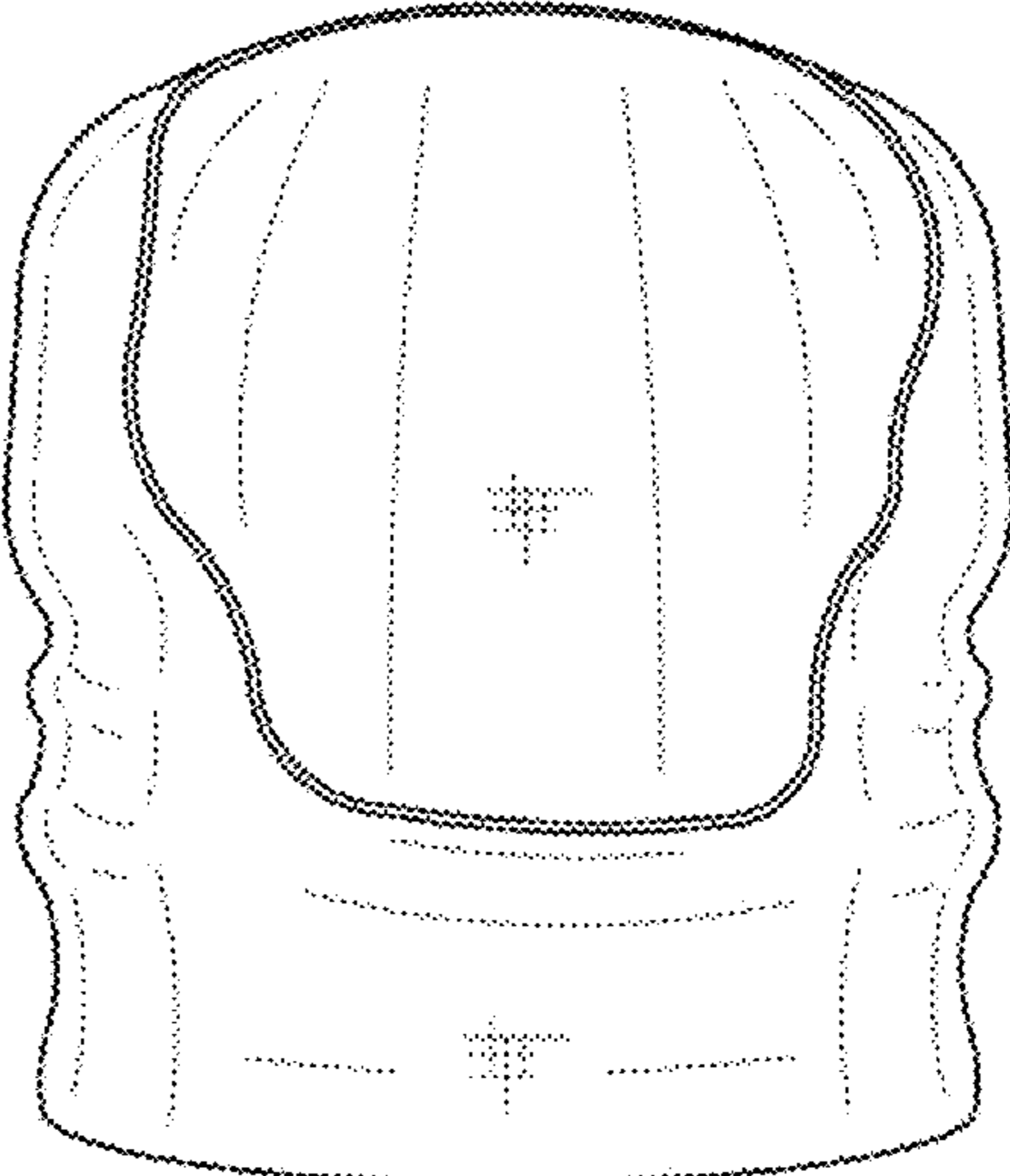

FIG. 3

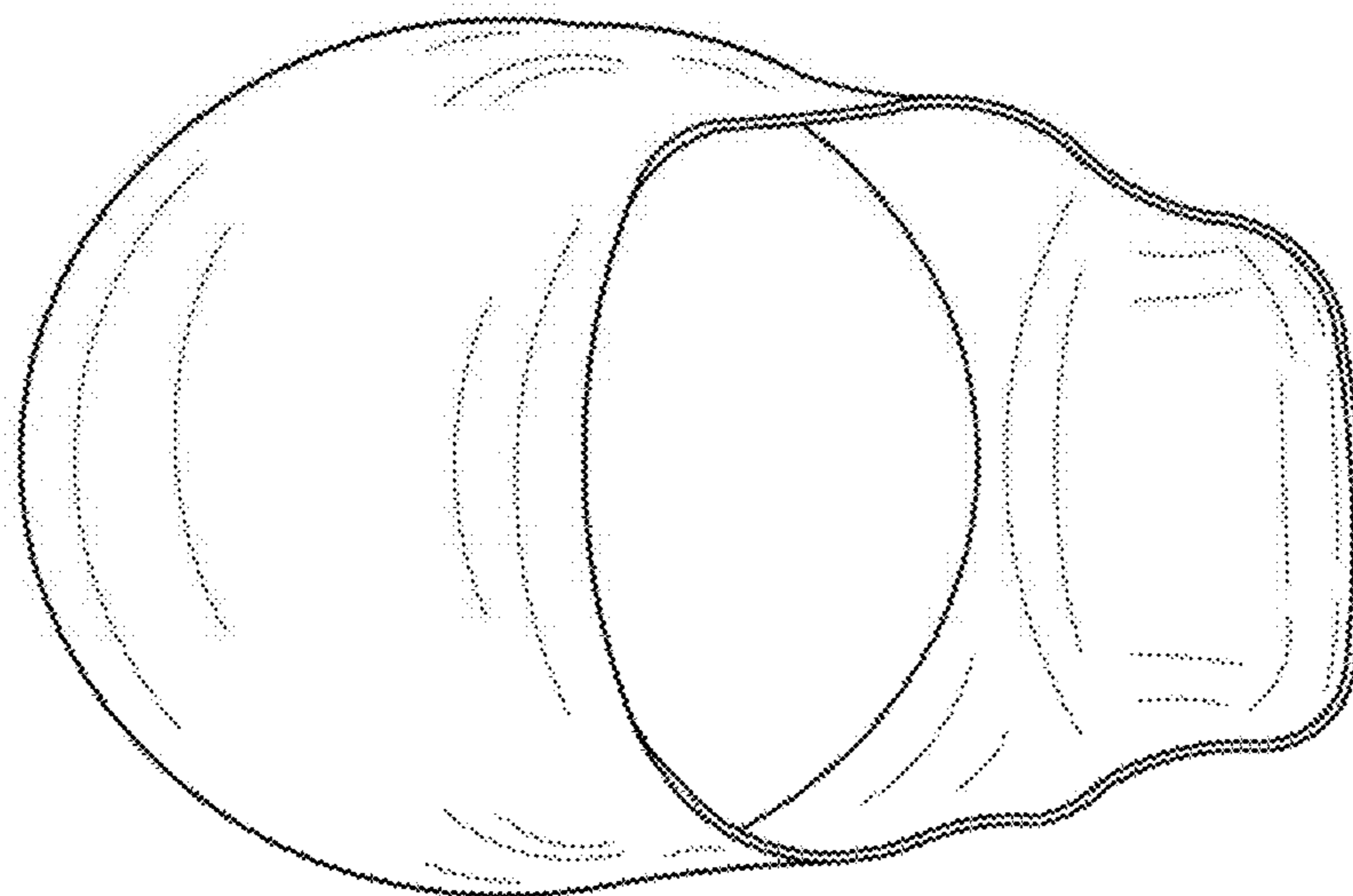

FIG. 4

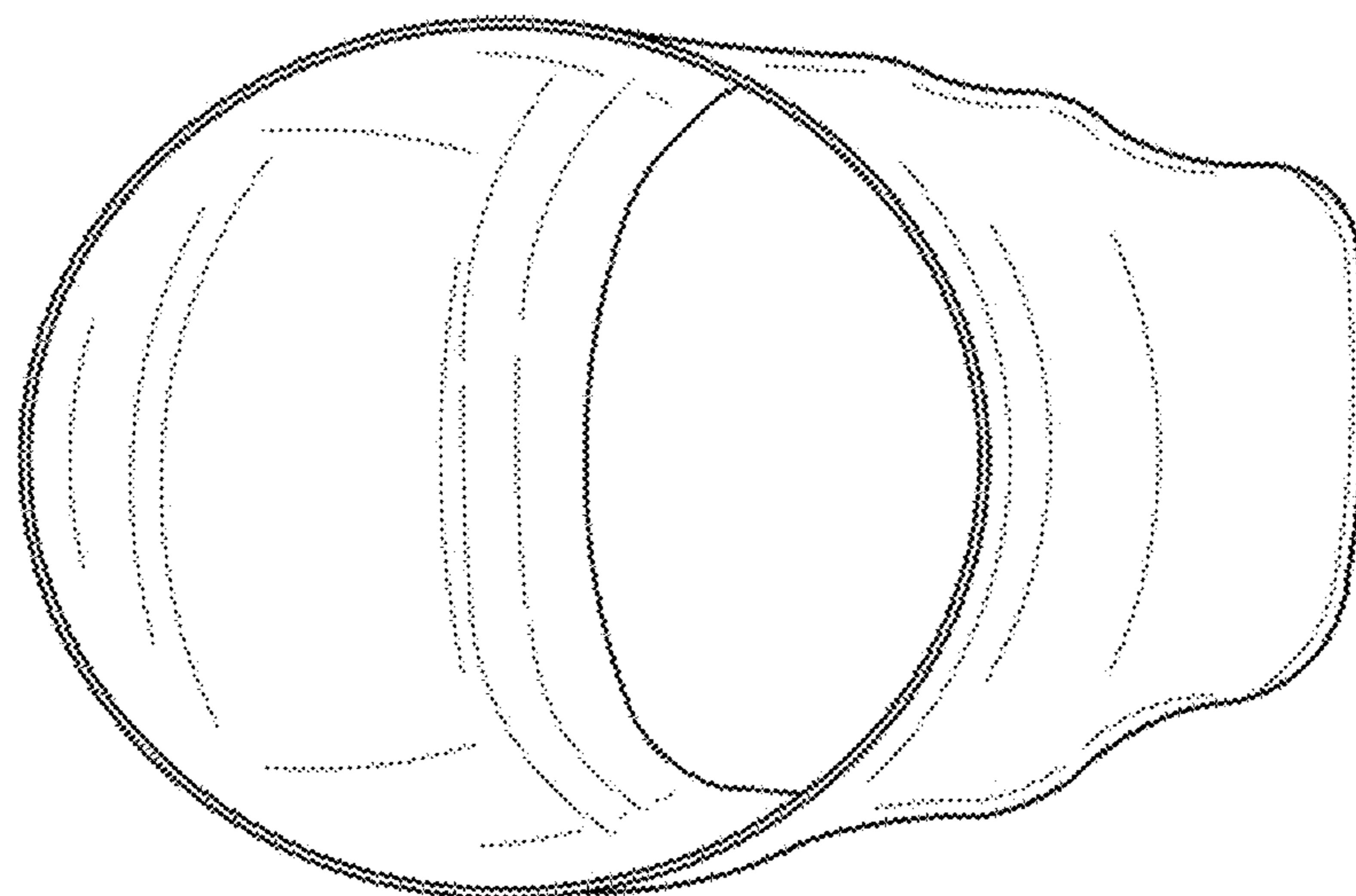

FIG. 5



FIG. 6