



US00D711558S

(12) **United States Design Patent**
Bobolts et al.

(10) **Patent No.:** **US D711,558 S**

(45) **Date of Patent:** **** Aug. 19, 2014**

(54) **ROOF TILE**

(71) Applicant: **Boral Roofing LLC**, Roswell, GA (US)

(72) Inventors: **Jeffrey Thomas Bobolts**, Murrieta, CA (US); **John Stuart Renowden**, Newport Beach, CA (US); **Michael Winfried Vogel**, Alta Loma, CA (US); **Cyrus Falatoon**, Alta Loma, CA (US)

(73) Assignee: **Boral Roofing LLC**, Roswell, GA (US)

(**) Term: **14 Years**

(21) Appl. No.: **29/439,774**

(22) Filed: **Dec. 14, 2012**

(51) **LOC (10) Cl.** **25-01**

(52) **U.S. Cl.**
USPC **D25/140**

(58) **Field of Classification Search**
CPC E04D 1/30; E04D 1/12; E04D 1/14;
E04D 1/24
USPC 52/518, 519, 553, 527; D25/139, 140
See application file for complete search history.

(56) **References Cited**

U.S. PATENT DOCUMENTS

3,862,532 A * 1/1975 Markos 52/521
D321,942 S * 11/1991 Lynn D25/140
D518,902 S 4/2006 Beetler et al.

D538,448 S * 3/2007 Fifield et al. D25/140
D568,497 S 5/2008 Burman et al.
8,122,649 B2 2/2012 Thomas
2005/0257477 A1 11/2005 Beetler et al.
2008/0098684 A1* 5/2008 Martinique 52/527

* cited by examiner

Primary Examiner — Doris Clark

(74) *Attorney, Agent, or Firm* — Joel T. Charlton

(57) **CLAIM**

We claim the ornamental design for a roof tile, as shown and described.

DESCRIPTION

FIG. 1 is a front perspective view of a roof tile according to the present design;

FIG. 2 is a front elevation view of the roof tile shown in FIG. 1;

FIG. 3 is a rear elevation view of the roof tile shown in FIG. 1;

FIG. 4 is a bottom plan view of the roof tile shown in FIG. 1;

FIG. 5 is a top plan view of the roof tile shown in FIG. 1;

FIG. 6 is a left side elevation view of the roof tile shown in FIG. 1; and,

FIG. 7 is a right side elevation view of the roof tile shown in FIG. 1.

The broken lines are for illustrative purposes only and form no part of the claimed design.

1 Claim, 5 Drawing Sheets

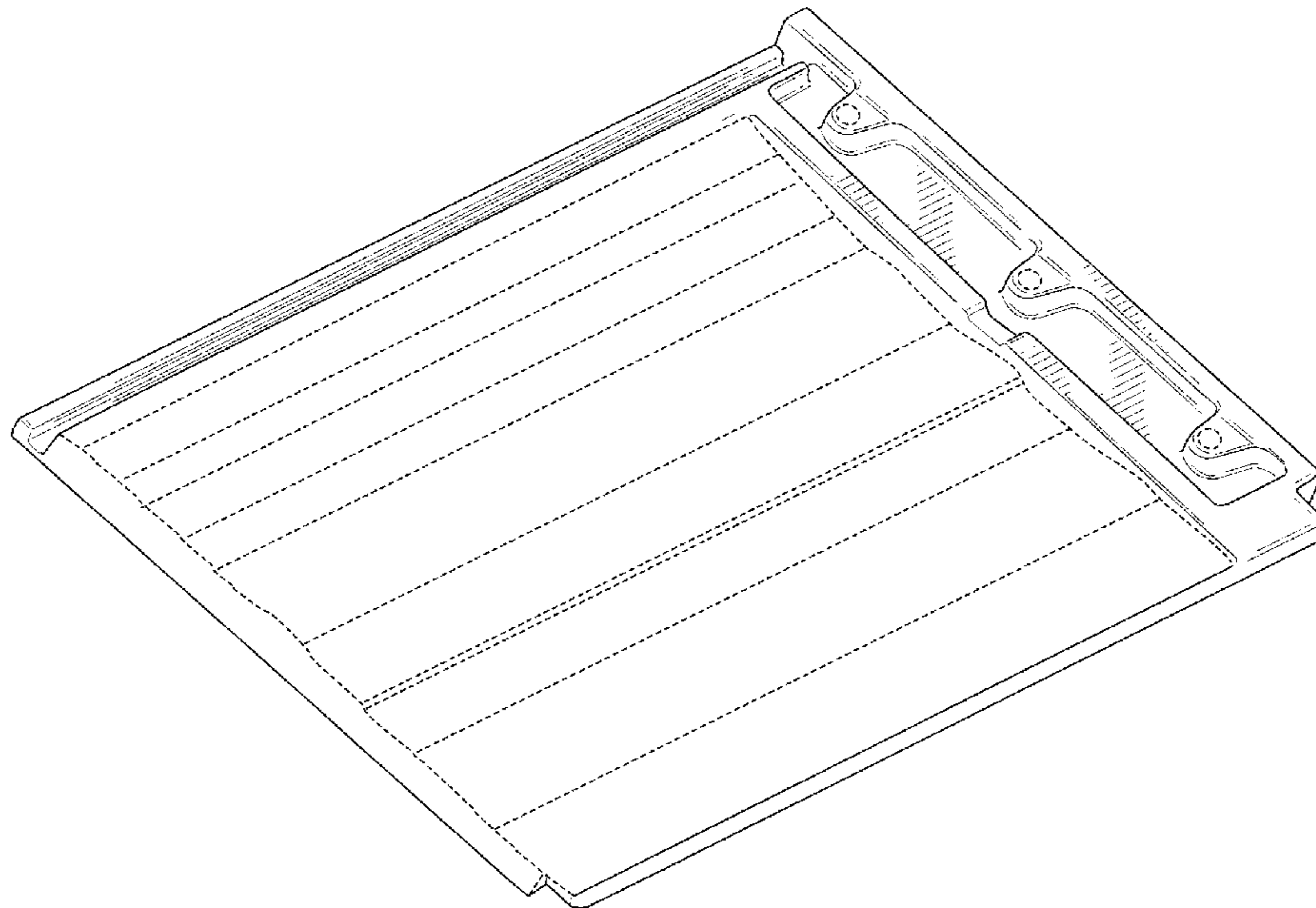

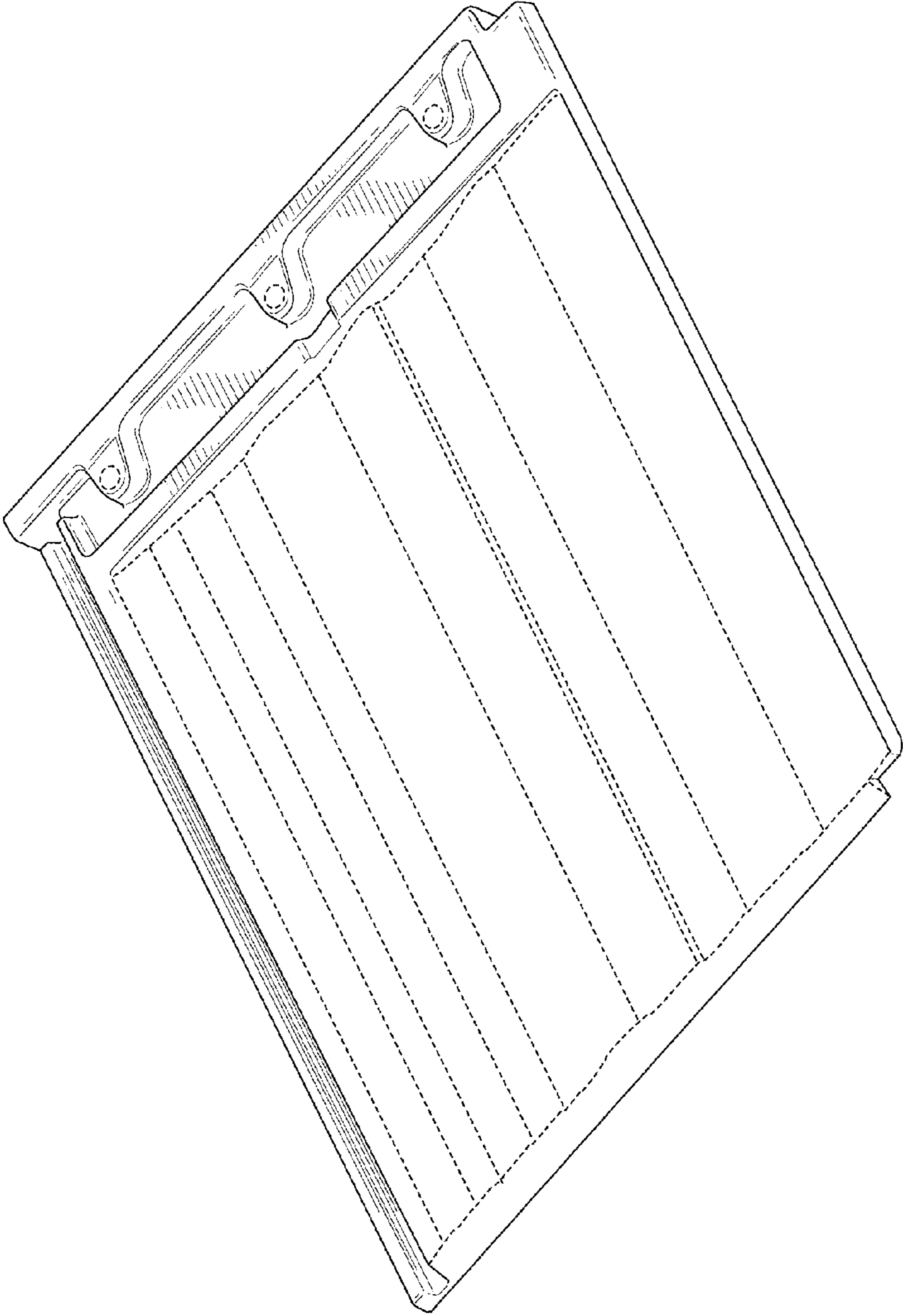

FIG. 1

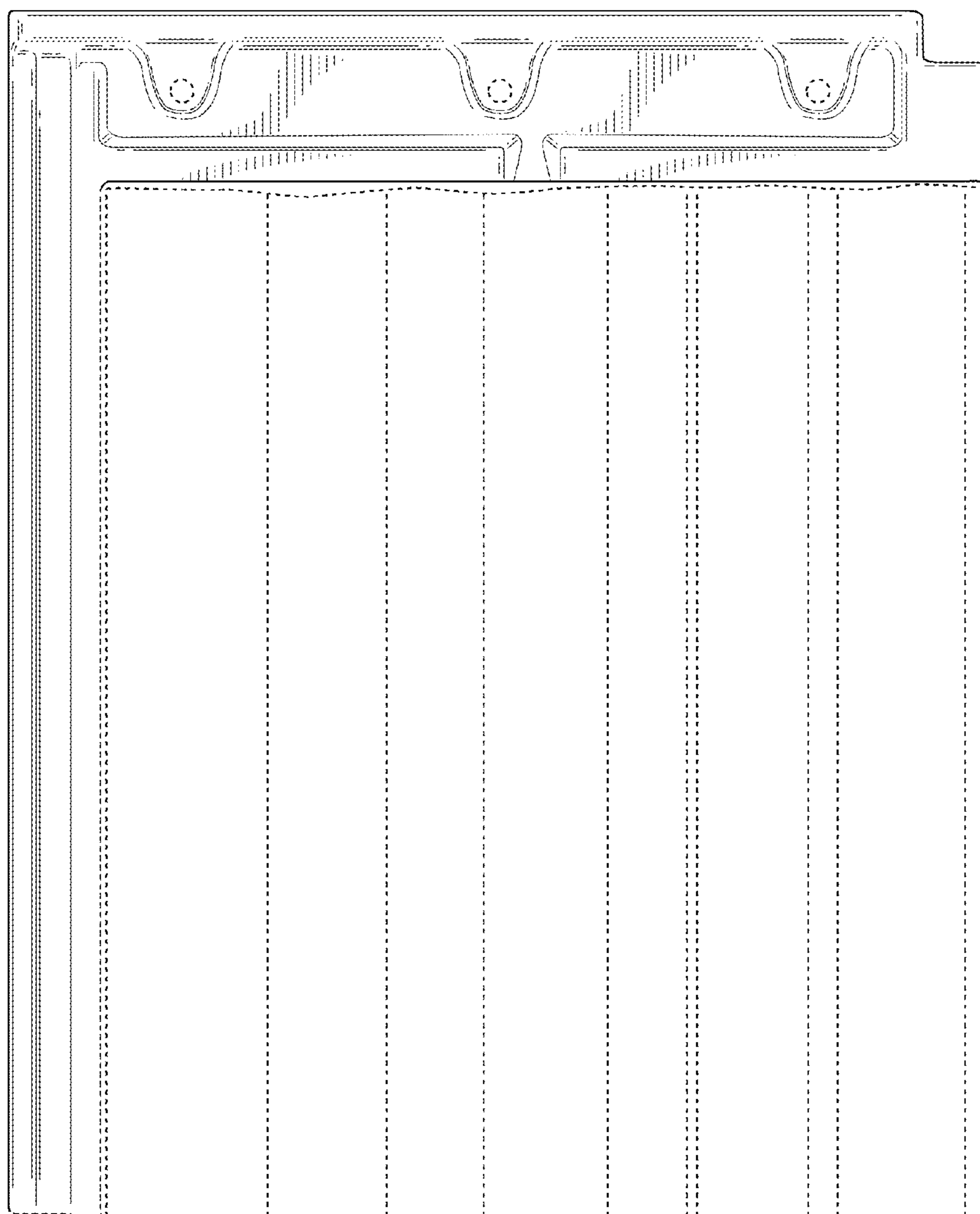

FIG. 2

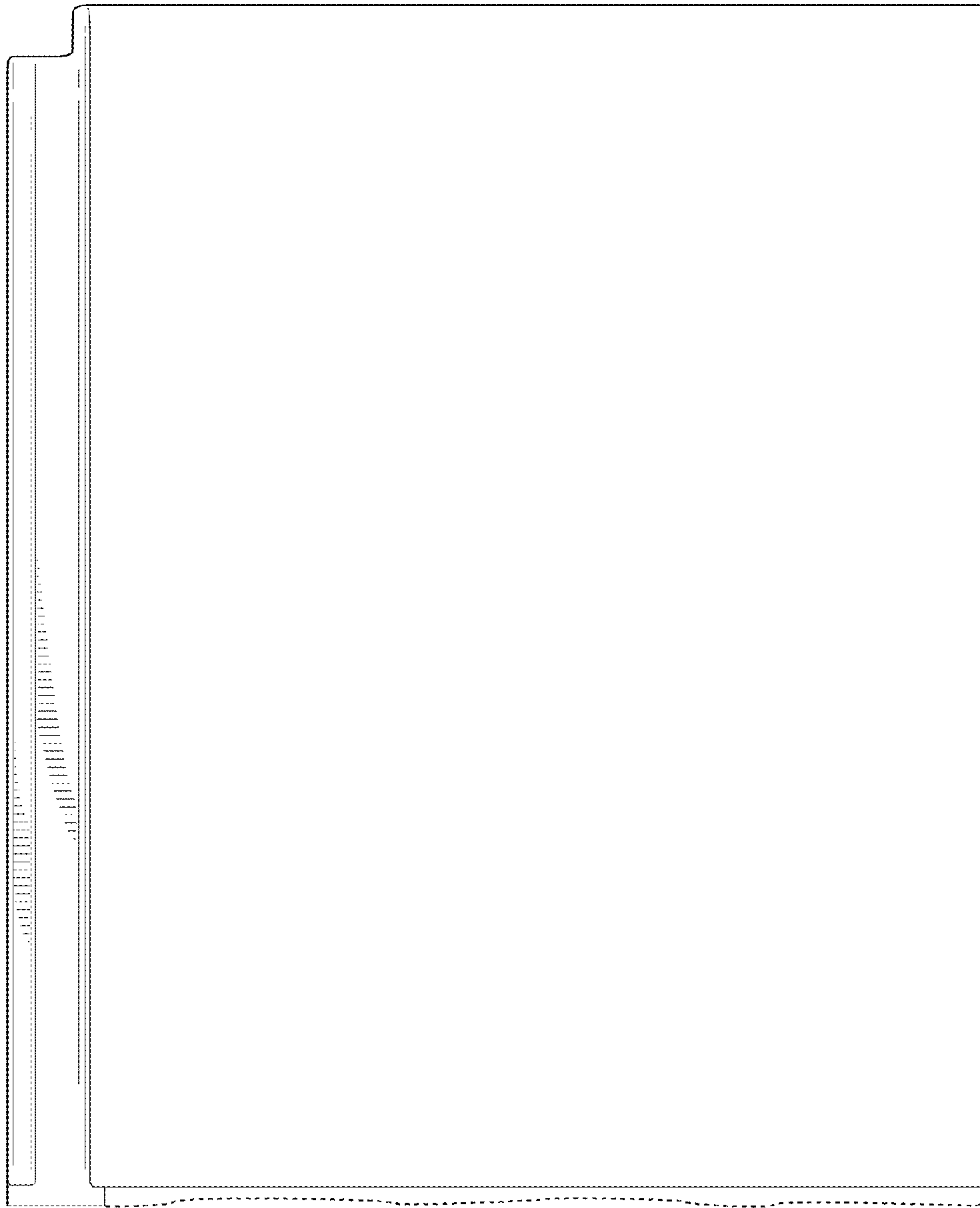

FIG. 3

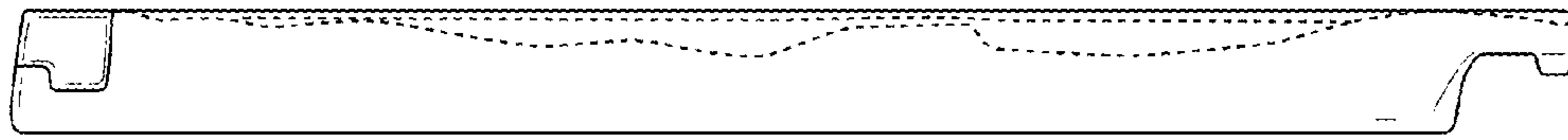

FIG. 4

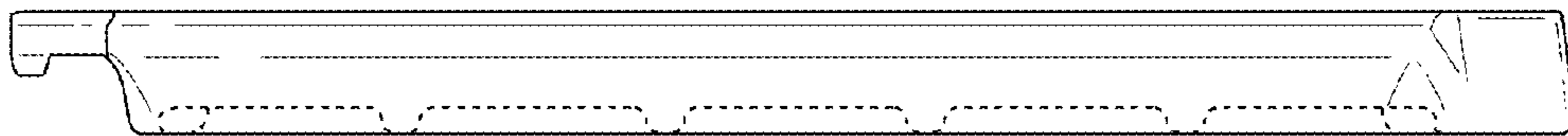

FIG. 5

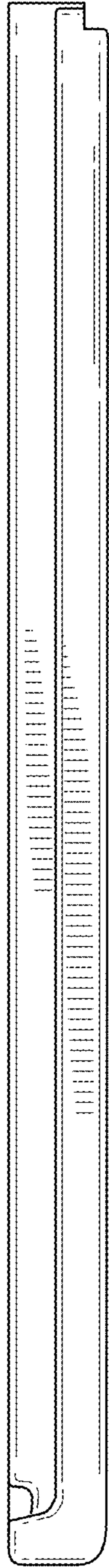

FIG. 6

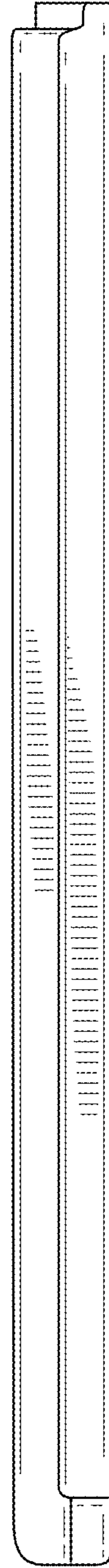

FIG. 7