



US00D711544S

(12) **United States Design Patent**  
**Soltész-Nagy**

(10) **Patent No.:** **US D711,544 S**

(45) **Date of Patent:** **\*\* Aug. 19, 2014**

(54) **SOLARIUM**

(71) Applicant: **Attila Soltész-Nagy**, Budapest (HU)

(72) Inventor: **Attila Soltész-Nagy**, Budapest (HU)

(\*\*) Term: **14 Years**

(21) Appl. No.: **29/445,531**

(22) Filed: **Feb. 13, 2013**

(30) **Foreign Application Priority Data**

Aug. 13, 2012 (HU) ..... D1200119

(51) **LOC (10) CL.** ..... **28-03**

(52) **U.S. Cl.**

USPC ..... **D24/210**

(58) **Field of Classification Search**

CPC ..... A61N 5/0614; A61N 2005/0636;  
A61N 2005/0655; A61N 5/0616; A61N  
2005/0633; A61N 2005/0652; A61N  
2005/0659; A61M 35/00

USPC ..... D24/133, 158, 163, 188, 200, 209–210;  
607/88–95

See application file for complete search history.

(56) **References Cited**

**U.S. PATENT DOCUMENTS**

709,696	A *	9/1902	Brueck	607/91
4,103,175	A *	7/1978	Levin	250/504 R
4,469,102	A *	9/1984	Fish	607/91
4,590,940	A *	5/1986	Pigmans	607/91
D285,607	S *	9/1986	Macier	D24/210
D289,686	S *	5/1987	Springer, Jr.	D24/210
4,740,707	A *	4/1988	Thaw	607/94
5,957,959	A *	9/1999	Rissmaney et al.	607/88
6,402,774	B1 *	6/2002	Caldironi	607/91
7,481,833	B2 *	1/2009	Dussault	607/91
D618,360	S *	6/2010	Mac	D24/209
D652,934	S *	1/2012	Dougherty, IV	D24/164
D657,058	S *	4/2012	Awad	D24/158
D676,564	S *	2/2013	Kawecki	D24/209

D693,479	S *	11/2013	McCall et al.	D24/231
2004/0073186	A1 *	4/2004	Cameron	604/389
2005/0159795	A1 *	7/2005	Savage et al.	607/88
2006/0020308	A1 *	1/2006	Muldner	607/88
2006/0118039	A1 *	6/2006	Cooper	118/696
2006/0265033	A1 *	11/2006	Bruto	607/94

(Continued)

*Primary Examiner* — Eric Goodman

*Assistant Examiner* — John Reickel

(74) *Attorney, Agent, or Firm* — Miltons IP/p.i.

(57) **CLAIM**

The ornamental design for a solarium, as shown and described.

**DESCRIPTION**

FIG. 1 is a bottom right perspective view of the design as applied to a solarium in an open position.

FIG. 2 is a top right perspective view of the design of FIG. 1 in an open position.

FIG. 3 is a bottom front perspective view of the design of FIG. 1 in an open position.

FIG. 4 is a top front perspective view of the design of FIG. 1 in an open position.

FIG. 5 is a bottom back perspective view of the design of FIG. 1 in an open position.

FIG. 6 is a top back perspective view of the design of FIG. 1 in an open position.

FIG. 7 is a top right back perspective view of the design of FIG. 1 in an open position.

FIG. 8 is a bottom right back perspective view of the design of FIG. 1 in an open position.

FIG. 9 is a front right view of the design of FIG. 1 in an open position.

FIG. 10 is a cross-section right view of the design of FIG. 12;

FIG. 11 is a cross-section left view of the design of FIG. 12;

and,  
FIG. 12 is a view of the design of FIG. 1 offset at an angle and in a closed position.

**1 Claim, 12 Drawing Sheets**

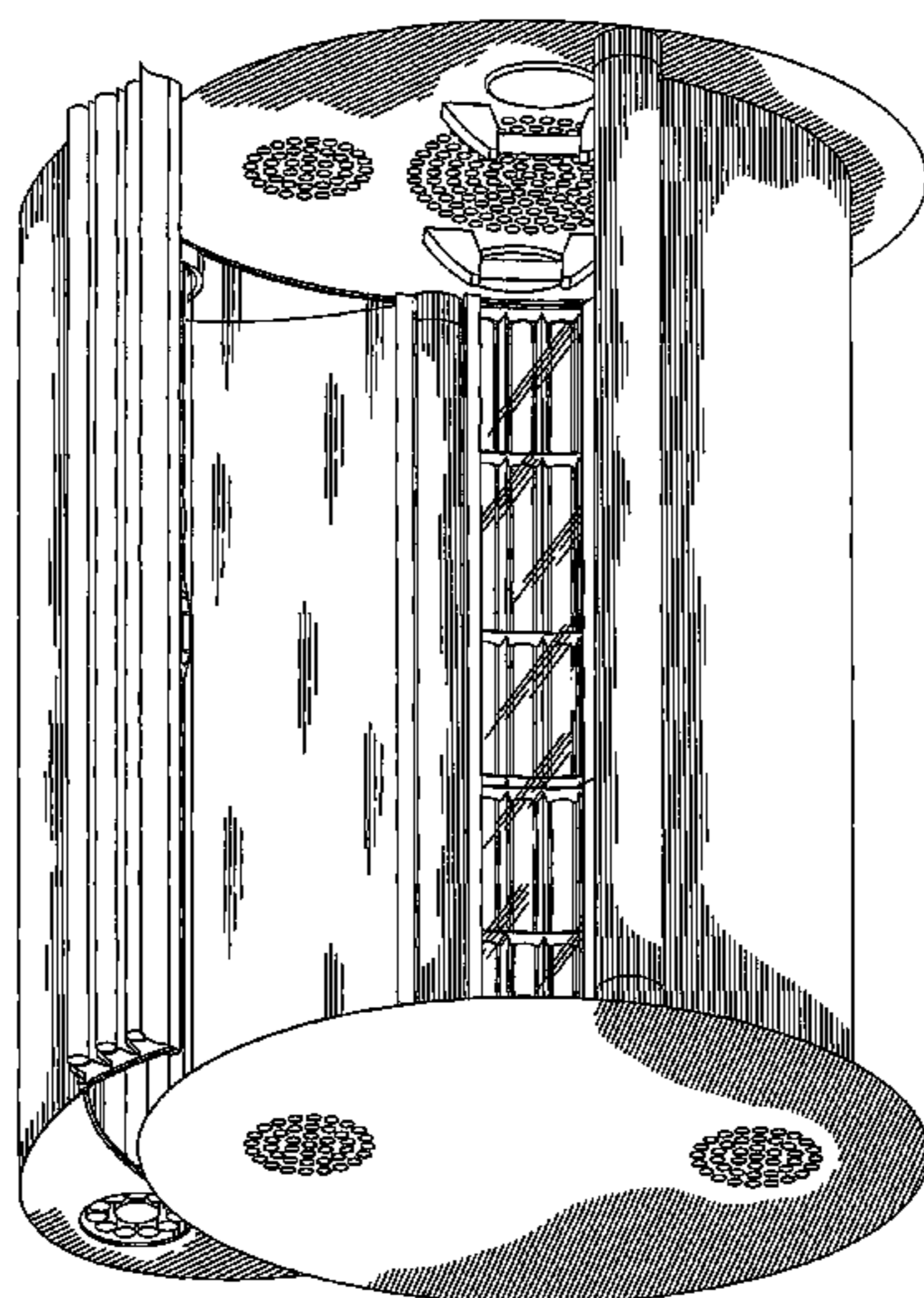

# US D711,544 S

Page 2

---

(56)

## References Cited

### U.S. PATENT DOCUMENTS

2007/0169261	A1 *	7/2007	Smith et al. ....	4/615			
2009/0211592	A1 *	8/2009	Waters et al. ....	132/200			
2010/0145529	A1 *	6/2010	Thomason et al. ....	700/283			
2010/0174222	A1 *	7/2010	McDaniel .....	604/20			
2013/0172963	A1 *	7/2013	Moffat .....	607/94			
2013/0282080	A1 *	10/2013	Hendrix et al. ....	607/88			

\* cited by examiner

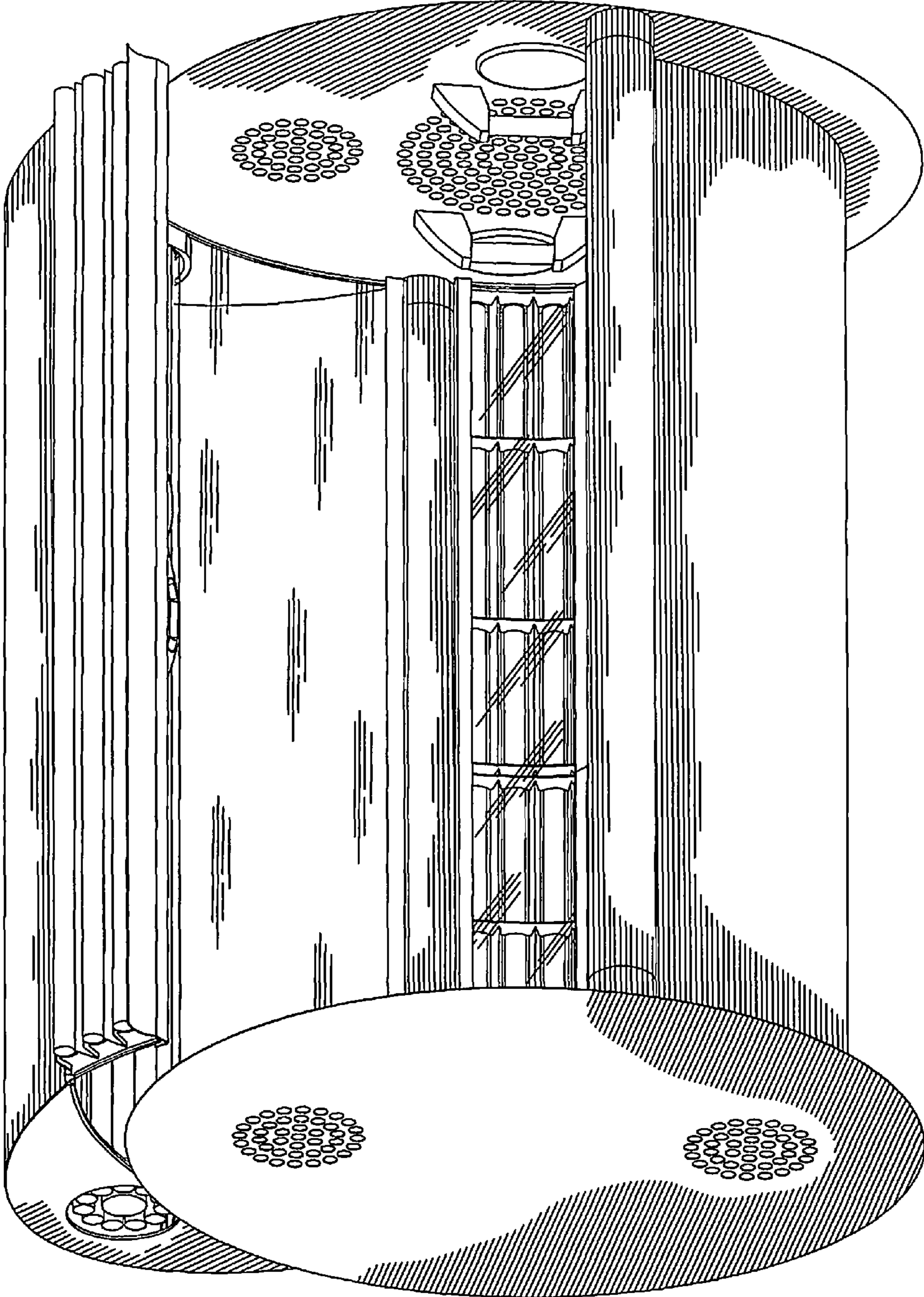

Figure 1

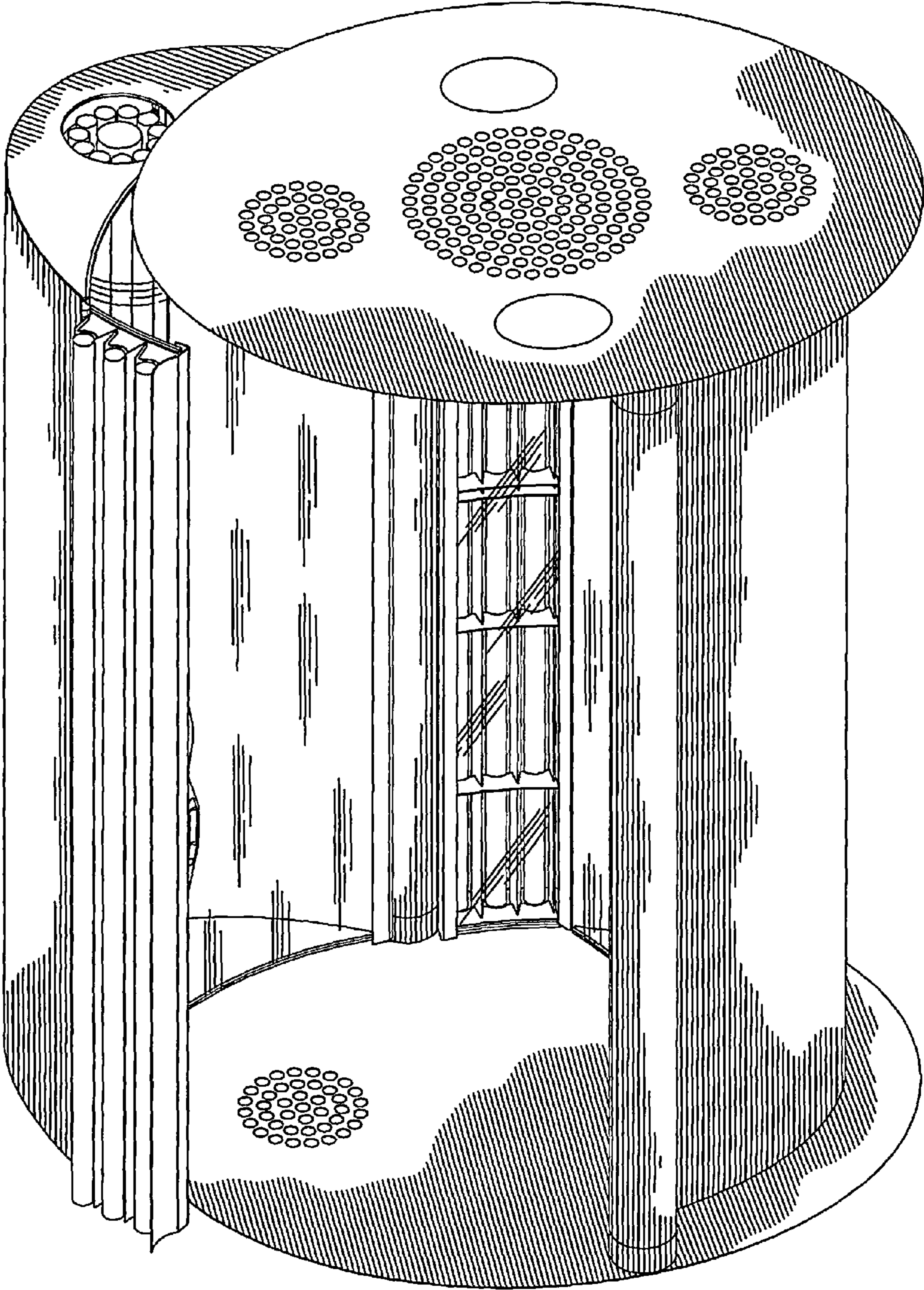

Figure 2

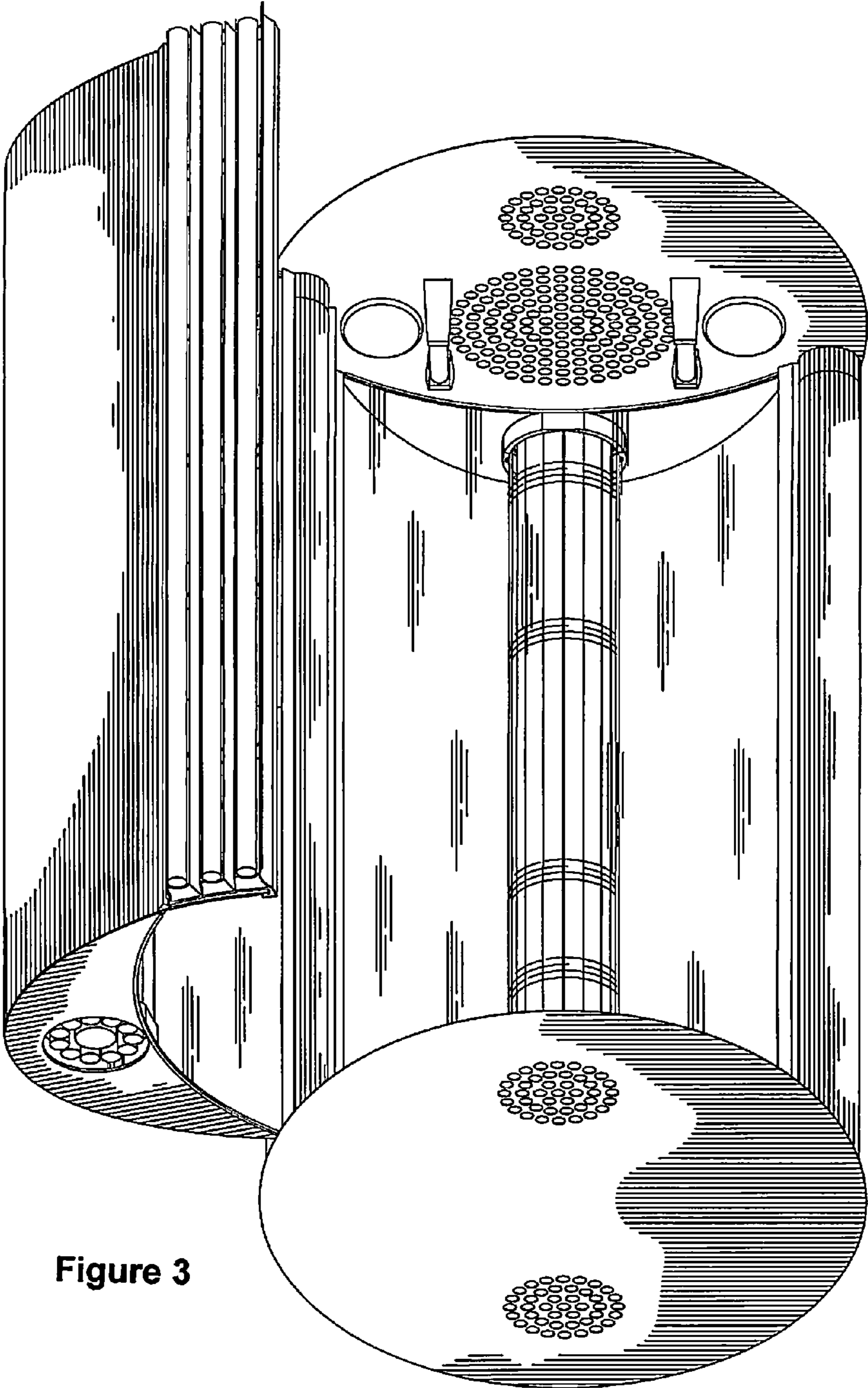

Figure 3

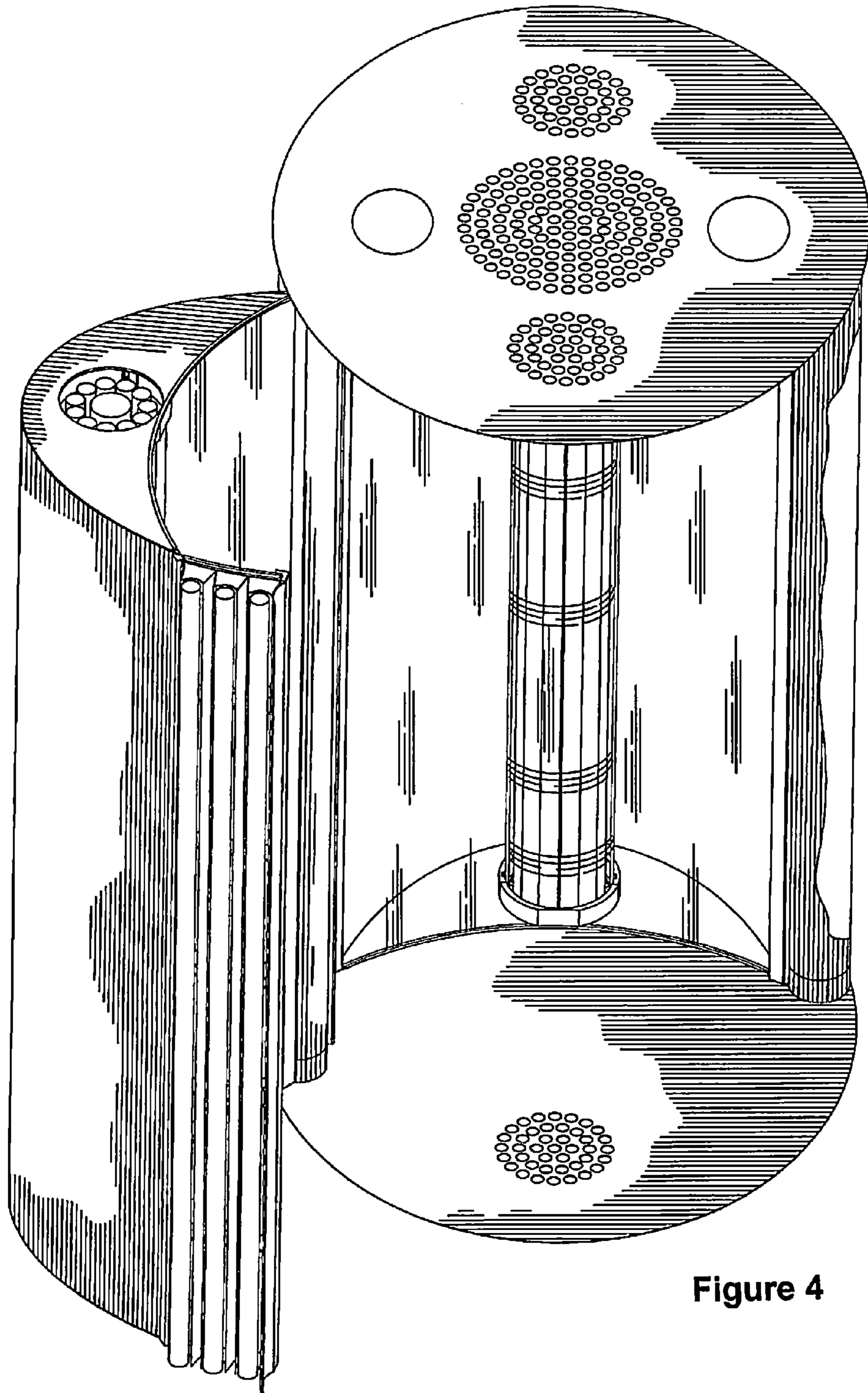

Figure 4

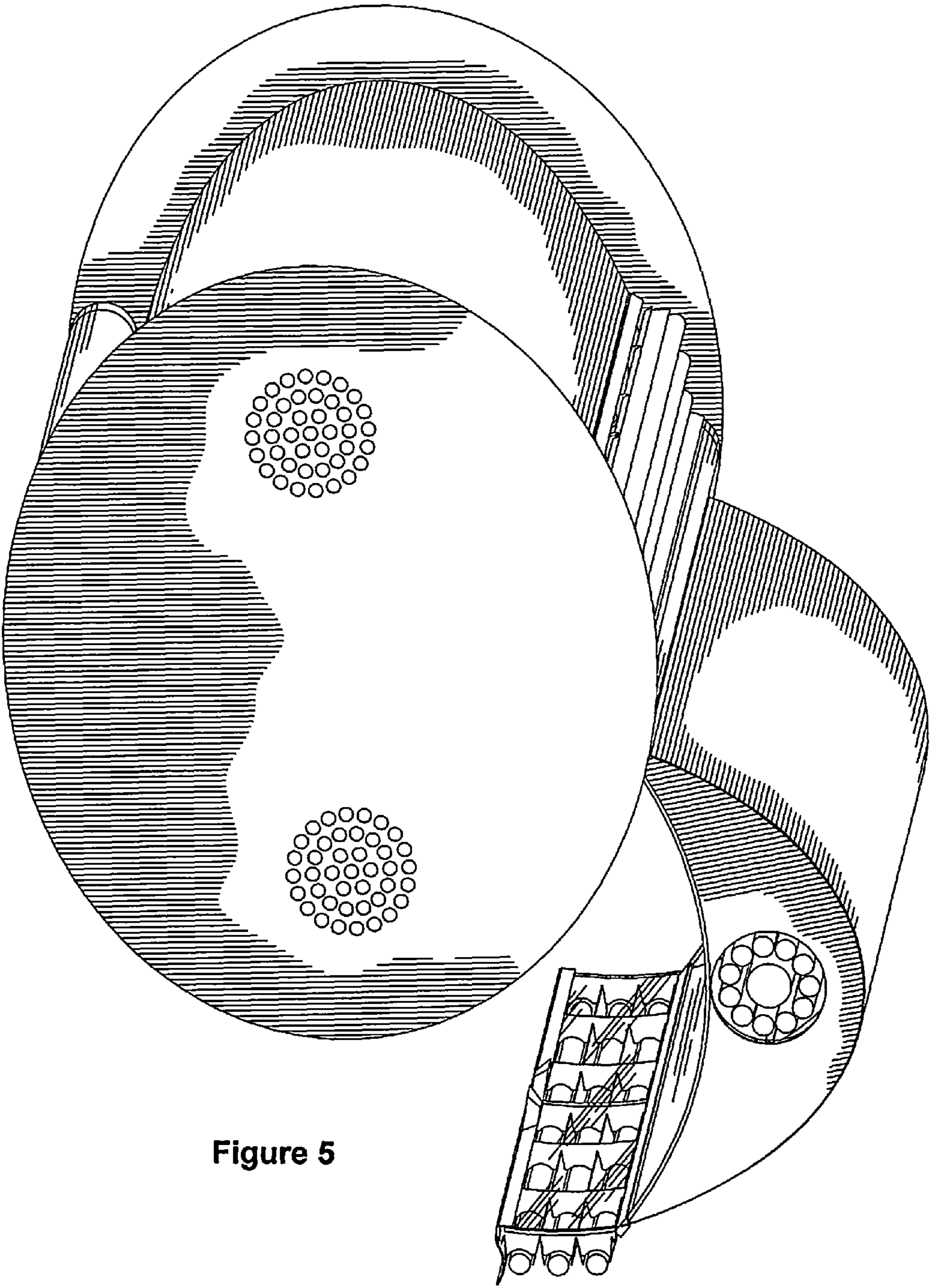

Figure 5

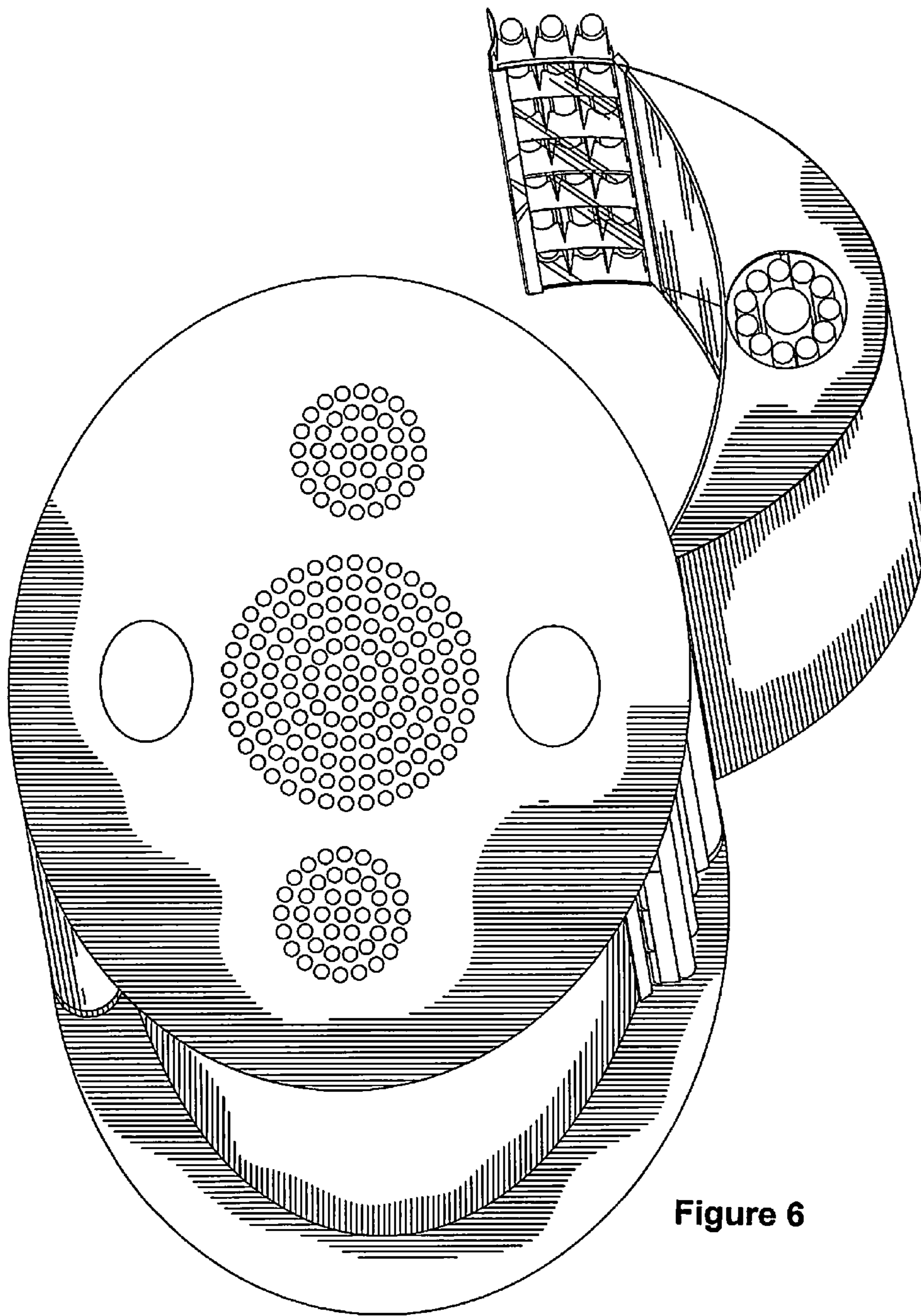

Figure 6



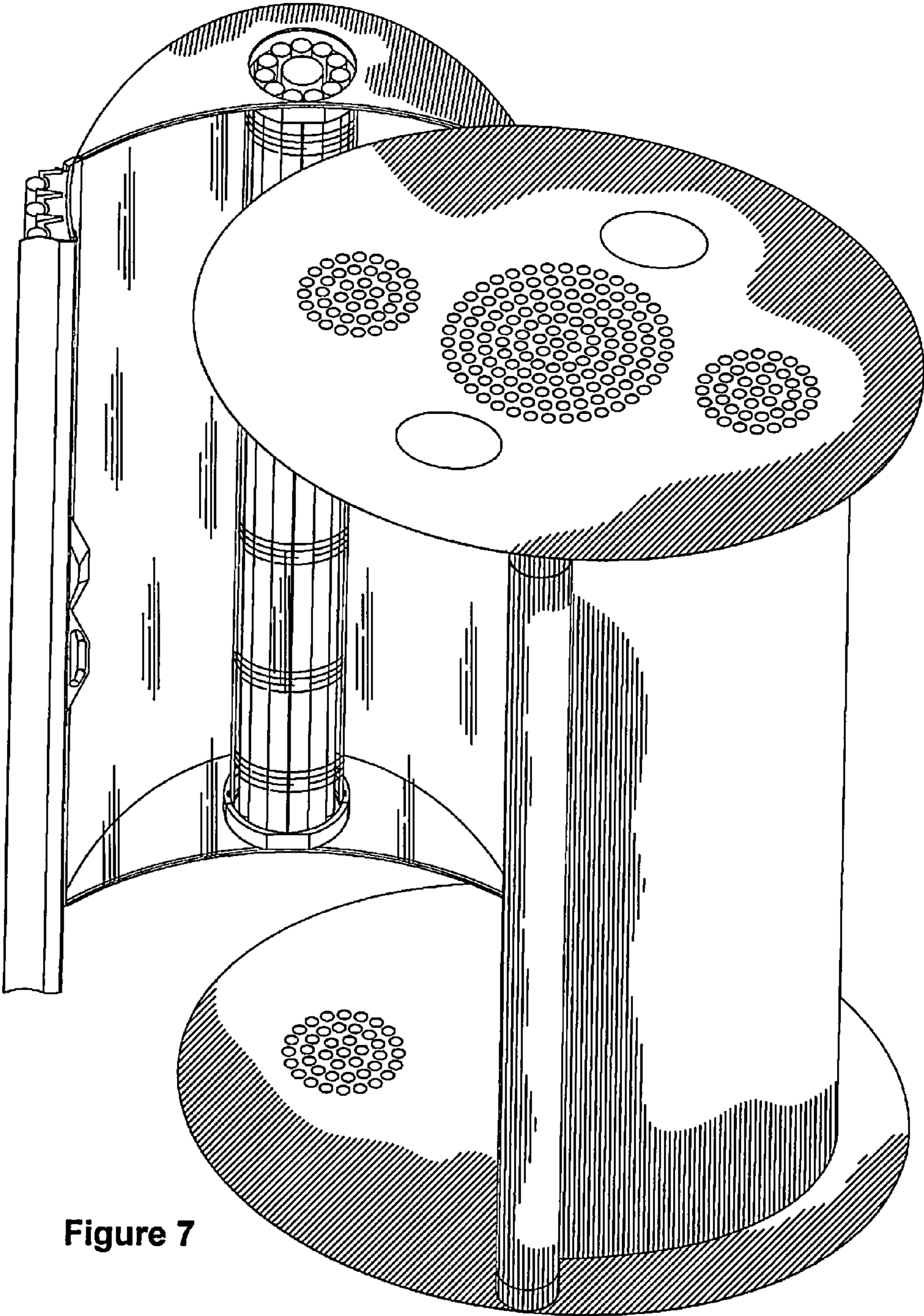

Figure 7

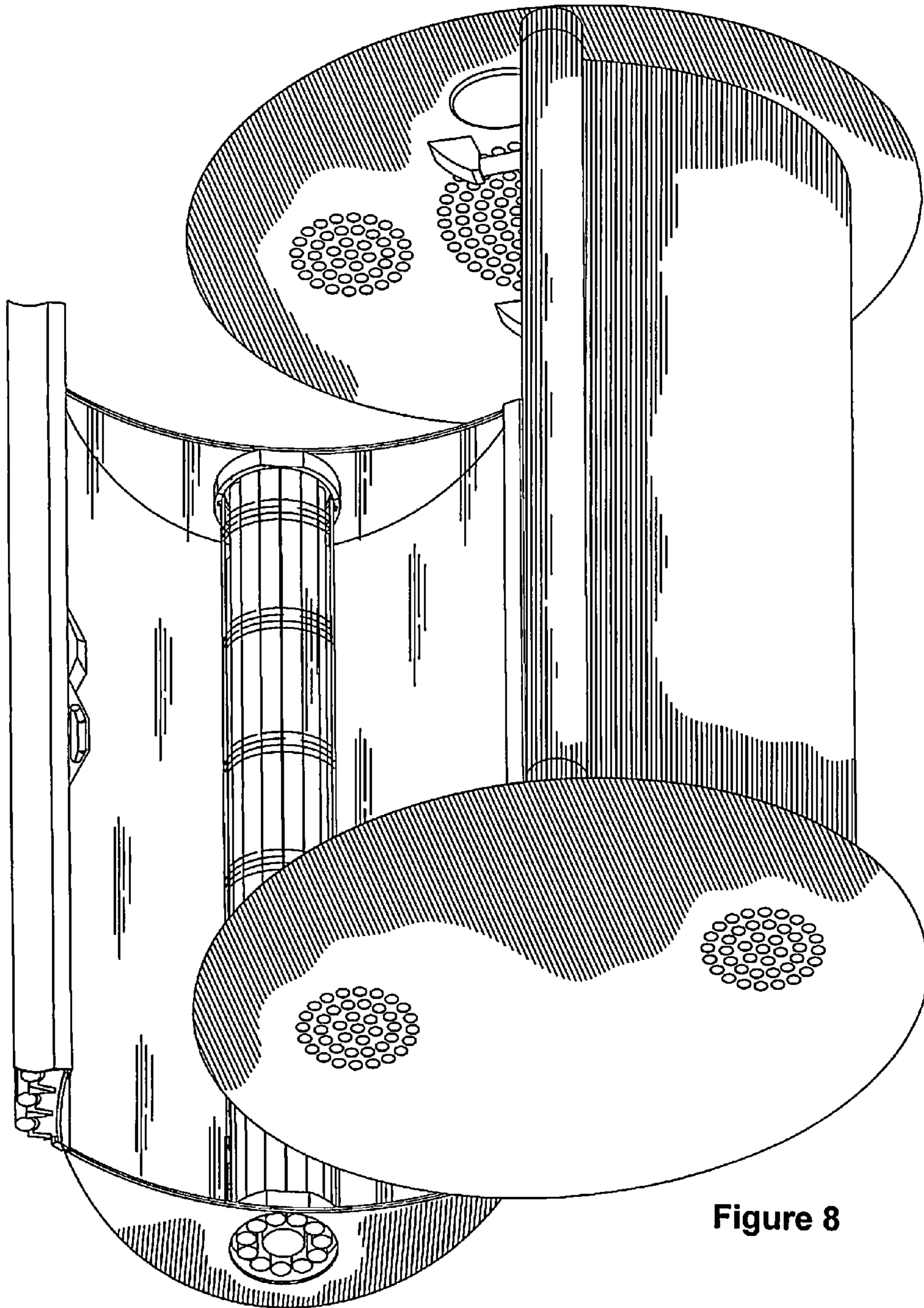

Figure 8

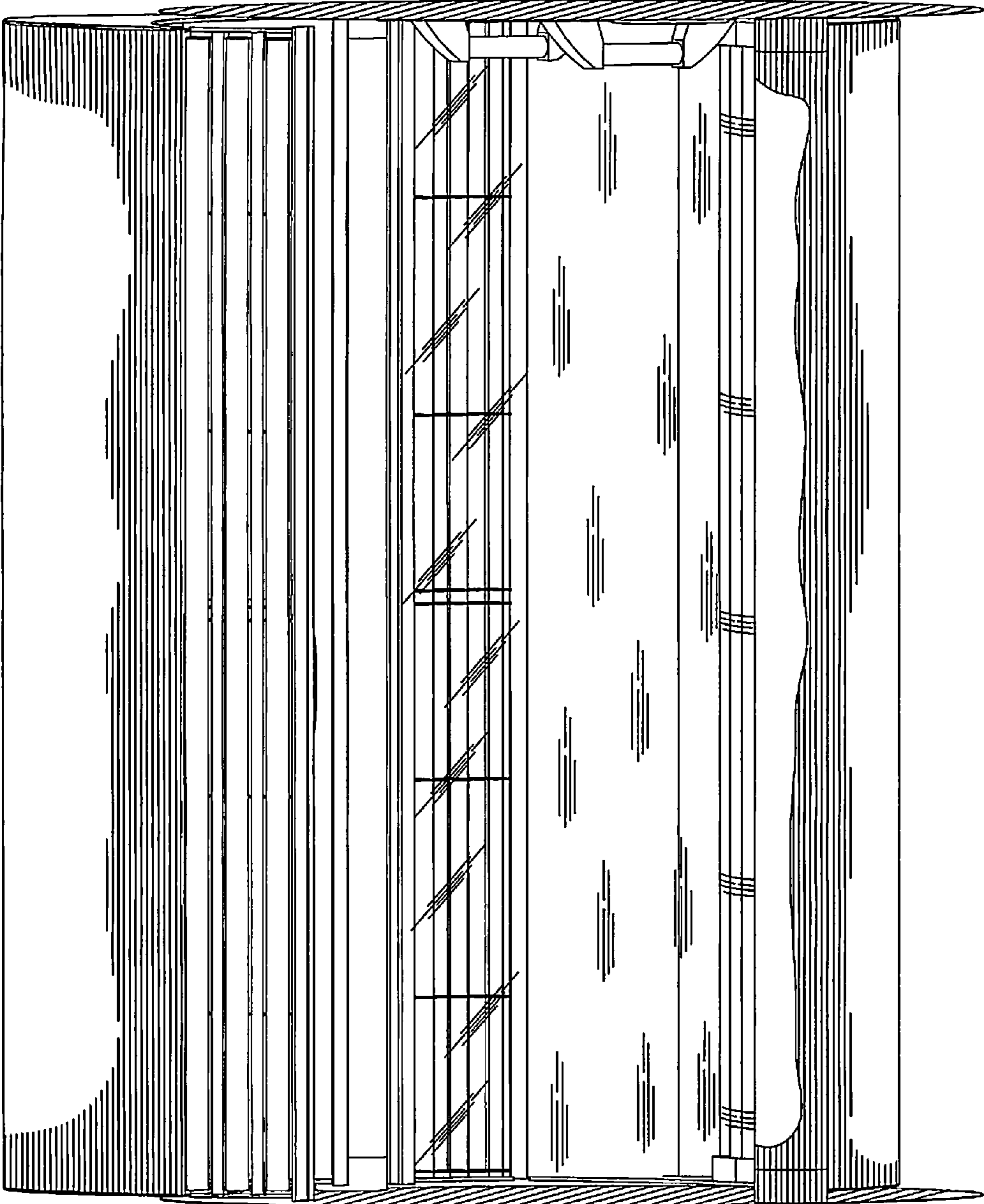

Figure 9

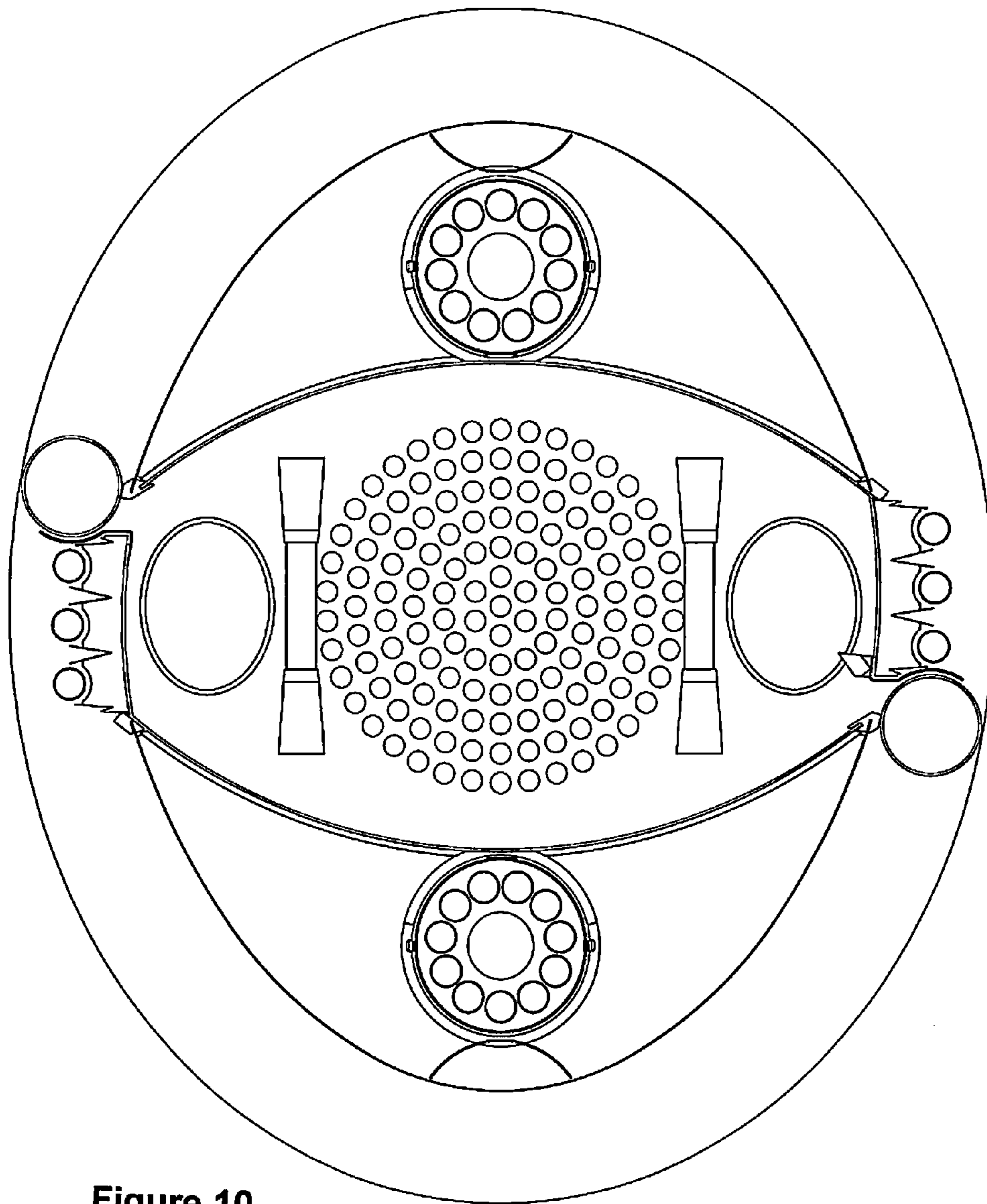

Figure 10

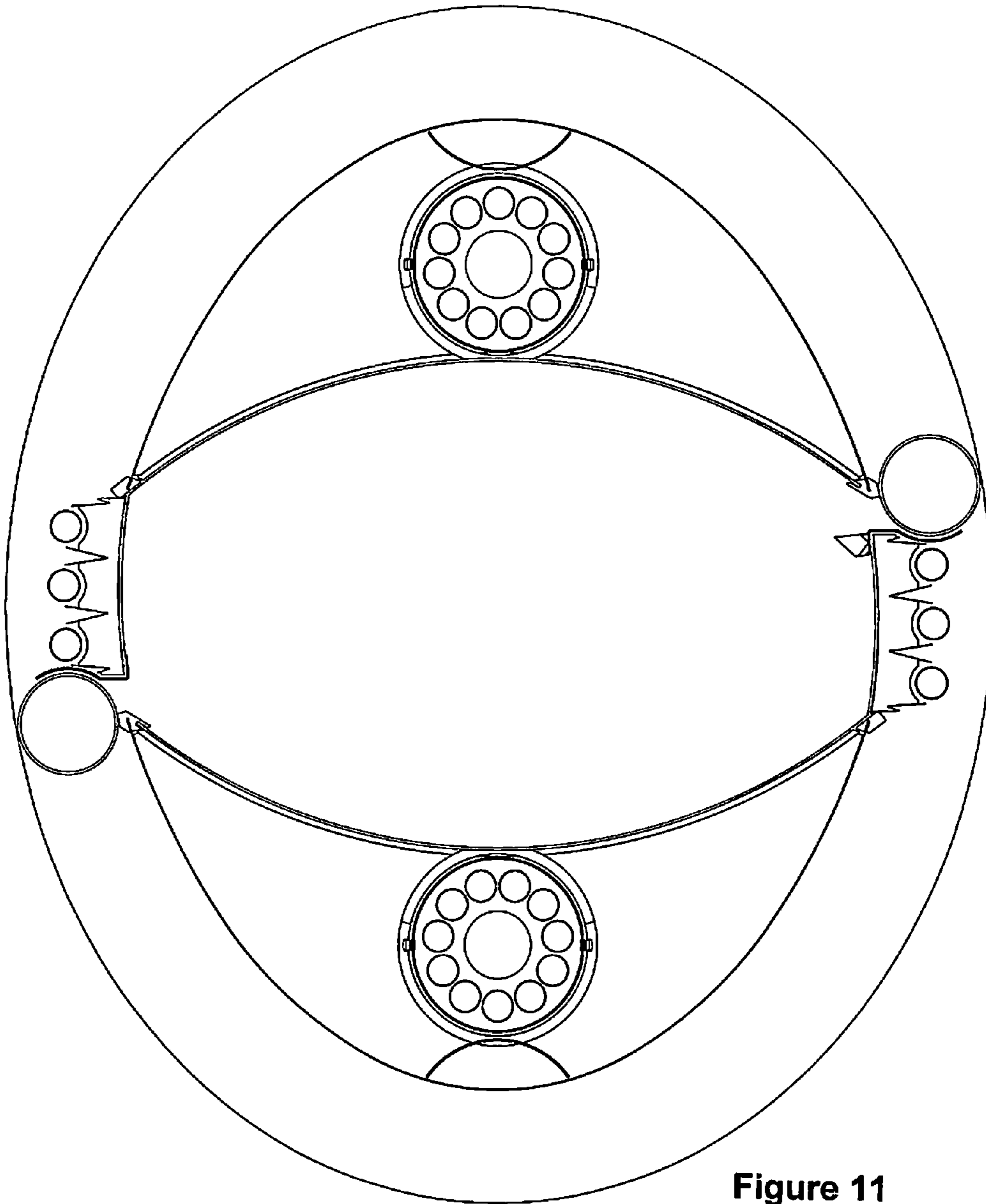

Figure 11

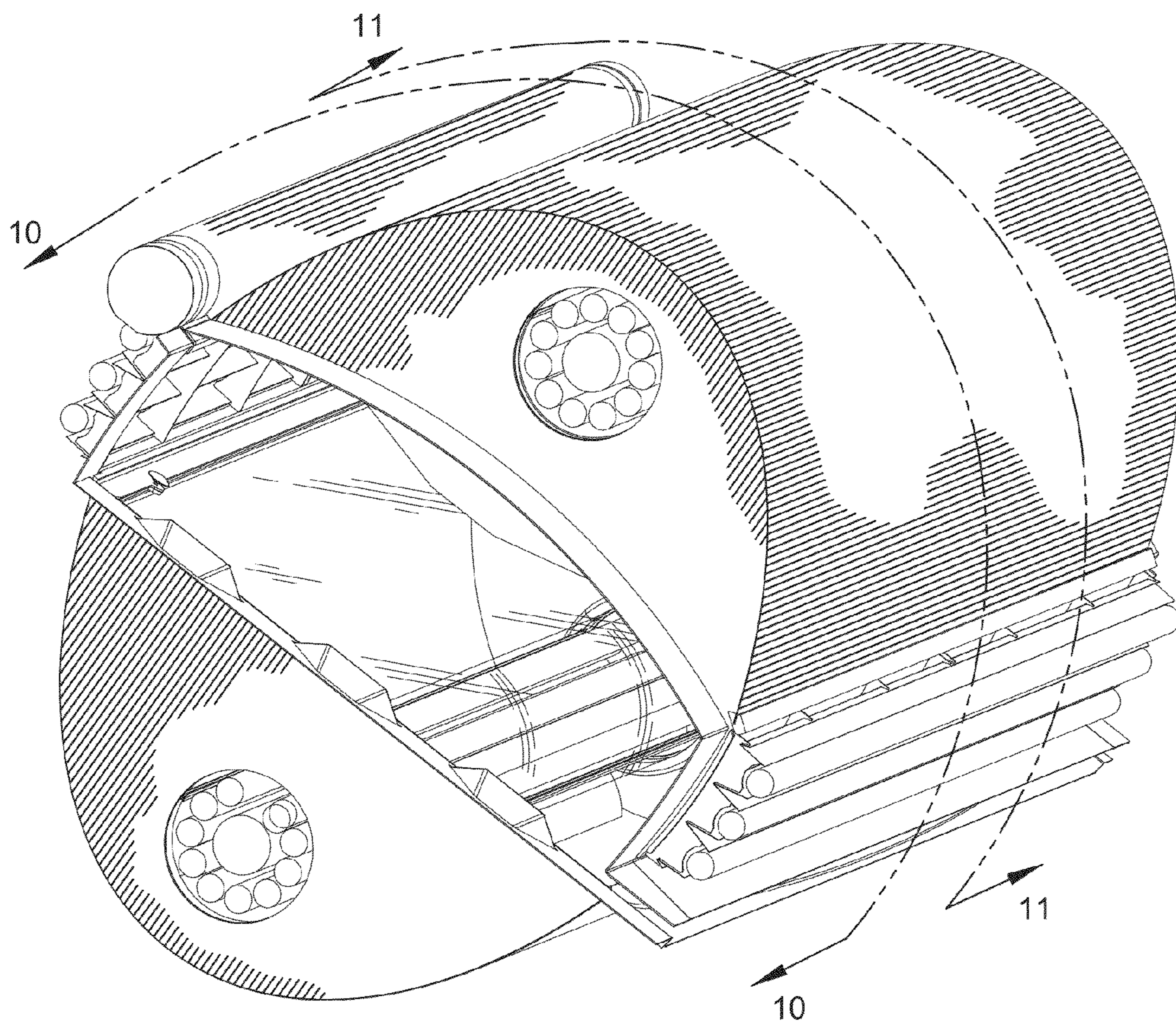

Figure 12