



US00D711485S

(12) **United States Design Patent**  
**Thompson**

(10) **Patent No.:** **US D711,485 S**

(45) **Date of Patent:** **\*\* Aug. 19, 2014**

(54) **TOY SURFBOARD**

(71) Applicant: **Toyosity, LLC**, Windermere, FL (US)

(72) Inventor: **Joe Lee Thompson**, Merritt Island, FL (US)

(\*\*) Term: **14 Years**

(21) Appl. No.: **29/447,627**

(22) Filed: **Mar. 5, 2013**

(51) **LOC (10) Cl.** ..... **21-02**

(52) **U.S. Cl.**  
USPC ..... **D21/769**

(58) **Field of Classification Search**  
USPC ..... D21/769-770, 801, 803, 809; 114/253,  
114/345-346; 441/35, 66, 74, 40-42,  
441/129-132; 472/128-129; D12/5, 6, 316  
See application file for complete search history.

(56) **References Cited**

U.S. PATENT DOCUMENTS

954,544	A	4/1910	Sanford	
1,399,855	A	12/1921	Fierlein	
3,160,897	A *	12/1964	Kelly, Jr.	441/74
3,721,038	A	3/1973	Viczena	
3,871,127	A	3/1975	Heath	
4,768,988	A	9/1988	Rutter	
4,802,429	A	2/1989	Butka	
4,857,025	A *	8/1989	Brown et al.	441/65
4,923,427	A	5/1990	Roland	
D312,491	S	11/1990	Roland	
4,968,273	A	11/1990	Momot	
5,069,648	A	12/1991	Ozeki	
D324,706	S	3/1992	Gibson	
D424,569	S	5/2000	Augusta	
D455,186	S *	4/2002	Koester	D21/769
6,692,321	B2	2/2004	Metrot	
6,699,091	B1	3/2004	Warner	
D496,491	S *	9/2004	Chen	D27/148

D498,559	S *	11/2004	Pan	D27/148
6,863,583	B2 *	3/2005	Takahashi	441/74
D515,684	S *	2/2006	Latone	D23/366
D560,030	S *	1/2008	Welch	D27/148

\* cited by examiner

*Primary Examiner* — Zenia Bennett

(57) **CLAIM**

The ornamental design for a toy surfboard, as shown and described.

**DESCRIPTION**

FIG. 1 is a top rear perspective view of the toy surfboard.  
 FIG. 2 is a top front right perspective view of the toy surfboard of FIG. 1.  
 FIG. 3 is a top front left perspective view of the toy surfboard of FIG. 1.  
 FIG. 4 is a top rear left perspective view of the toy surfboard of FIG. 1.  
 FIG. 5 is a bottom front left perspective view of the toy surfboard of FIG. 1.  
 FIG. 6 is a bottom rear right perspective view of the toy surfboard of FIG. 1.  
 FIG. 7 is a bottom rear left perspective view of the toy surfboard of FIG. 1.  
 FIG. 8 is bottom front left perspective view of the toy surfboard of FIG. 1.  
 FIG. 9 is a right side view of the toy surfboard of FIG. 1.  
 FIG. 10 is a left side view of the toy surfboard of FIG. 1.  
 FIG. 11 is a top view of the toy surfboard of FIG. 1.  
 FIG. 12 is a bottom view of the toy surfboard of FIG. 1.  
 FIG. 13 is a rear end view of the toy surfboard of FIG. 1; and,  
 FIG. 14 is a front end view of the toy surfboard of FIG. 1.  
 The broken lines in FIGS. 1-14 are for illustrative purposes and form no part of the claimed design.

**1 Claim, 13 Drawing Sheets**

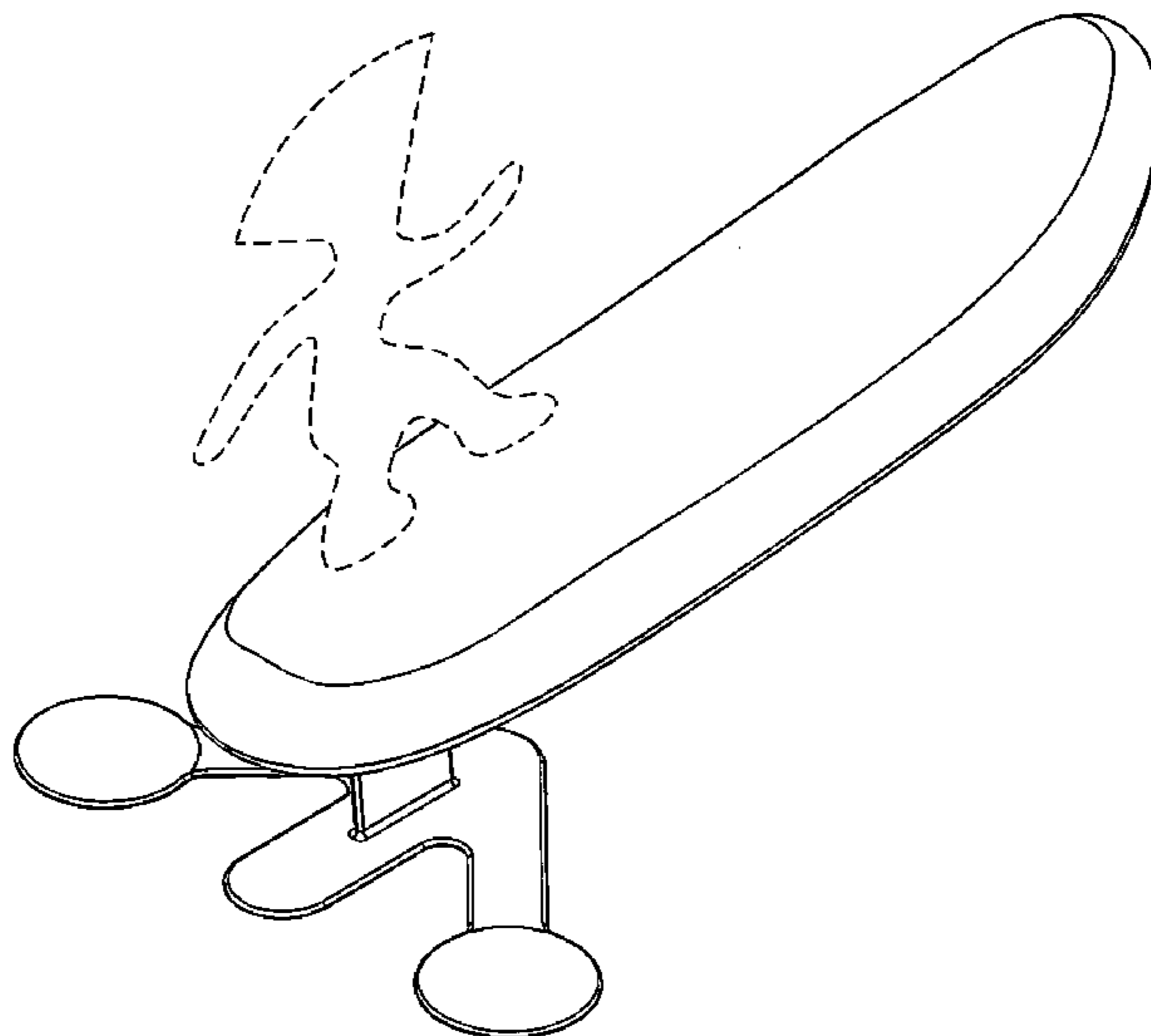

FIG. 1

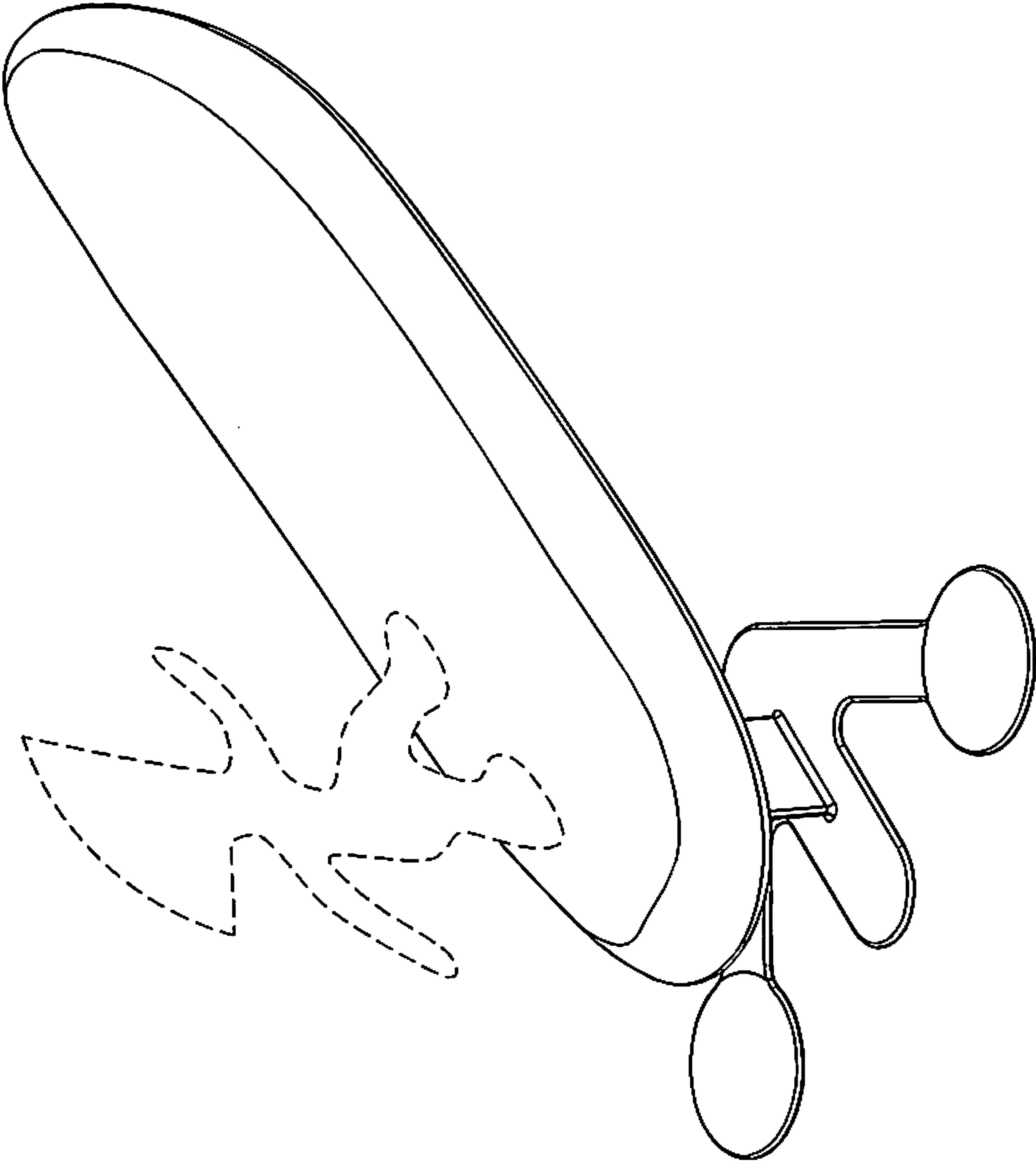

FIG. 2

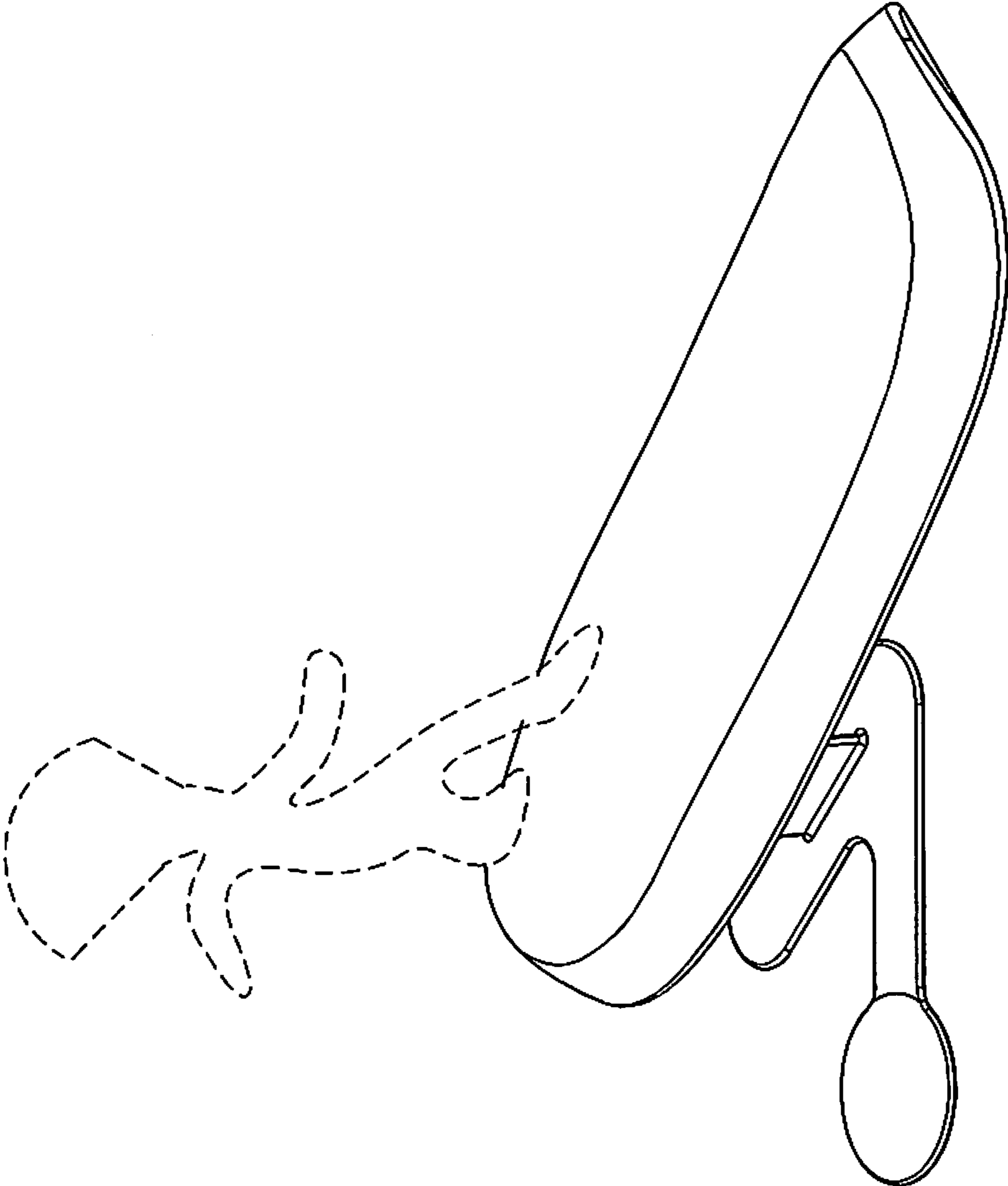

FIG. 3

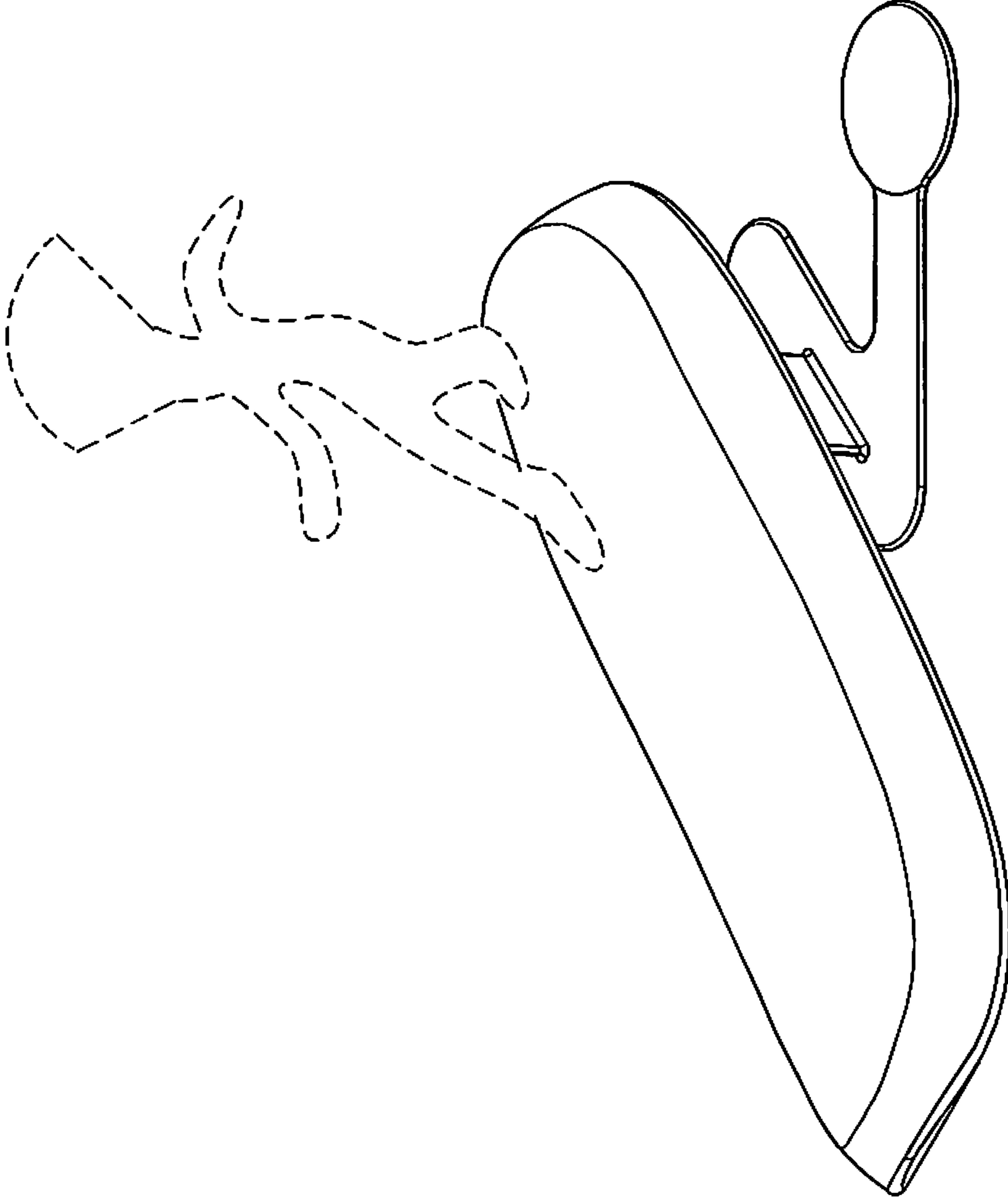

FIG. 4

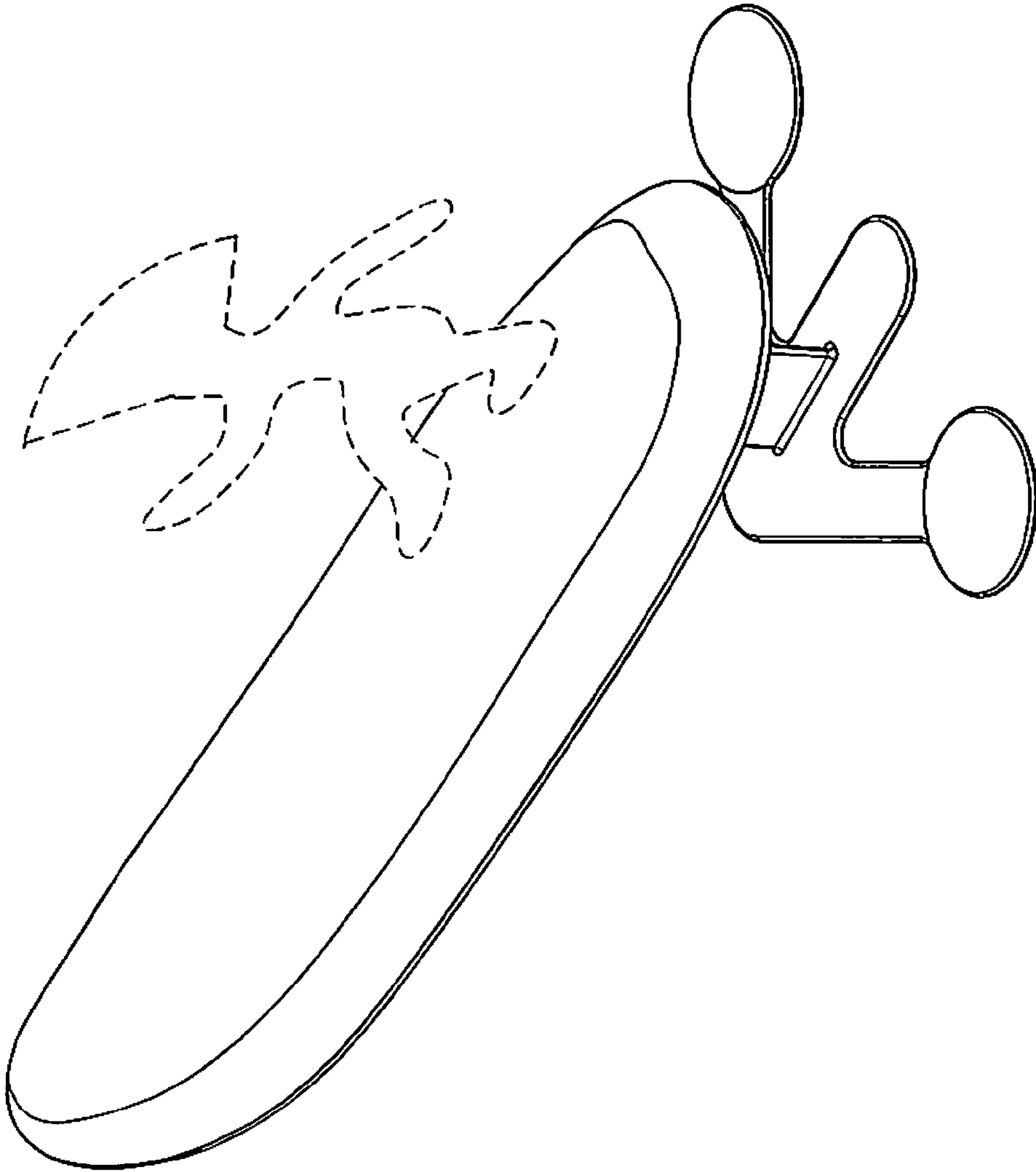

FIG. 5

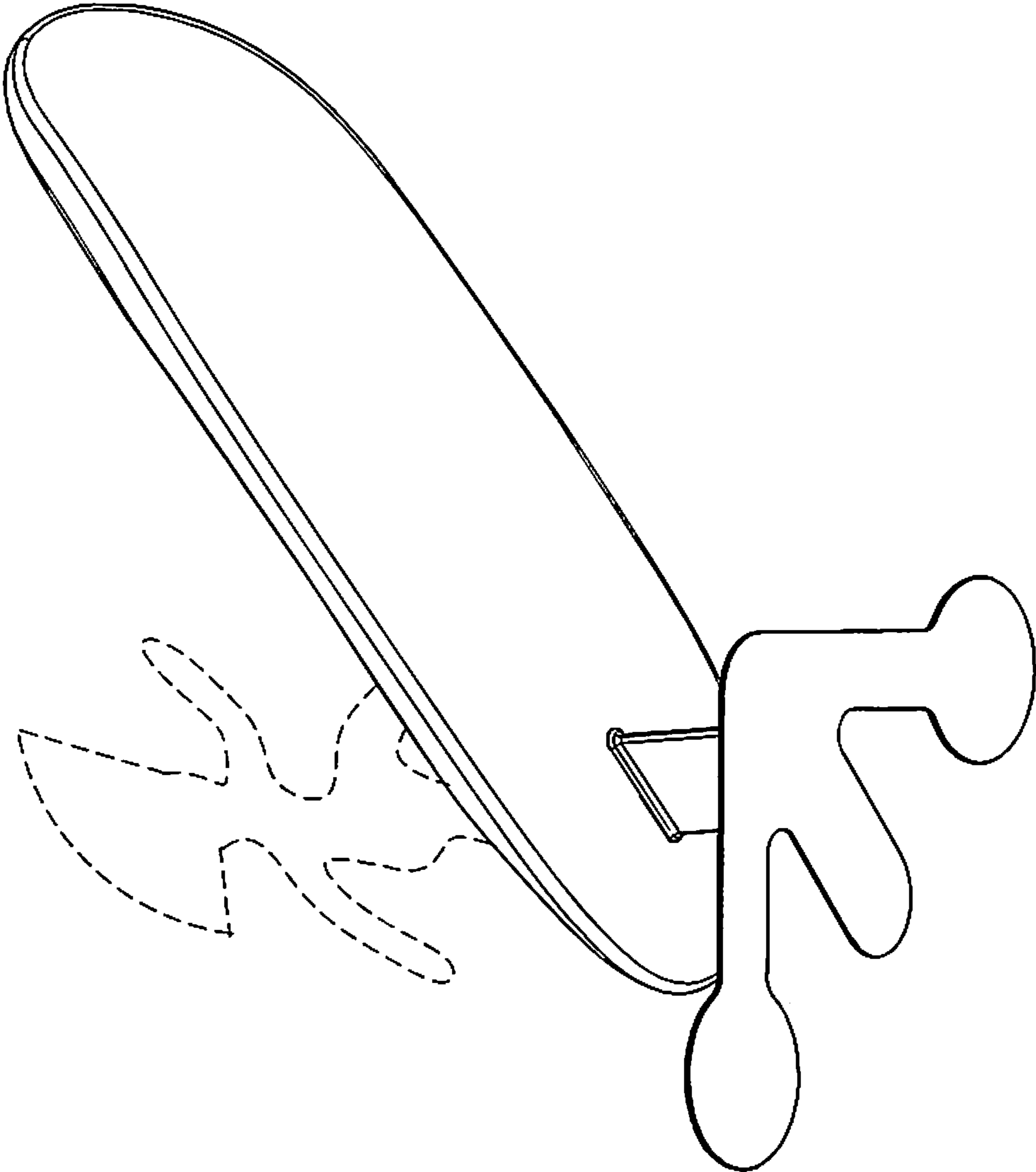

FIG. 6

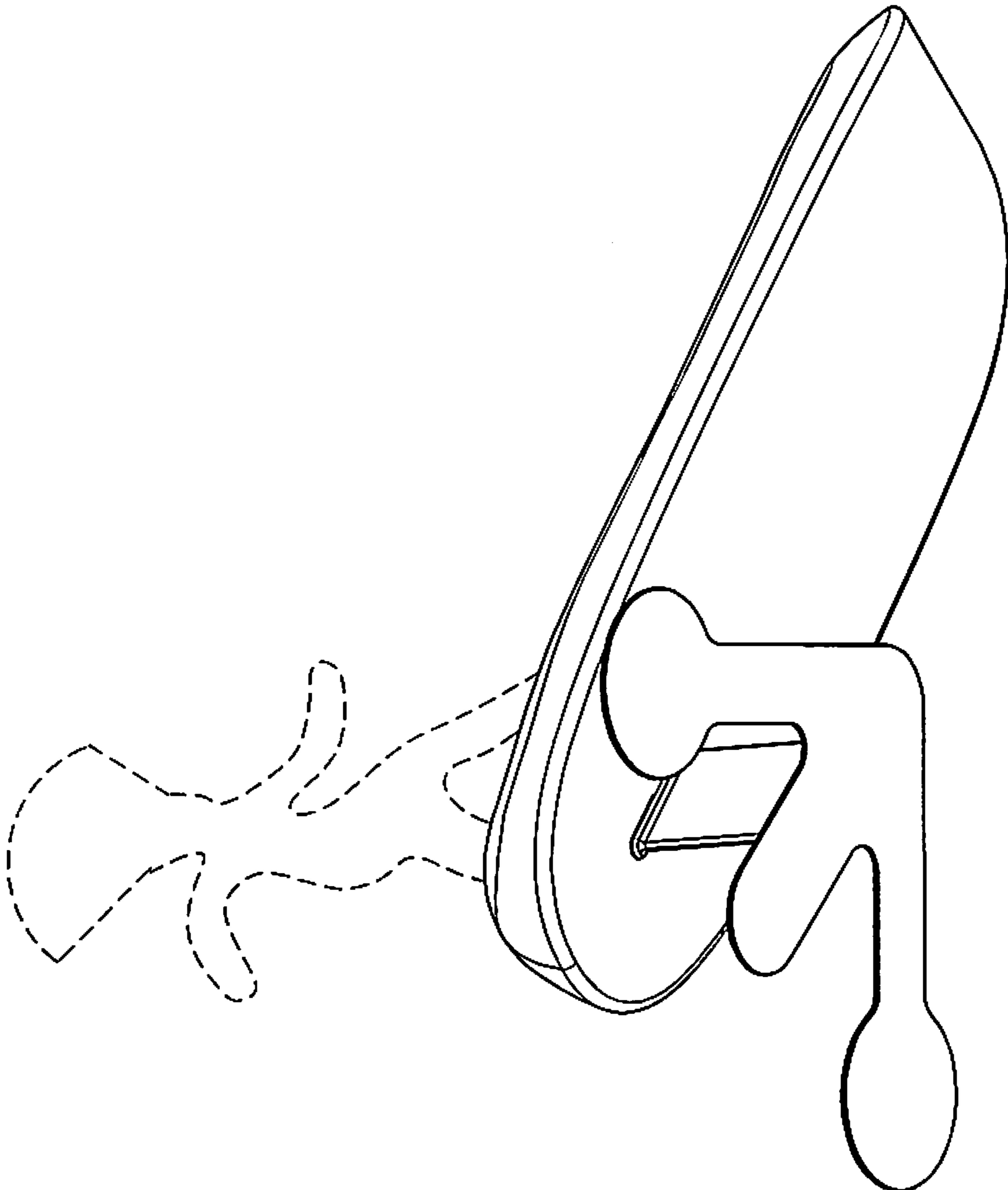

FIG. 7

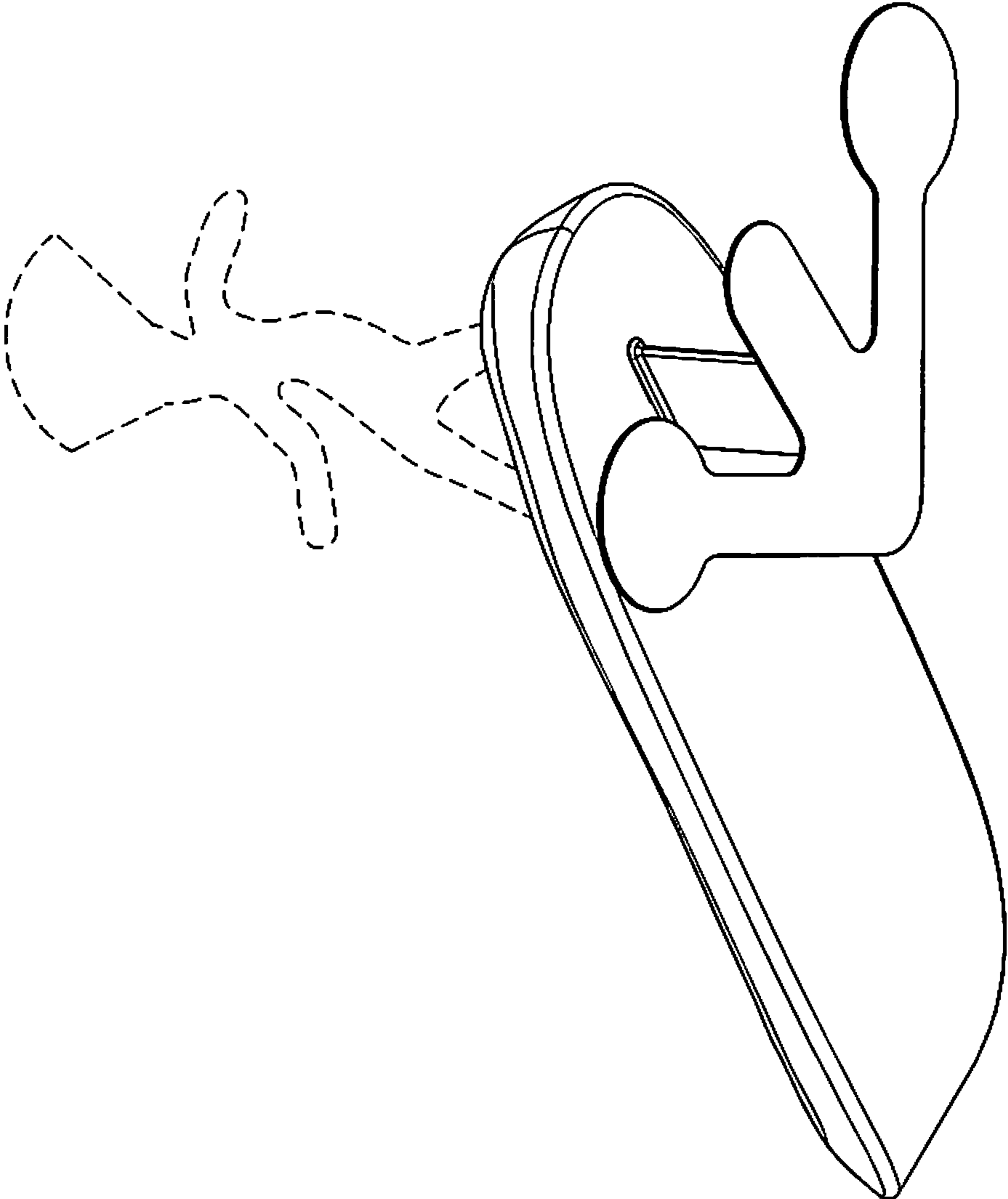



FIG. 8

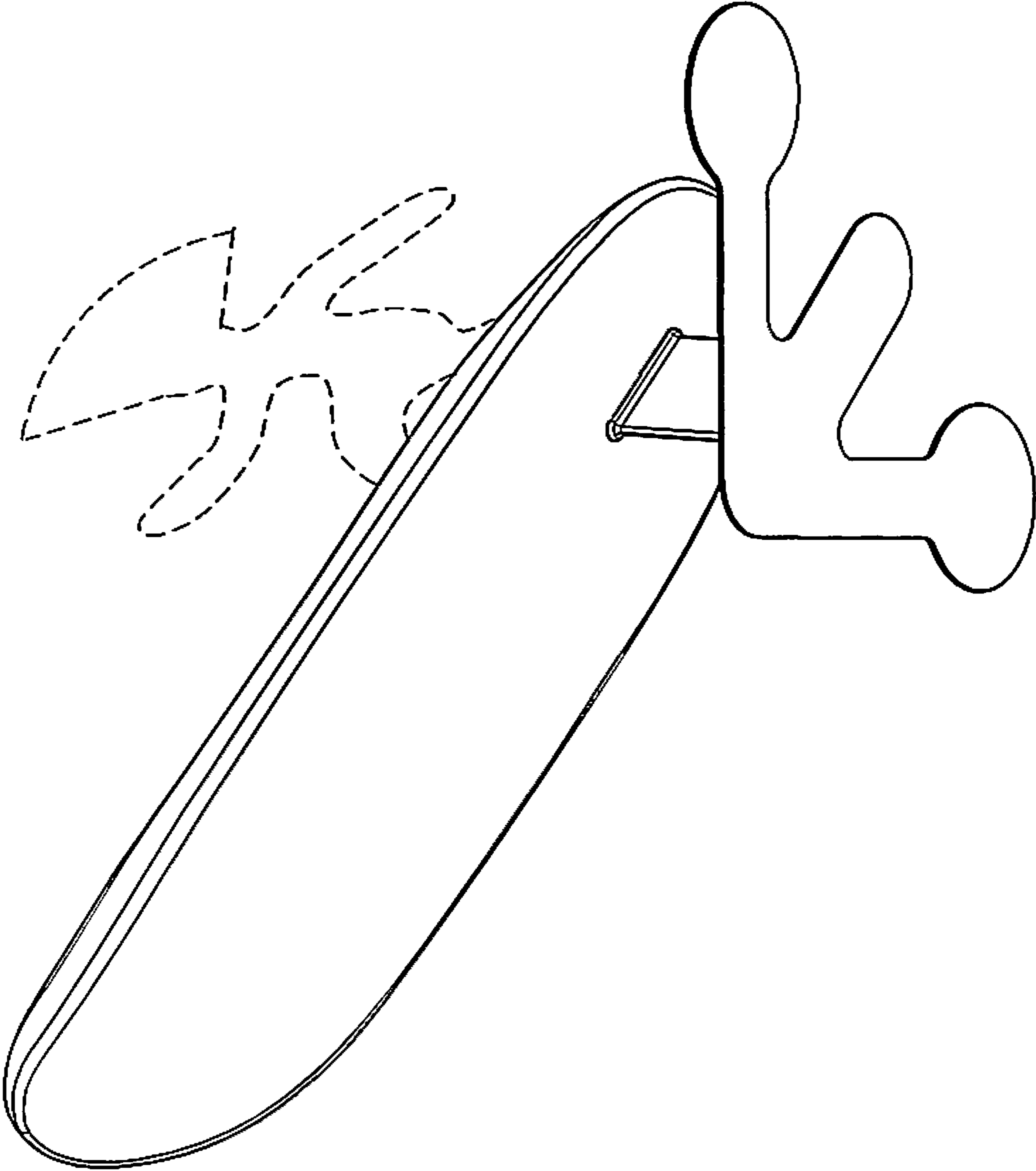

FIG. 9

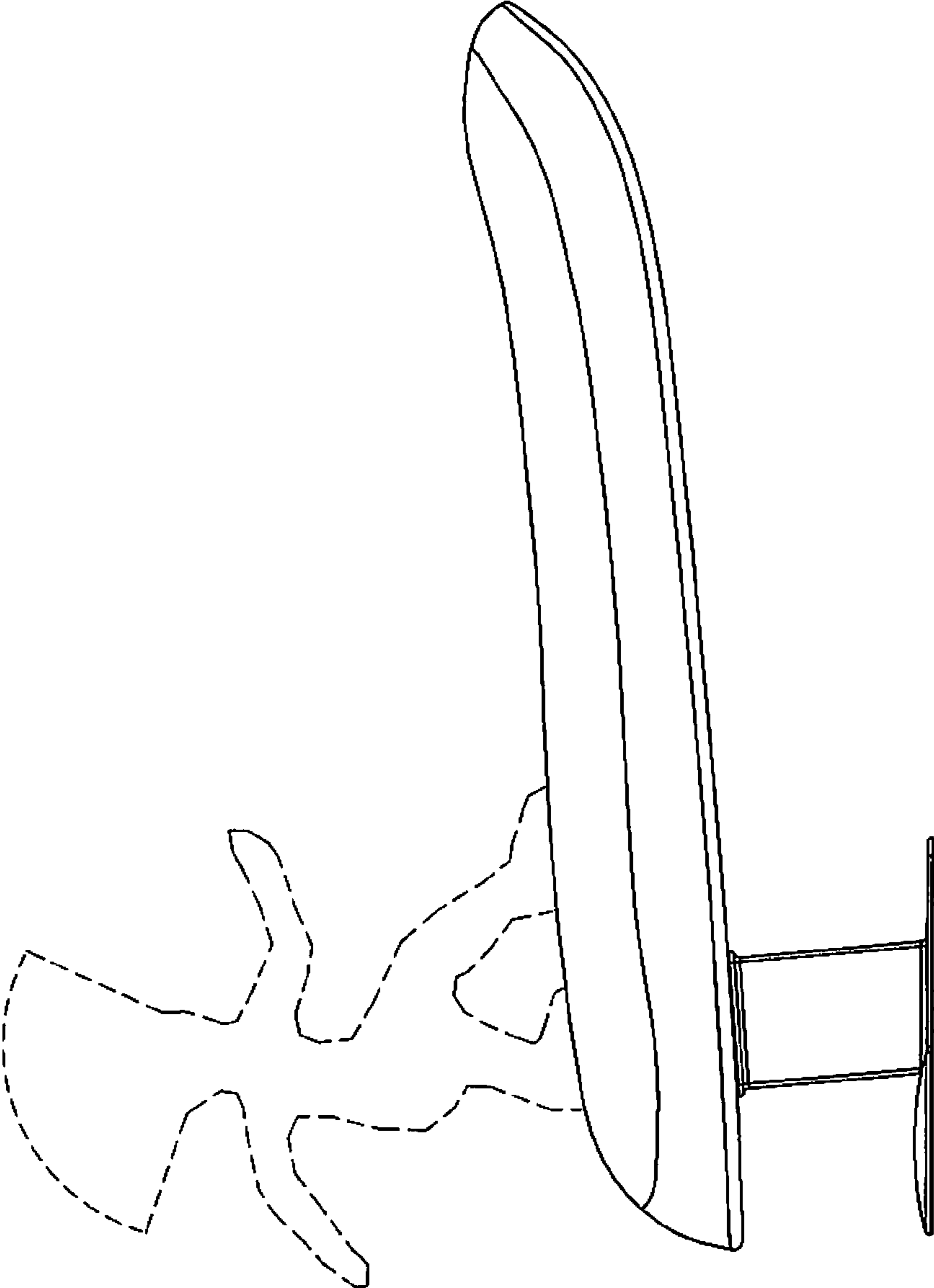

FIG. 10

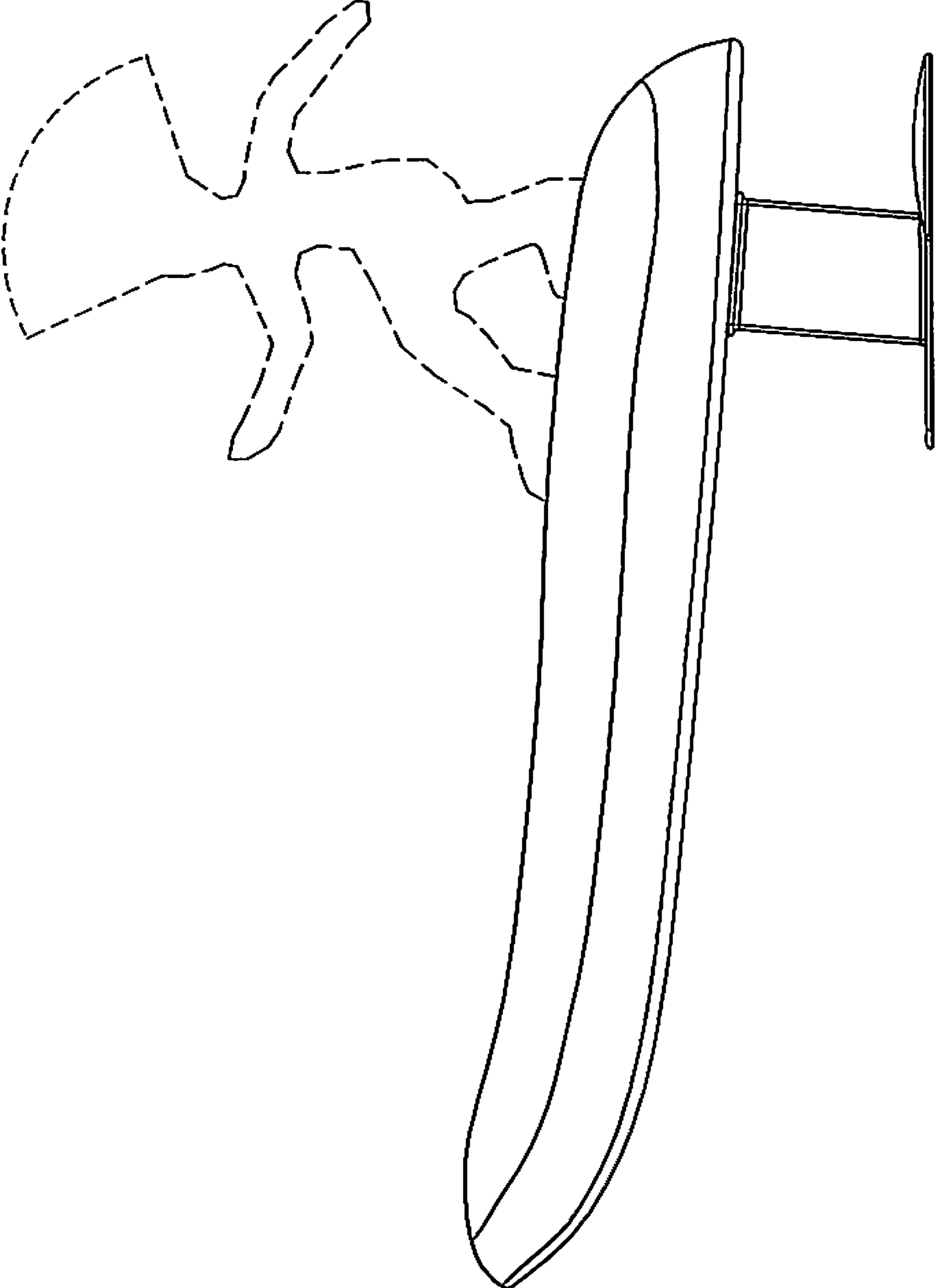

FIG. 11

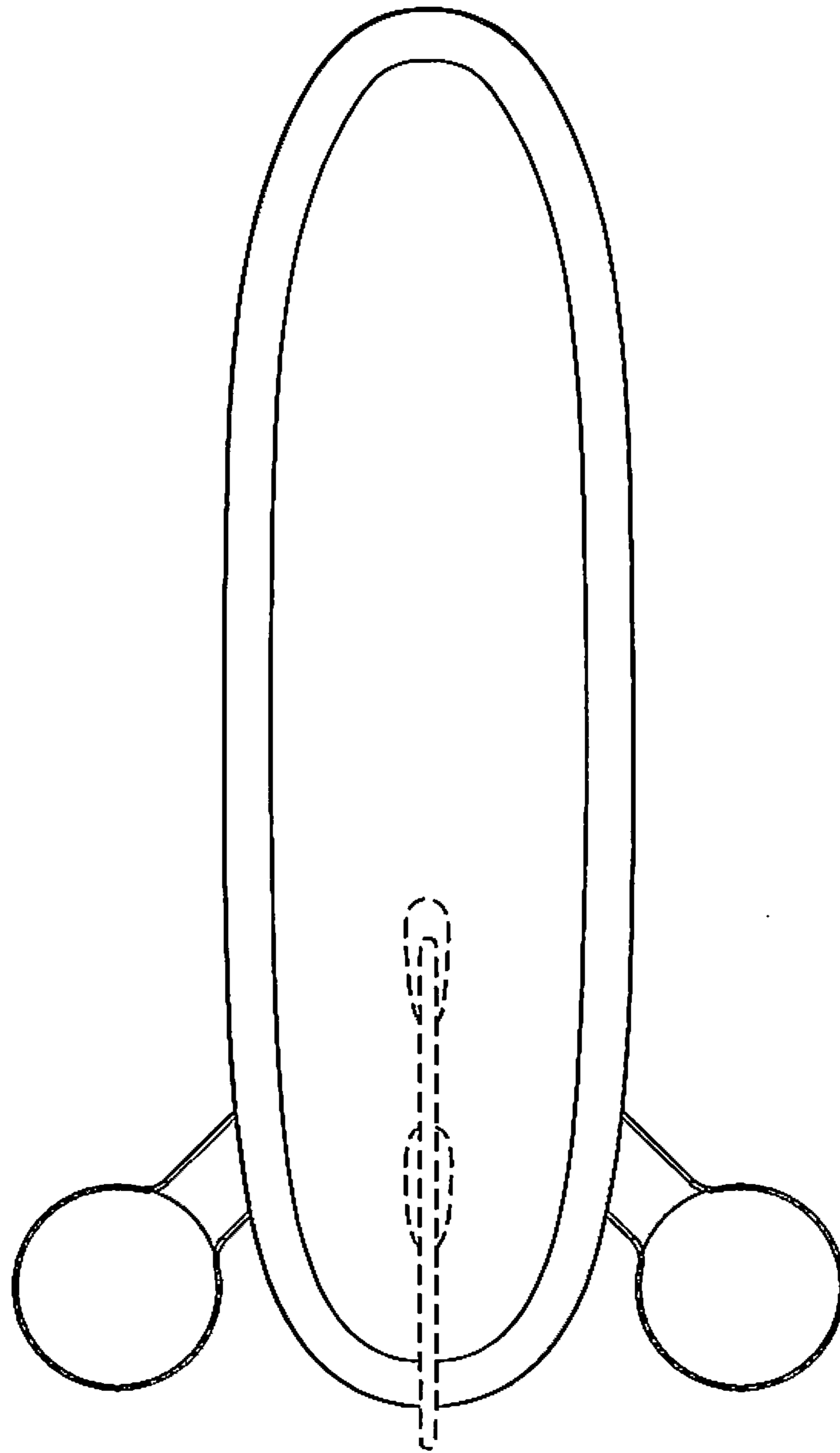

FIG. 12

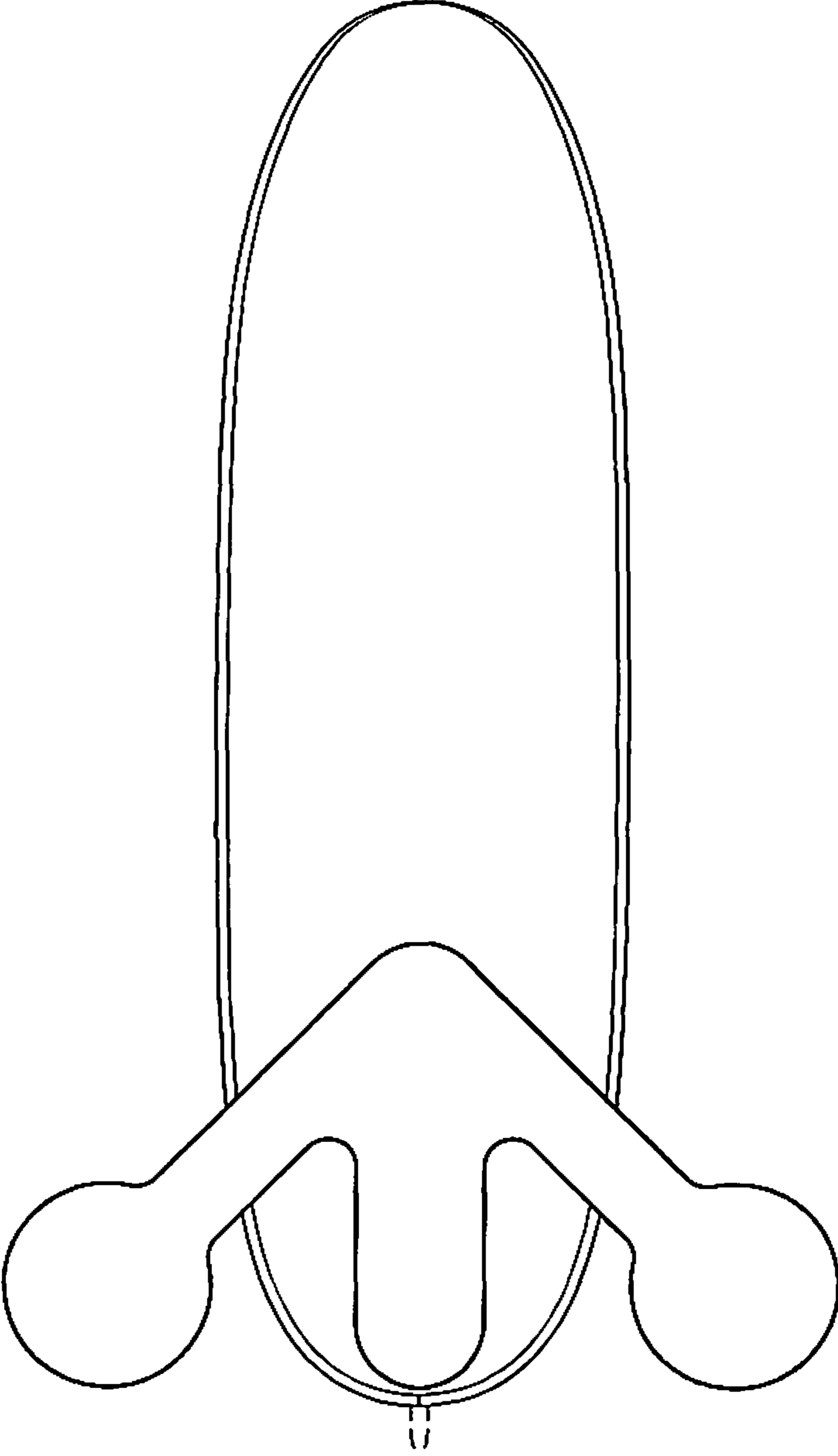

FIG. 14

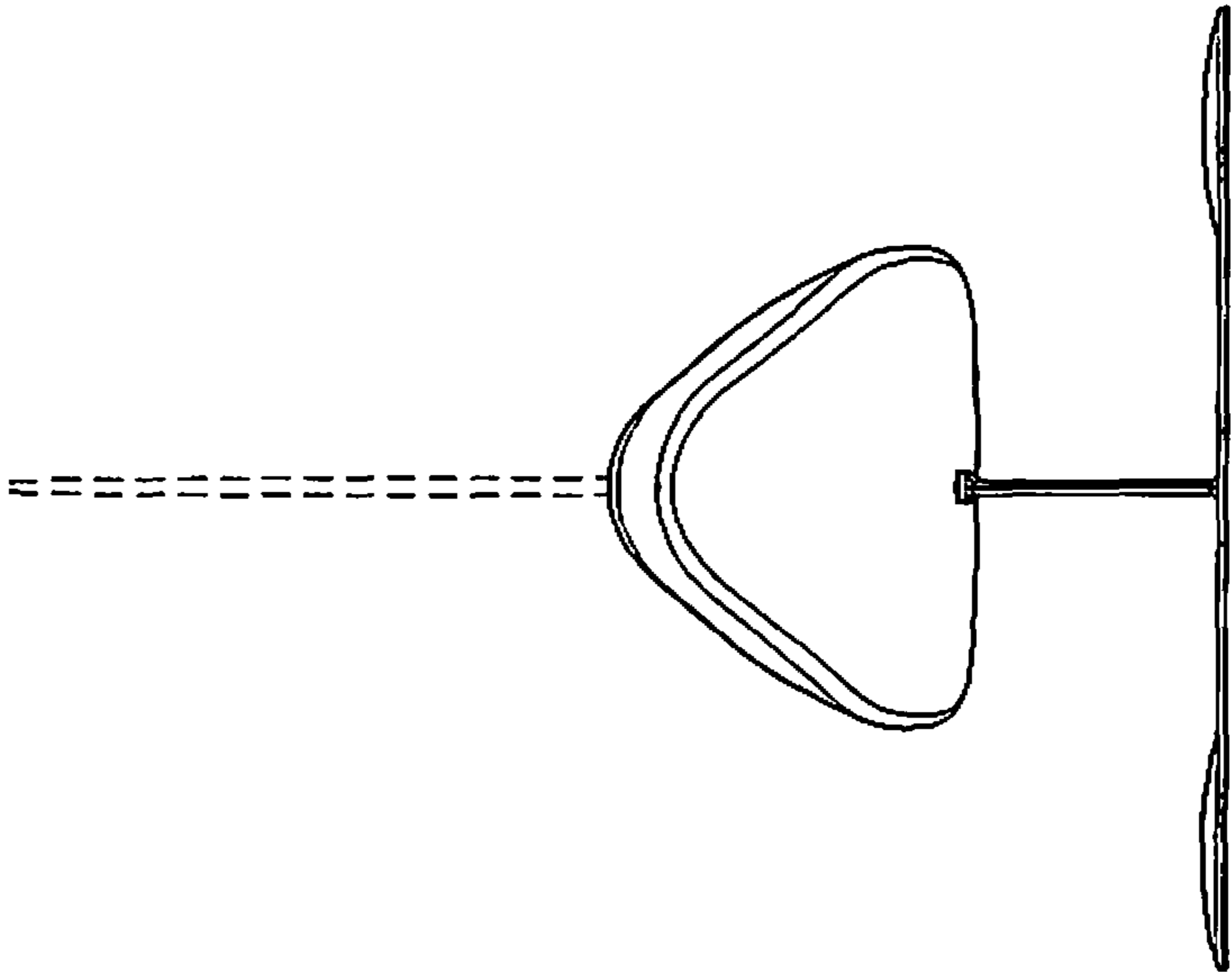

FIG. 13

