



US00D711371S

(12) **United States Design Patent**
Chen et al.

(10) **Patent No.:** **US D711,371 S**

(45) **Date of Patent:** **** Aug. 19, 2014**

(54) **TABLET COMPUTER**

(71) Applicant: **Quanta Computer Inc.**, Taoyuan Shien (TW)

(72) Inventors: **Jyun-Jie Chen**, Changhua County (TW); **Shih-Yun Lee**, New Taipei (TW); **Jung-Wen Chang**, Taoyuan County (TW)

(73) Assignee: **Quanta Computer Inc.**, Taoyuan Shien (TW)

(**) Term: **14 Years**

(21) Appl. No.: **29/450,289**

(22) Filed: **Mar. 15, 2013**

(30) **Foreign Application Priority Data**

Jan. 7, 2013 (TW) 102300163

(51) **LOC (10) Cl.** **14-02**

(52) **U.S. Cl.**
USPC **D14/341**

(58) **Field of Classification Search**
USPC D14/341-347, 137, 138 R, 138 AA, D14/138 C, 138 G, 496, 203.1, 203.3, 203.4, D14/203.7, 129, 130, 147, 218, 248, 389, D14/388, 426, 420; D10/65, 104.1; D18/6-7; D21/324, 329, 330; 455/556.1, 556.2, 566, 575.1, 90.3; 379/433.04, 433.01, 433.06, 916; 345/173, 901, 905; 361/679.26, 679.3, 361/679.55, 679.56

See application file for complete search history.

(56) **References Cited**

U.S. PATENT DOCUMENTS

D424,068 S * 5/2000 Takemasa D14/374
D639,763 S * 6/2011 Kim et al. D14/138 G

D639,767 S * 6/2011 Finney et al. D14/138 G
D641,017 S * 7/2011 Meng D14/341
D650,381 S * 12/2011 Park et al. D14/341
D652,418 S * 1/2012 Rashid et al. D14/341
D662,932 S * 7/2012 Park et al. D14/341
D674,384 S * 1/2013 Zhang D14/341
D677,255 S * 3/2013 McManigal et al. D14/341
D677,660 S * 3/2013 Groene et al. D14/341
D684,968 S * 6/2013 Smith et al. D14/341
D684,969 S * 6/2013 Smith et al. D14/341
D687,827 S * 8/2013 Song et al. D14/341
D689,048 S * 9/2013 Wang et al. D14/341
D689,482 S * 9/2013 Akana et al. D14/341
D690,297 S * 9/2013 Chang et al. D14/341
D691,996 S * 10/2013 Ohshima D14/341
D692,877 S * 11/2013 Zuege D14/341
D693,340 S * 11/2013 Ohshima D14/341
D696,246 S * 12/2013 Kim D14/341
D701,202 S * 3/2014 Choi D14/341
D702,229 S * 4/2014 Lim et al. D14/341
D702,681 S * 4/2014 Sugiyama et al. D14/341
D703,667 S * 4/2014 Song et al. D14/345
D703,668 S * 4/2014 Kim et al. D14/346

* cited by examiner

Primary Examiner — Barbara Fox

(74) *Attorney, Agent, or Firm* — Rabin & Berdo, P.C.

(57) **CLAIM**

The ornamental design for a tablet computer, as shown and described.

DESCRIPTION

FIG. 1 is a perspective view of a tablet computer showing our new design;
FIG. 2 is a front view thereof;
FIG. 3 is a rear view thereof;
FIG. 4 is a left side view thereof;
FIG. 5 is a right side view thereof;
FIG. 6 is a top view thereof; and,
FIG. 7 is a bottom view thereof.

The broken lines shown in the drawings represent portions of the tablet computer which form no part of the claimed design.

1 Claim, 4 Drawing Sheets

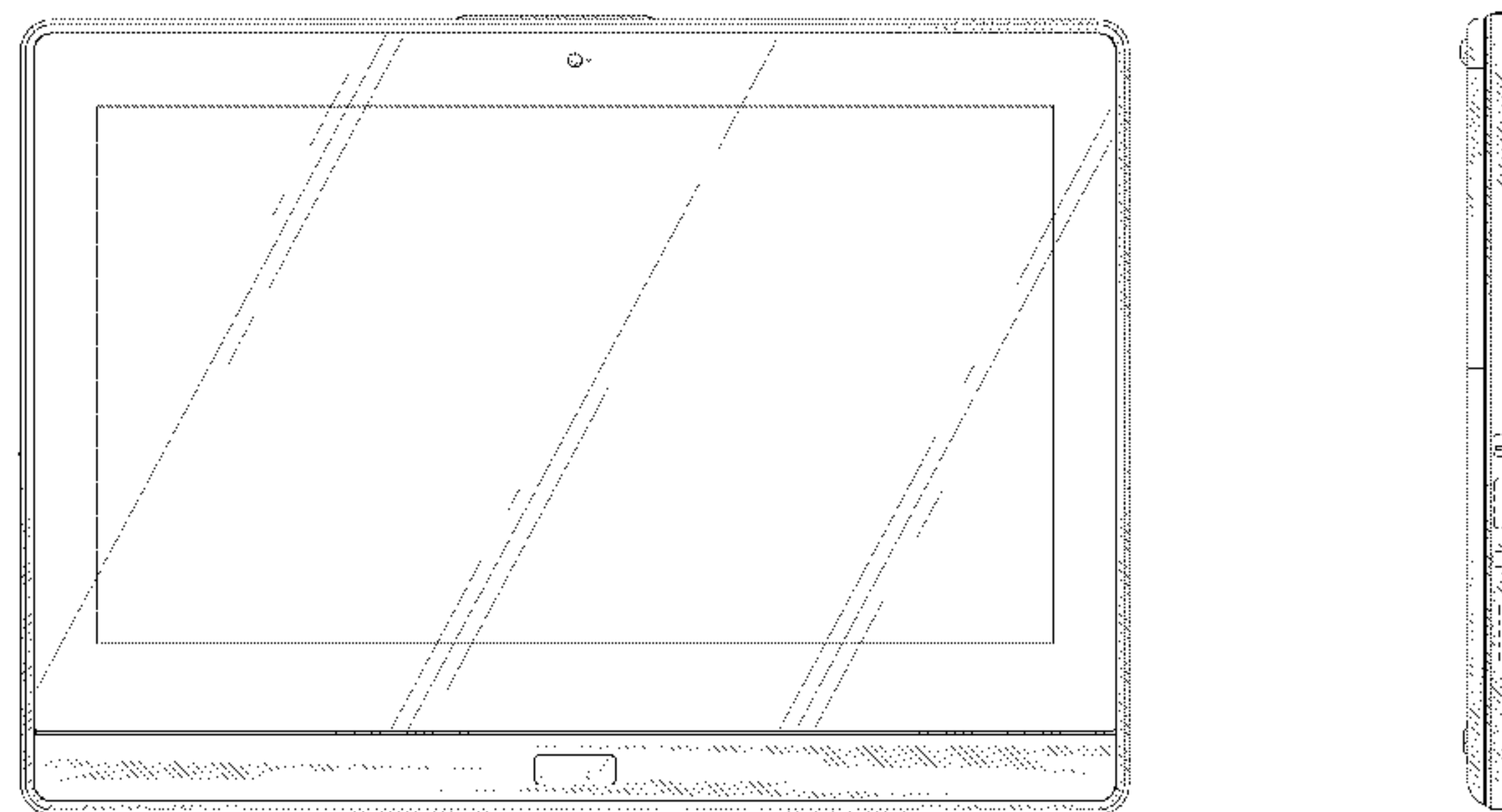

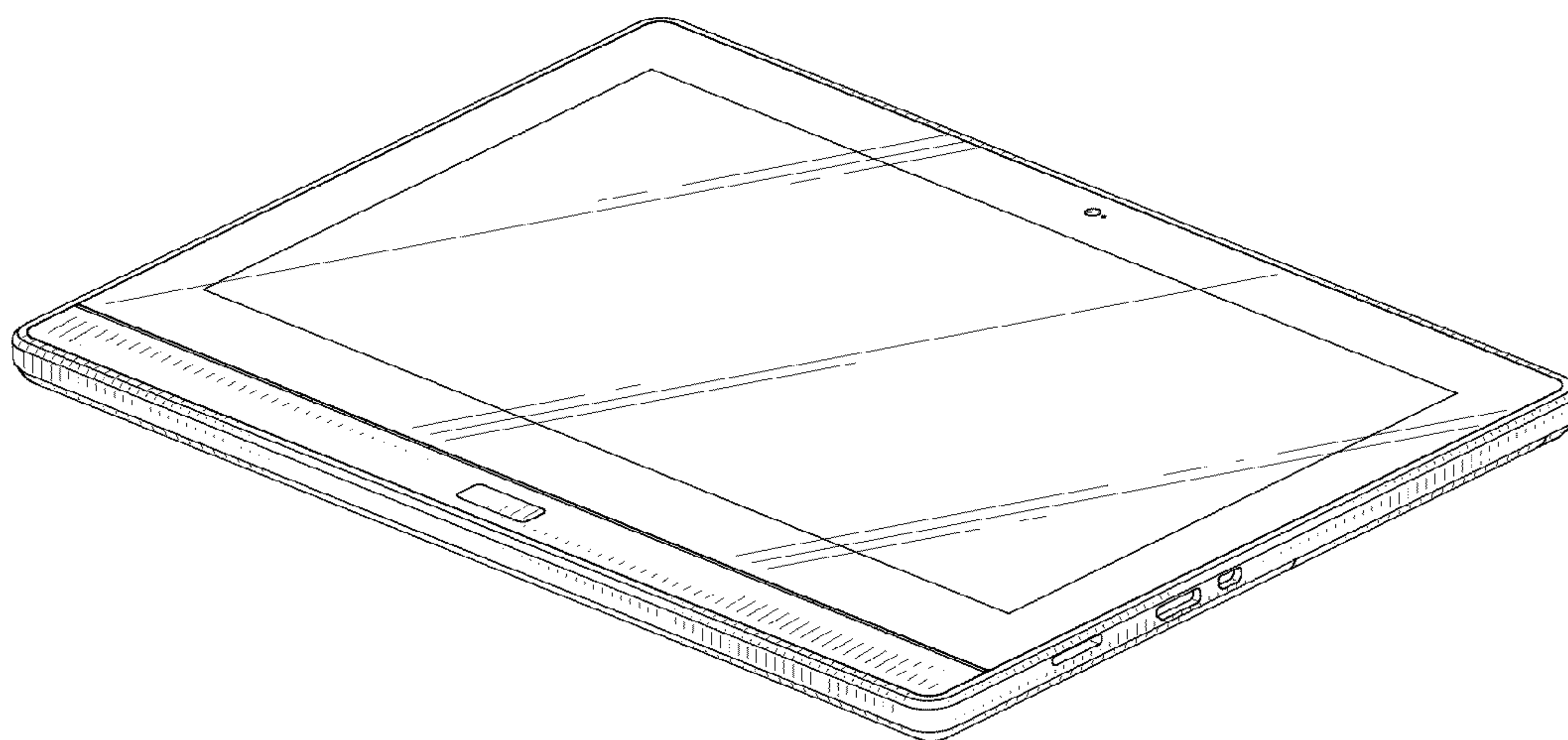

FIG. 1

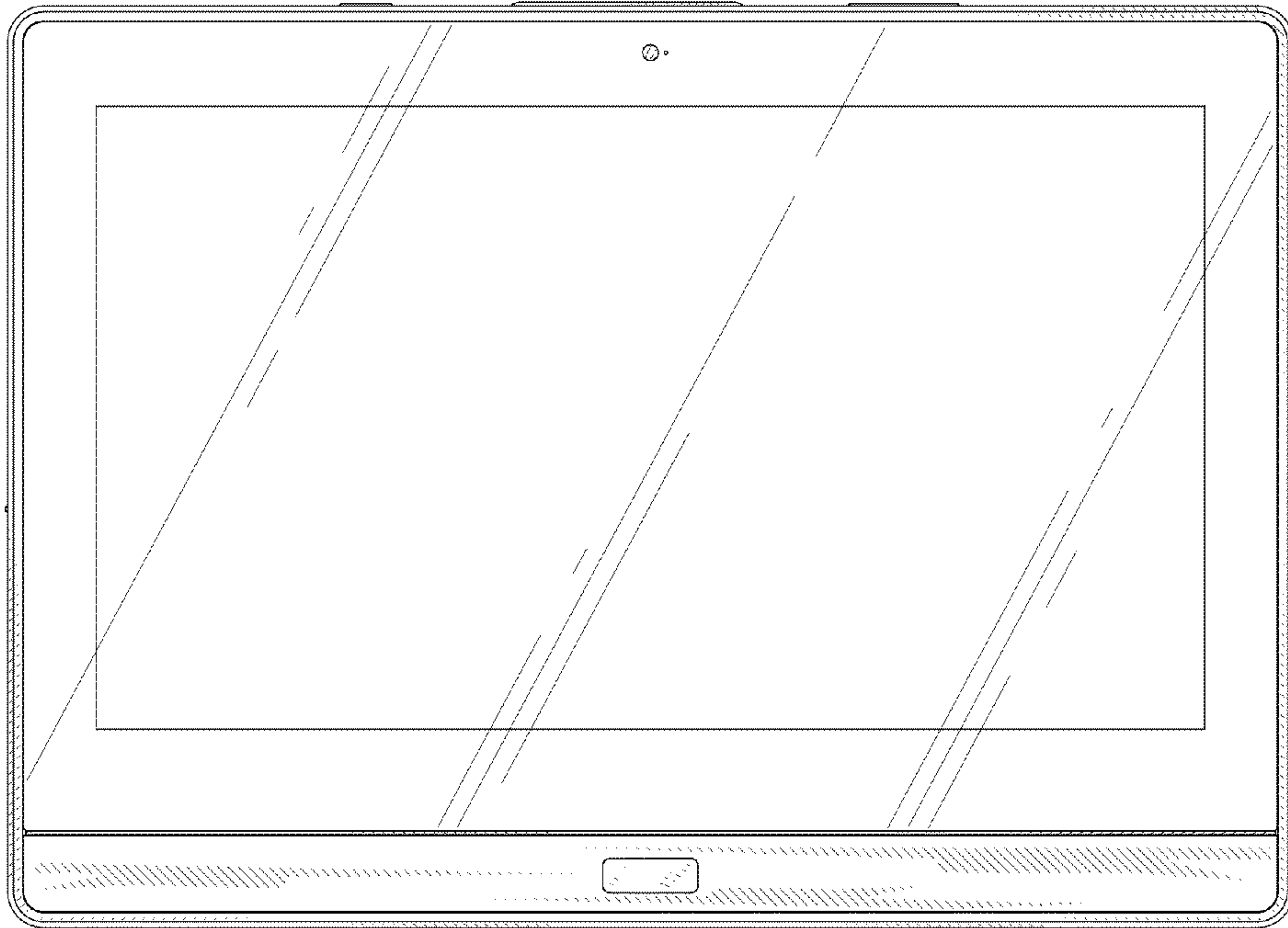

FIG. 2

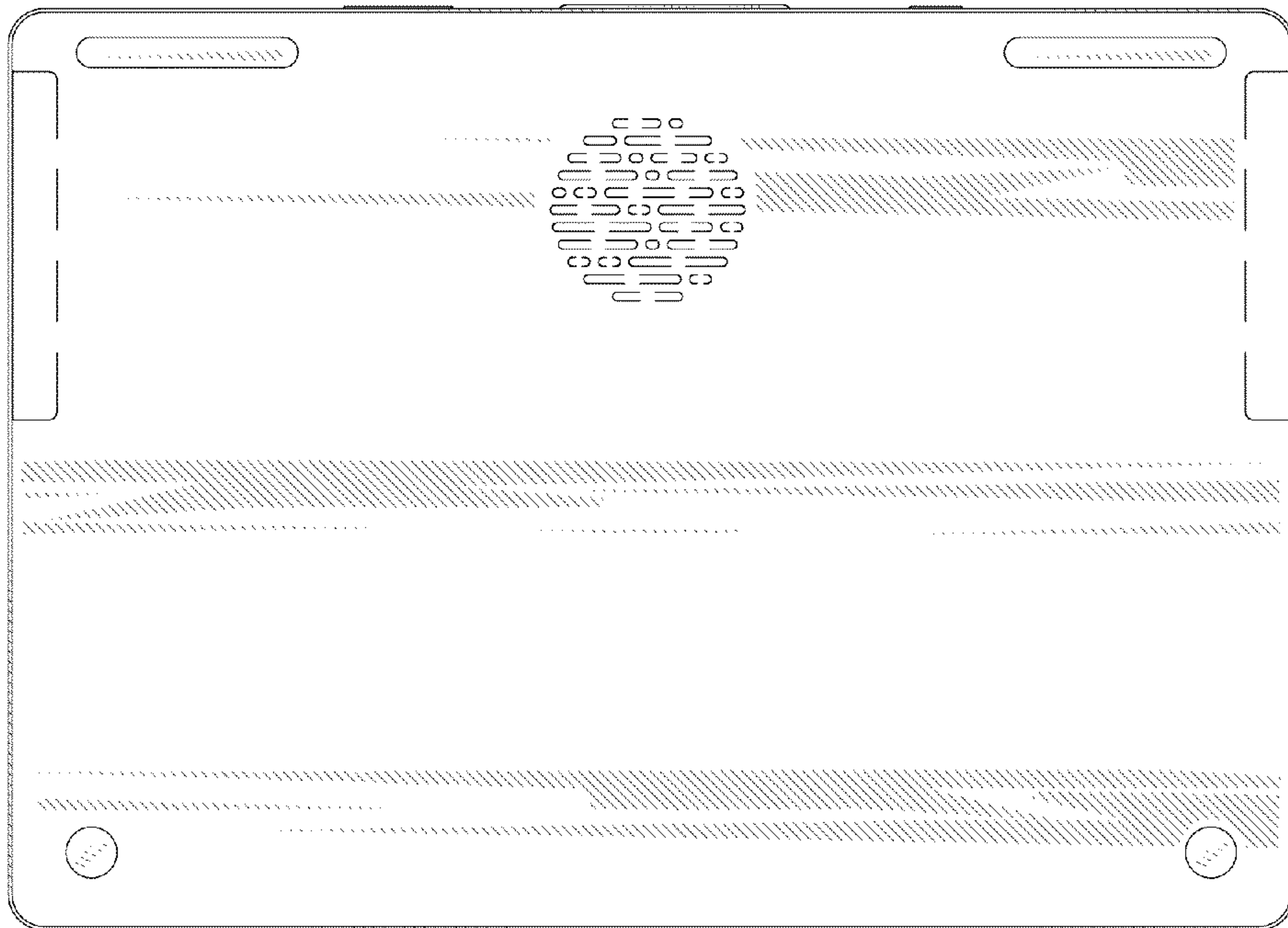

FIG. 3

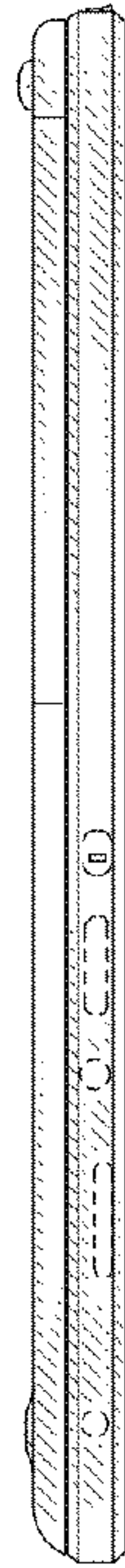

FIG. 4

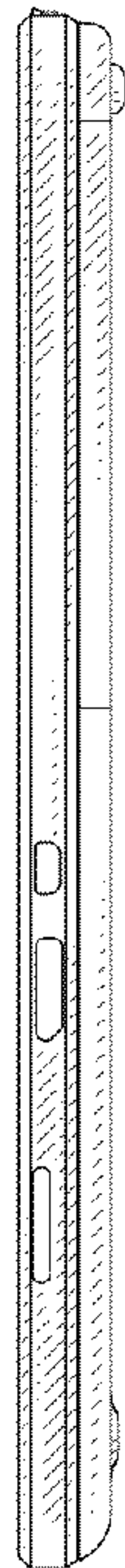

FIG. 5

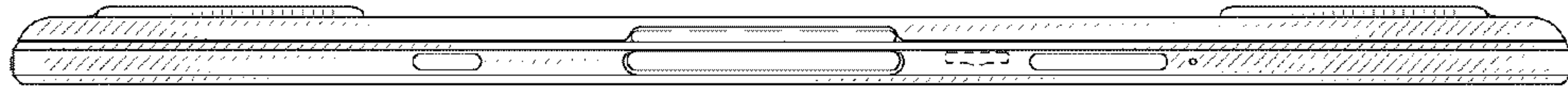

FIG. 6

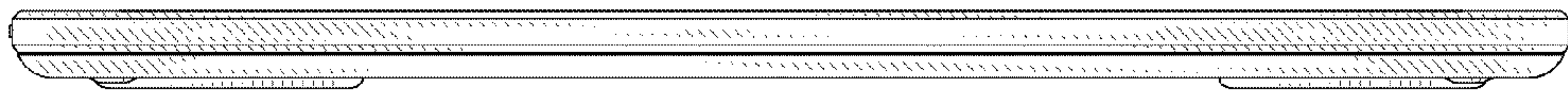

FIG. 7