



US00D711359S

(12) **United States Design Patent**
Marzynski et al.

(10) **Patent No.:** **US D711,359 S**

(45) **Date of Patent:** **** Aug. 19, 2014**

(54) **WIRELESS COMMUNICATION DEVICE**

(71) Applicant: **Fluke Corporation**, Everett, WA (US)

(72) Inventors: **Matthew Marzynski**, Seattle, WA (US);
Paul A. Richer, Everett, WA (US)

(73) Assignee: **Fluke Corporation**, Everett, WA (US)

(**) Term: **14 Years**

(21) Appl. No.: **29/433,409**

(22) Filed: **Sep. 28, 2012**

(51) **LOC (10) Cl.** **14-03**

(52) **U.S. Cl.**
USPC **D14/240**

(58) **Field of Classification Search**
USPC D14/242, 240, 357, 358, 140-140.9,
D14/155, 137, 139, 243, 348, 349, 351, 354,
D14/355; 375/222; 455/557; 725/111
See application file for complete search history.

(56) **References Cited**

U.S. PATENT DOCUMENTS

D408,823 S *	4/1999	Kirby	D14/240
D577,713 S *	9/2008	Kim et al.	D14/218
D585,060 S *	1/2009	Han	D14/358
D609,221 S *	2/2010	Kim et al.	D14/218
D644,221 S *	8/2011	Kemery et al.	D14/358
D650,377 S *	12/2011	Akana et al.	D14/314

D651,993 S *	1/2012	Cheng	D14/125
D656,126 S *	3/2012	Choi et al.	D14/218
D660,839 S *	5/2012	Govindasamy et al.	D14/358
D686,198 S *	7/2013	Lewis et al.	D14/240
D686,201 S *	7/2013	Lee	D14/314
D692,884 S *	11/2013	Kim et al.	D14/368
D694,233 S *	11/2013	Hoofnagle et al.	D14/356

* cited by examiner

Primary Examiner — Bridget L Eland

(74) *Attorney, Agent, or Firm* — Christensen O'Connor Johnson Kindness PLLC

(57) **CLAIM**

The ornamental design for a wireless communication device, as shown and described.

DESCRIPTION

FIG. 1 is a top front right perspective view of the wireless communication device showing our new design; FIG. 2 is a front elevation view of the design of FIG. 1; FIG. 3 is a rear elevation view of the design of FIG. 1; FIG. 4 is a top plan view of the design of FIG. 1; FIG. 5 is a bottom plan view of the design of FIG. 1; FIG. 6 is a left side elevation view of the design of FIG. 1; FIG. 7 is a right side elevation view of the design of FIG. 1; and, FIG. 8 is a bottom rear left perspective view of the design of FIG. 1.

The broken lines shown in the views are included for the purpose of illustrating portions of the wireless communication device that form no part of the claimed design.

1 Claim, 6 Drawing Sheets

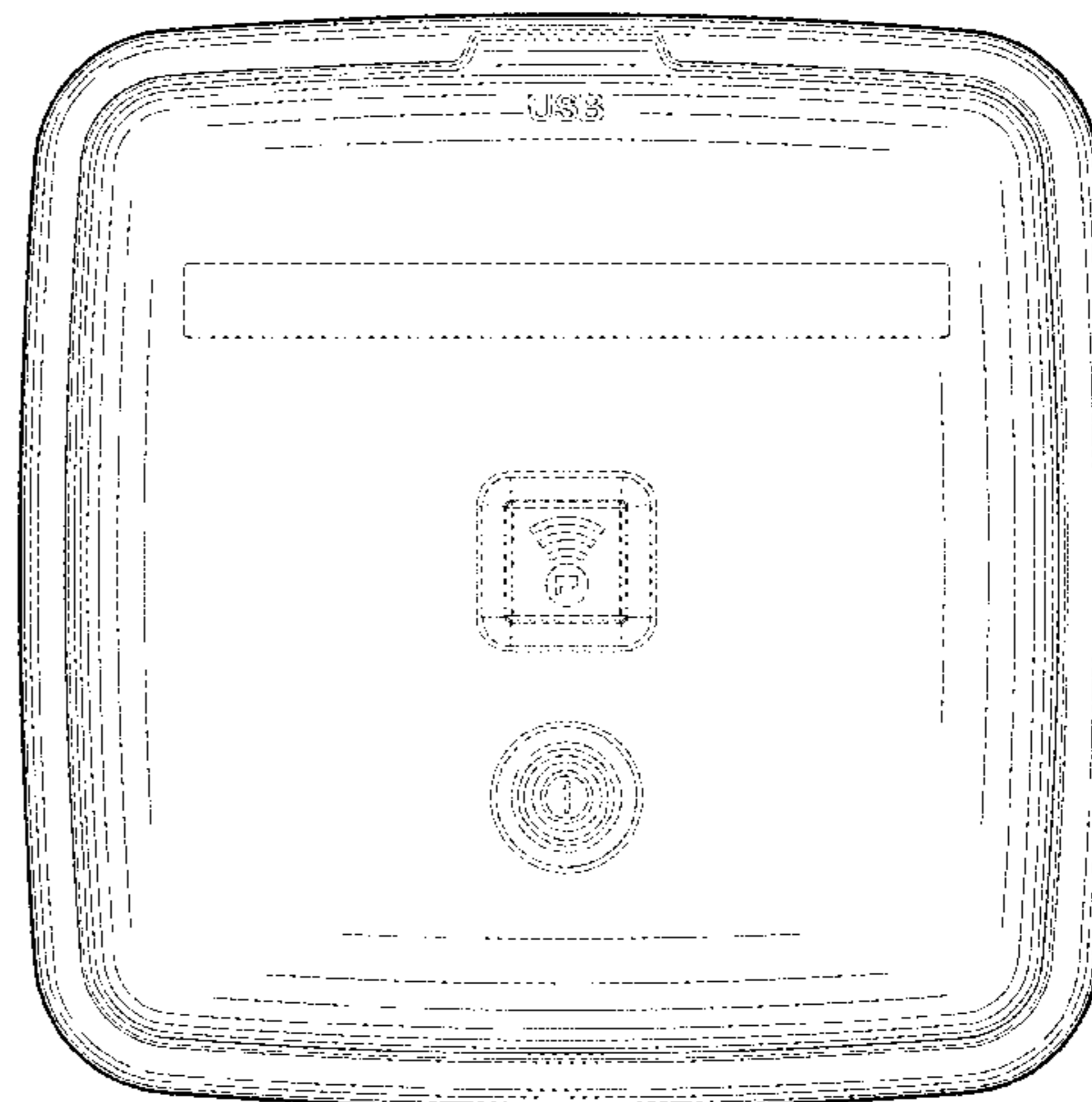
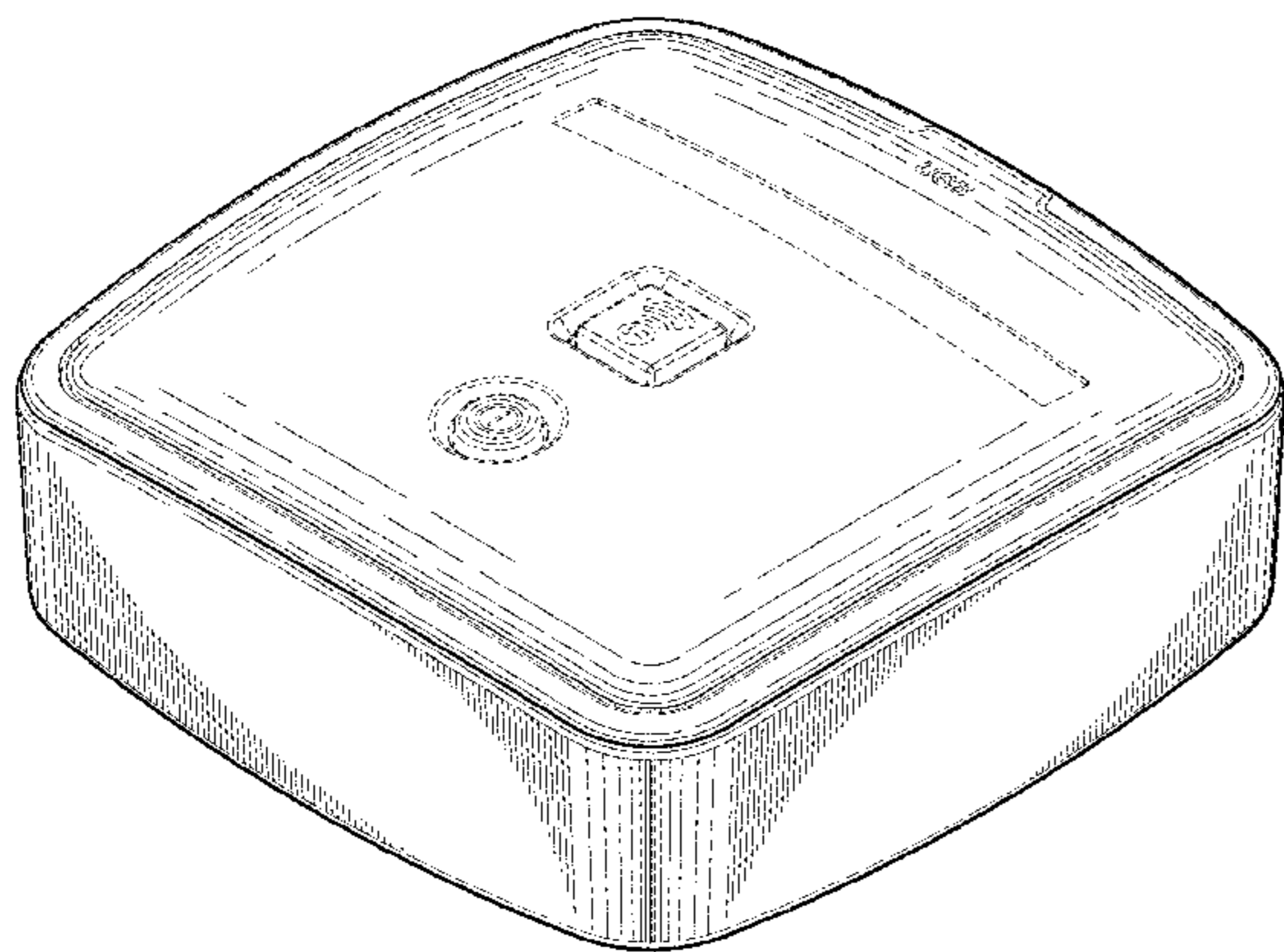

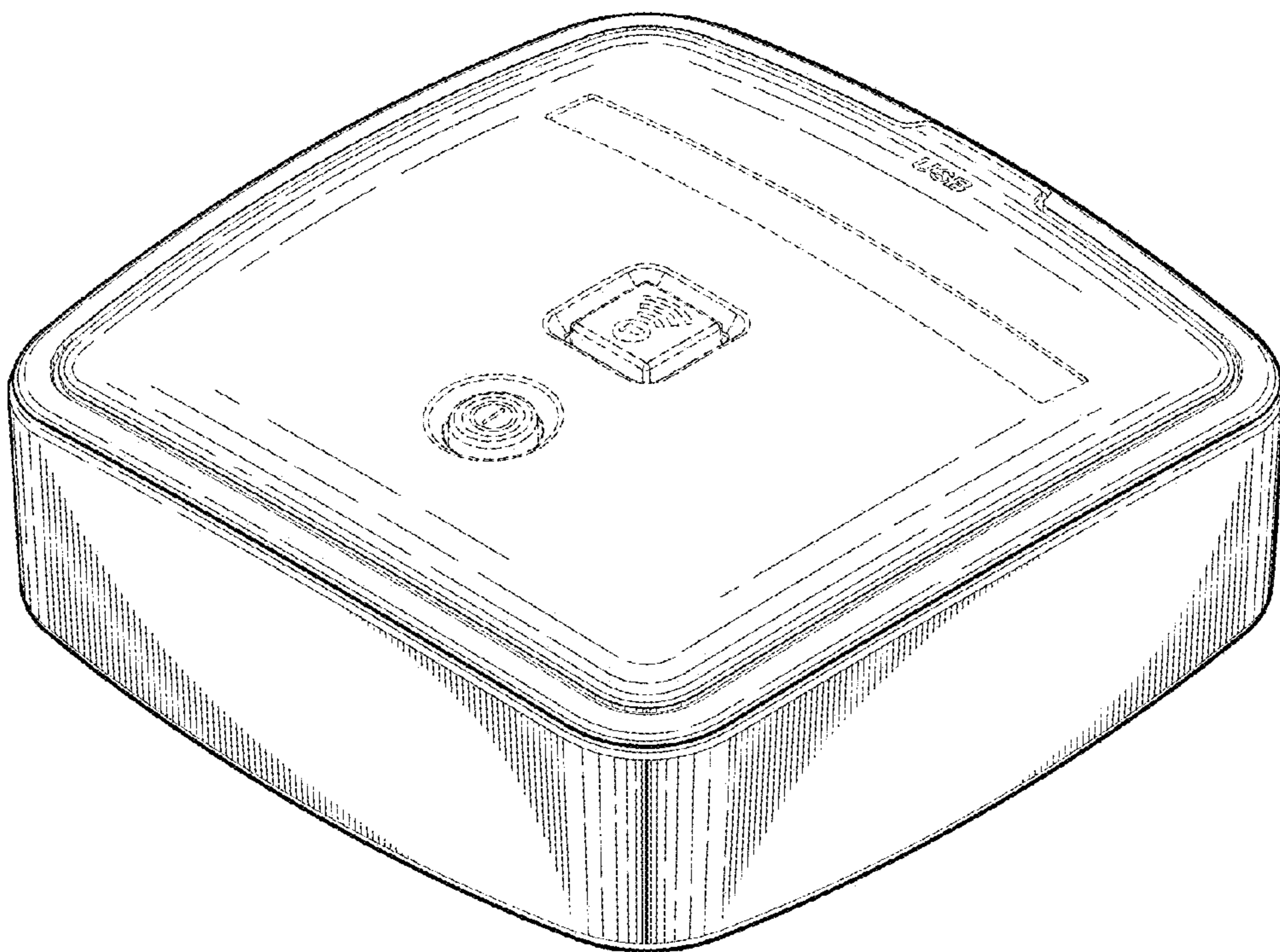

Fig. 1.

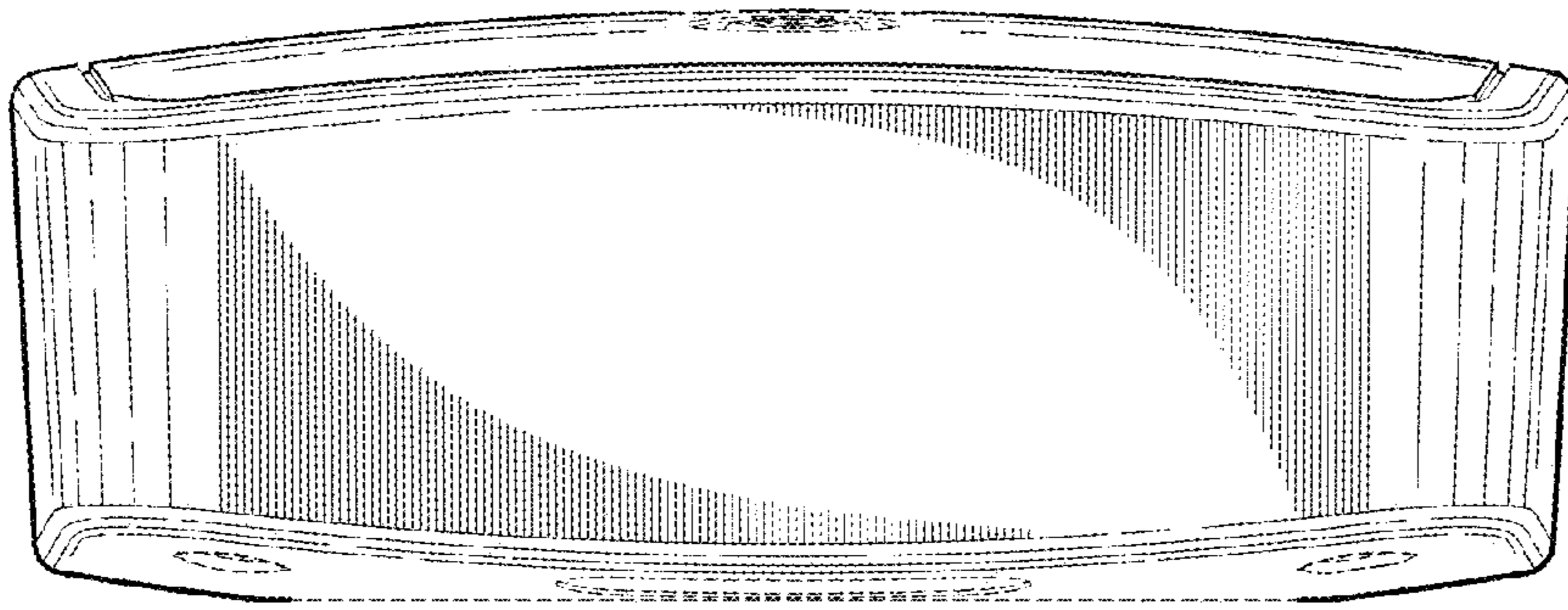

Fig. 2.

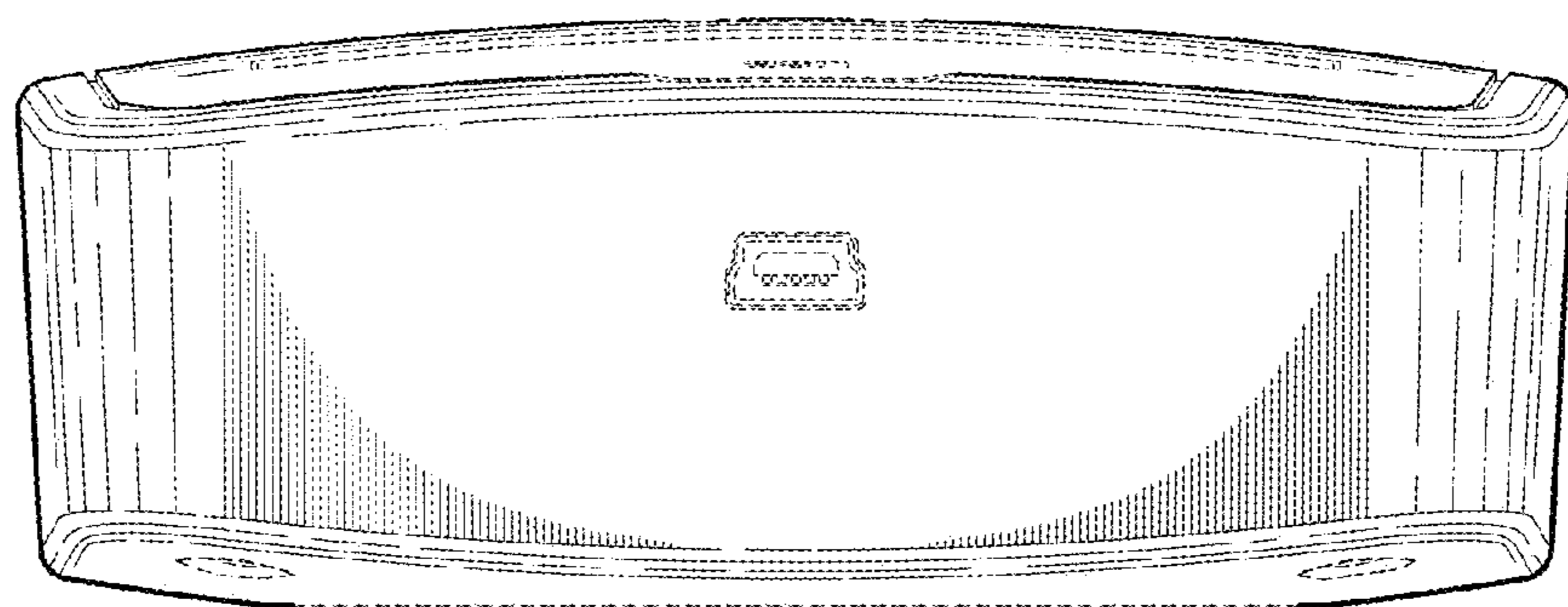

Fig. 3.

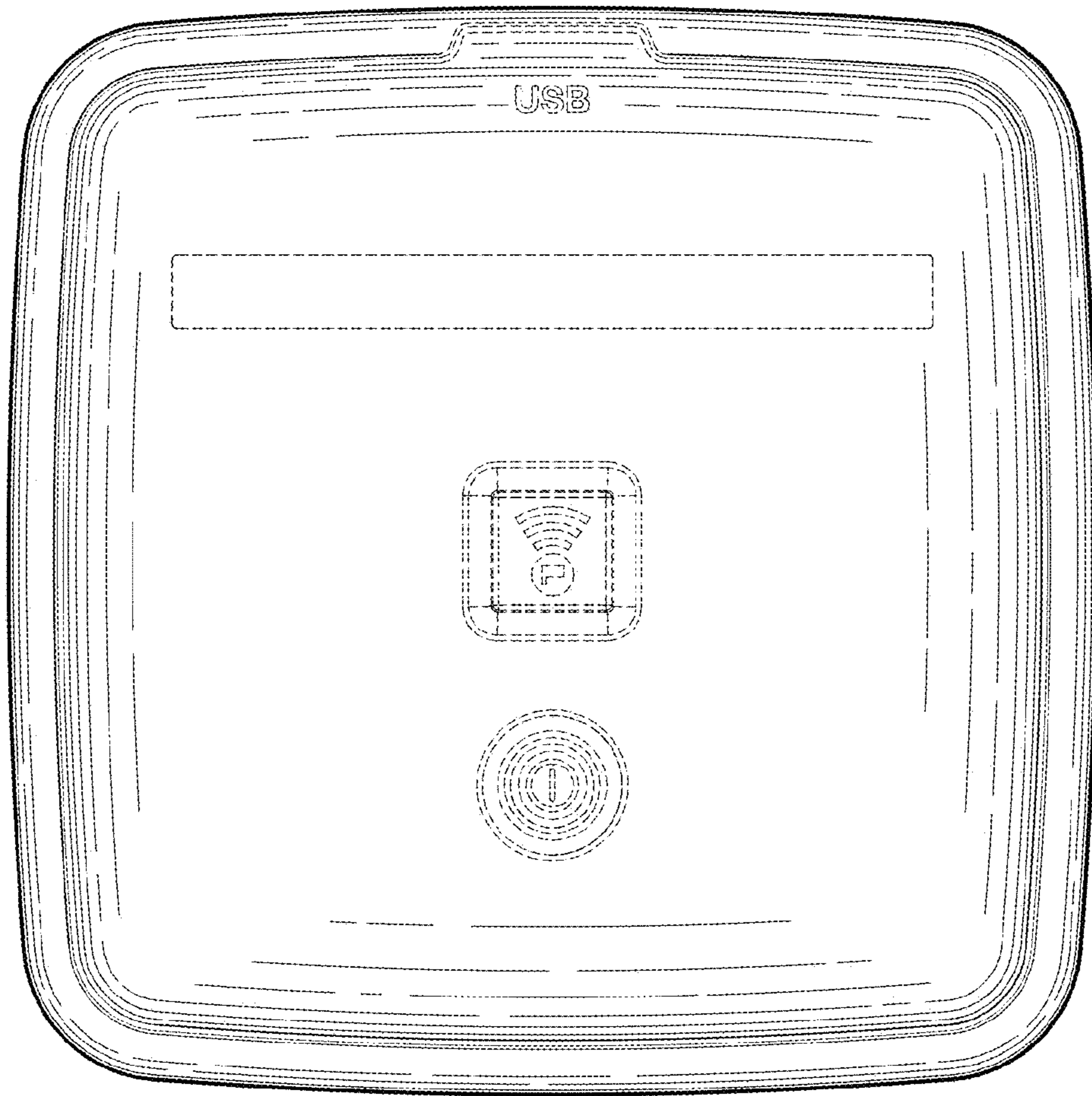

Fig. 4.

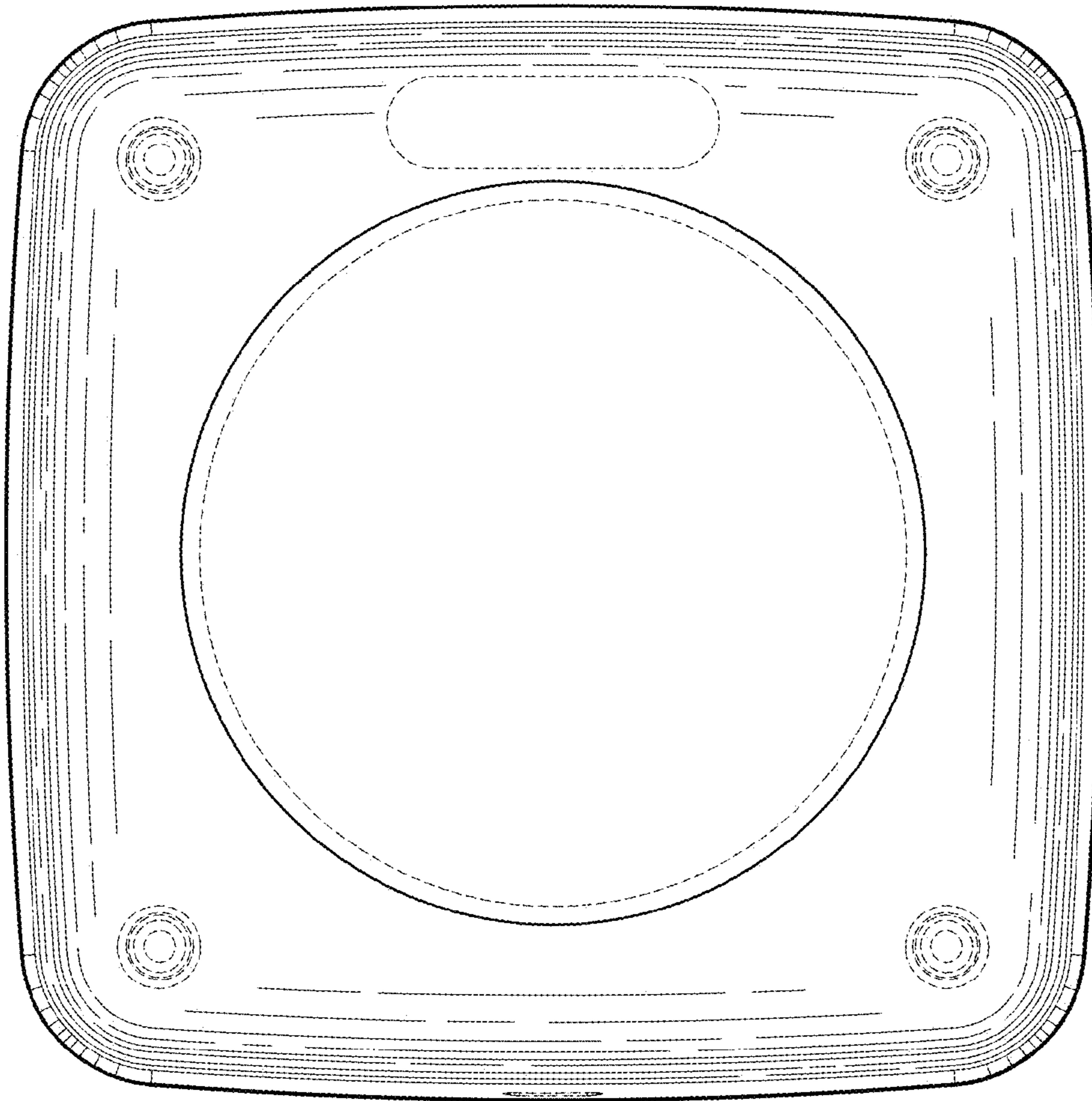

Fig. 5.

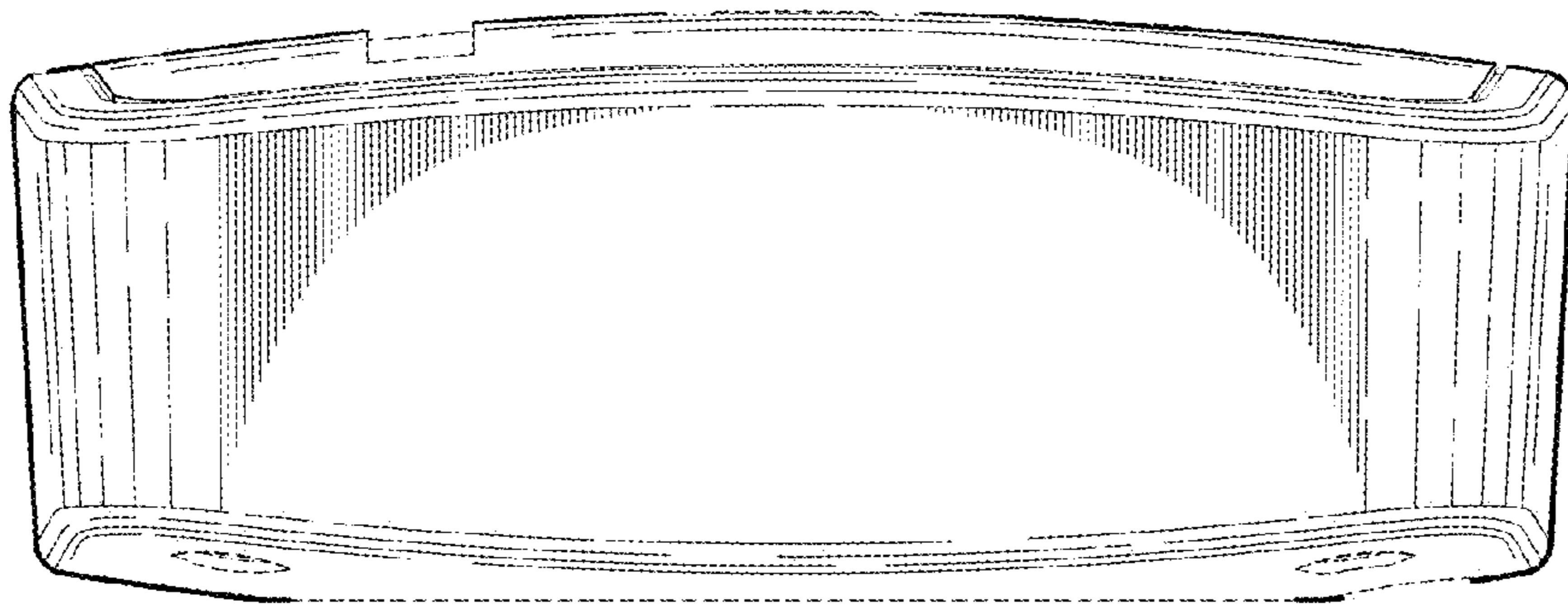

Fig. 6.

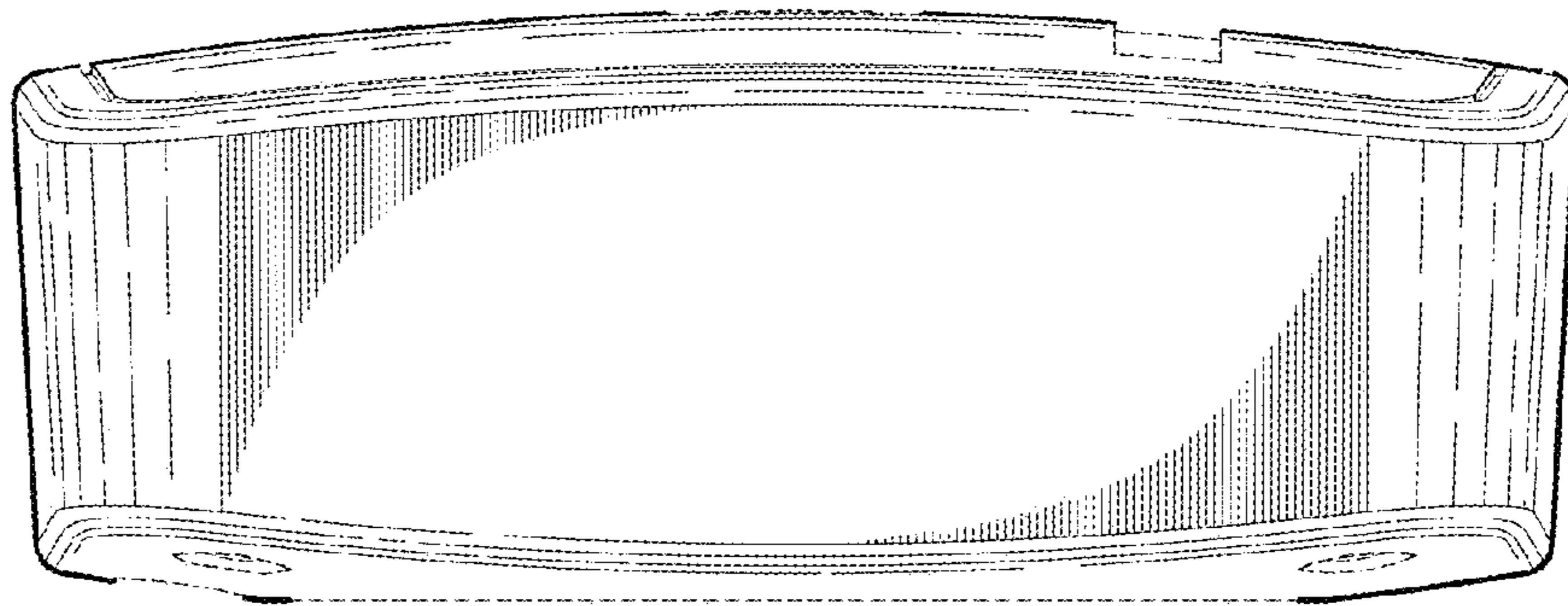

Fig. 7.

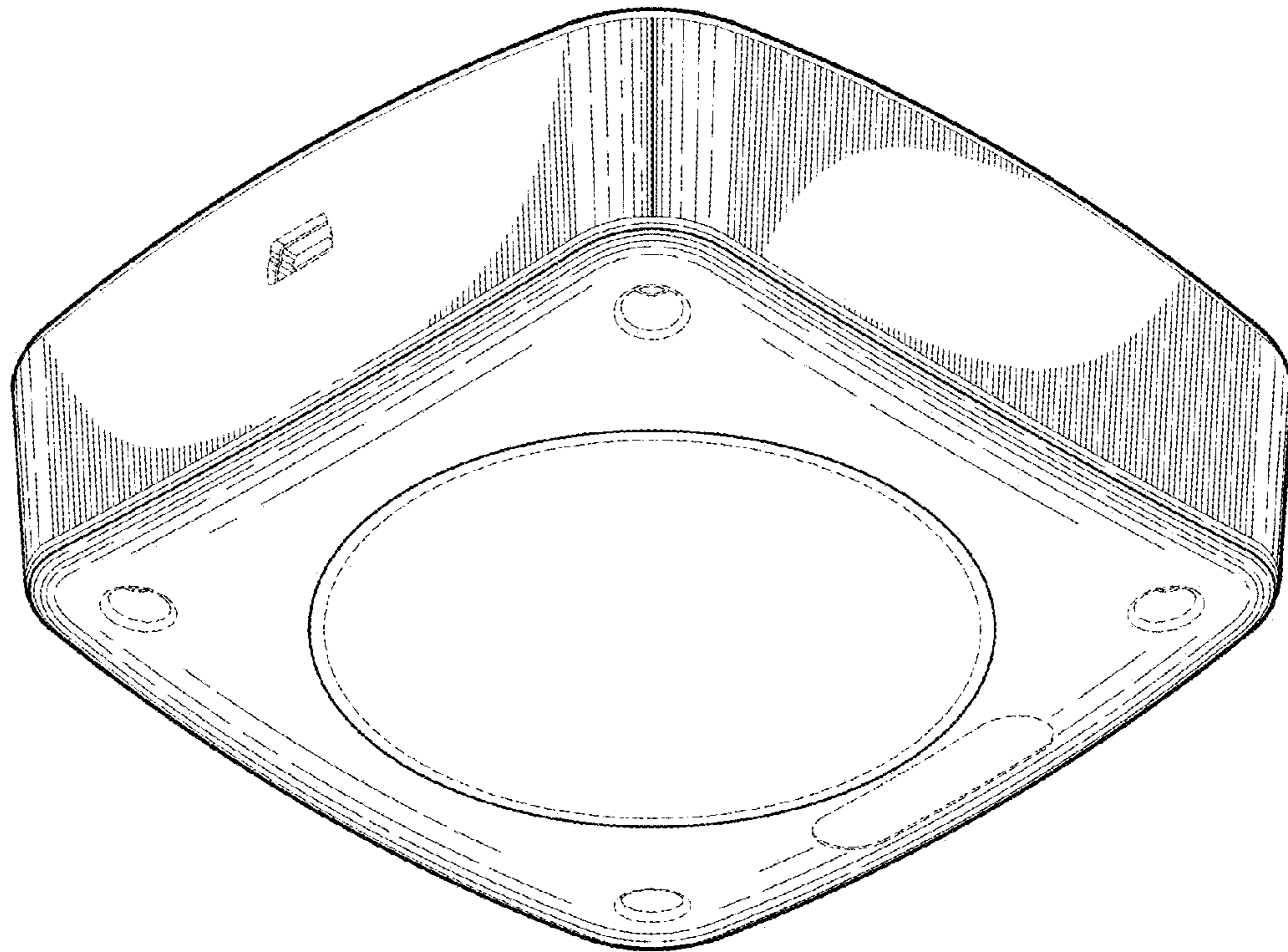

Fig. 8.