



US00D711306S

(12) **United States Design Patent**
Jackson et al.

(10) **Patent No.:** **US D711,306 S**
(45) **Date of Patent:** **** Aug. 19, 2014**

(54) **AUTOMOBILE ADORNMENT**

(75) Inventors: **Andrew Jackson**, Tierra Verde, FL (US);
Chris Hillman, Santa Cruz, CA (US)

(73) Assignee: **ADJ Inc.**, Tierra Verde, FL (US)

(**) Term: **14 Years**

(21) Appl. No.: **29/429,354**

(22) Filed: **Aug. 9, 2012**

(51) **LOC (10) Cl.** **12-16**

(52) **U.S. Cl.**
USPC **D12/400**

(58) **Field of Classification Search**

USPC D12/400, 82-83, 197, 199, 421, 196,
D12/210, 223, 190; 40/218;
D29/101.1-101.5

See application file for complete search history.

(56) **References Cited**

U.S. PATENT DOCUMENTS

5,928,056	A *	7/1999	Molotschko	446/418
D468,463	S	1/2003	Macklin et al.		
D521,924	S *	5/2006	Valeri	D12/400
D522,956	S *	6/2006	Valeri	D12/400
D534,476	S	1/2007	Valeri		
D534,477	S *	1/2007	Valeri	D12/400
D534,478	S *	1/2007	Valeri	D12/400
D591,666	S *	5/2009	Valeri	D12/400
D591,668	S *	5/2009	Valeri	D12/400
D591,669	S *	5/2009	Valeri	D12/400
D591,795	S *	5/2009	Heise	D20/30
D599,273	S *	9/2009	Valeri	D12/400
2006/0026850	A1 *	2/2006	Goslee et al.	33/357
2012/0291716	A1 *	11/2012	Cook et al.	119/600

OTHER PUBLICATIONS

Christmas Reindeer Car Decorating Kit, Windy City Novelties, Inc.,
<http://www.windycitynovelties.com/195630p/reindeer-car-decorating-kit.html?s>, retrieved May 24, 2012, three pages.

Vintage Reindeer Christmas Ornament from Zazzle.com, Zazzle,
http://www.zazzle.com/vintage_reindeer_christmas_ornament-175300047622172352, retrieved May 24, 2012, six pages.

Vintage Deer and Antler Christmas Ornament Picks Glittered Bronze, primitivepincushion.com, <http://www.etsy.com/listing/98782527/vintage-deer-and-antler-christmas>, retrieved May 24, 2012, two pages.

3 Vintage Plastic Reindeer W/Antlers Ornaments, ePIER, <http://www.epier.com/BiddingForm.asp?1950472>, retrieved May 24, 2012, three pages.

Reindeer Car Kit, Party City, <http://www.partycity.com/product/reindeer+car+kit.do>, retrieved May 24, 2012, two pages.

Antique & Vintage Christmas, Dresden Star Ornaments, <http://www.easycart.net/DresdenStarOrnaments/Christmas.html>, retrieved May 24, 2012, eight pages.

(Continued)

Primary Examiner — Katrina A Betton

(74) *Attorney, Agent, or Firm* — Foley & Lardner LLP

(57) **CLAIM**

The ornamental design for automobile adornment, as shown and described.

DESCRIPTION

FIG. 1 is a front elevational view of automobile adornment showing our new design;

FIG. 2 is a rear elevational view thereof;

FIG. 3 is a perspective view thereof;

FIG. 4 is a side elevational view, the opposite side being a mirror image thereof;

FIG. 5 is a top view thereof;

FIG. 6 is a bottom view thereof; and,

FIG. 7 is a front elevational view of our new automobile adornment design applied to an automobile.

The automobile is shown in broken lines for illustrative purposes only and forms no part of the claimed design.

1 Claim, 3 Drawing Sheets

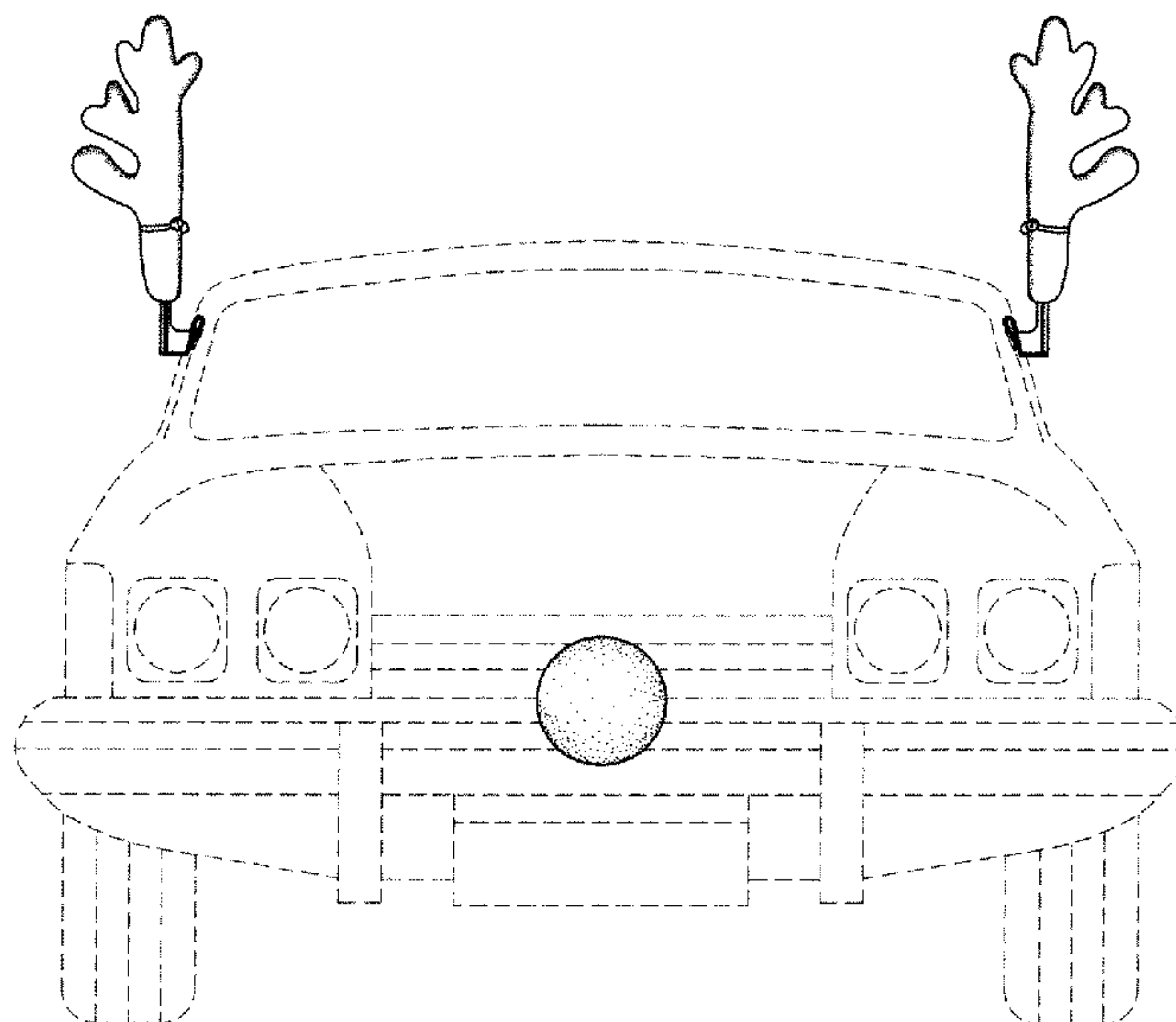

(56)

References Cited

OTHER PUBLICATIONS

Christmas Hat/Reindeer Antlers: Reindeer Antlers with Ears, Rusty Zipper, <http://www.rustyzipper.com/shop.cfm?viewpartnum=200147>, retrieved Dec. 13, 2012, three pages.

1990's Jingle Bell Antler Headband Style Hat: 90's Style-Christmas Antler, Rusty Zipper, <http://www.rustyzipper.com/shop.cfm?viewpartnum=198628&slidesize=&>, retrieved Dec. 13, 2012, three pages.

Hinsaw, Dorothy (photographs by Munoz, William), White-Tailed Deer, Early Bird Nature Book, Lerner Publications Company, 2005, four pages.

* cited by examiner

Fig. 1

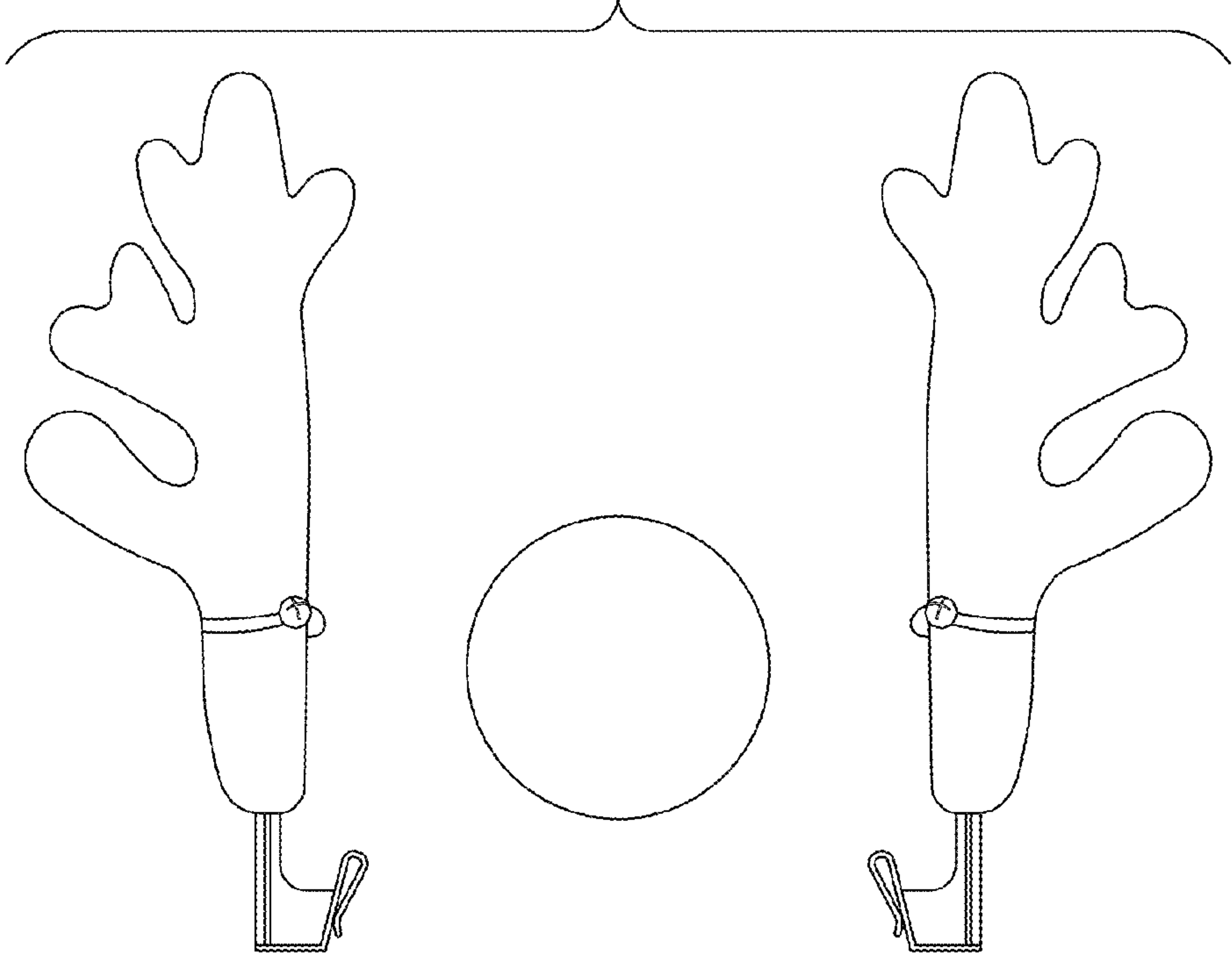

Fig. 2

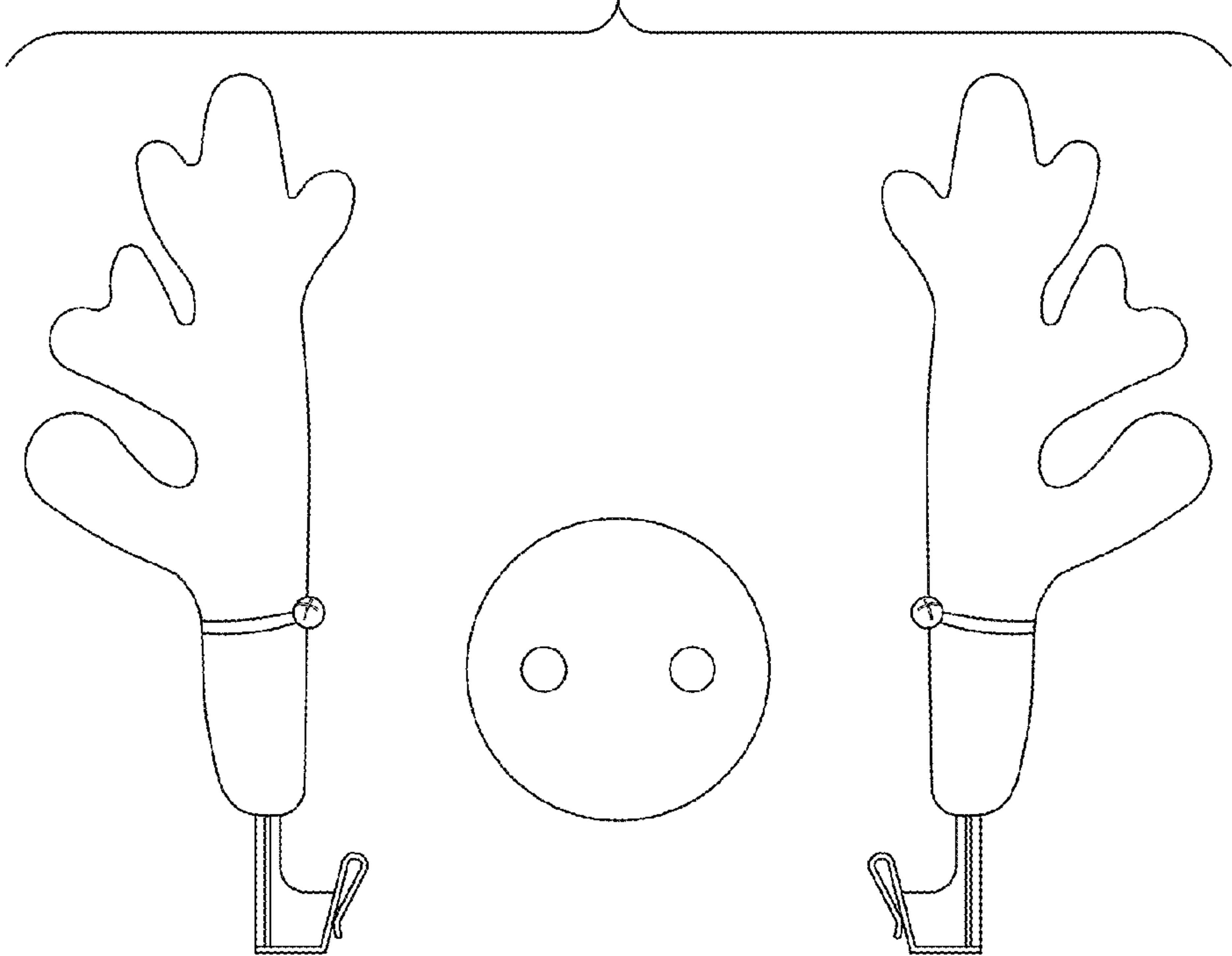

Fig. 3

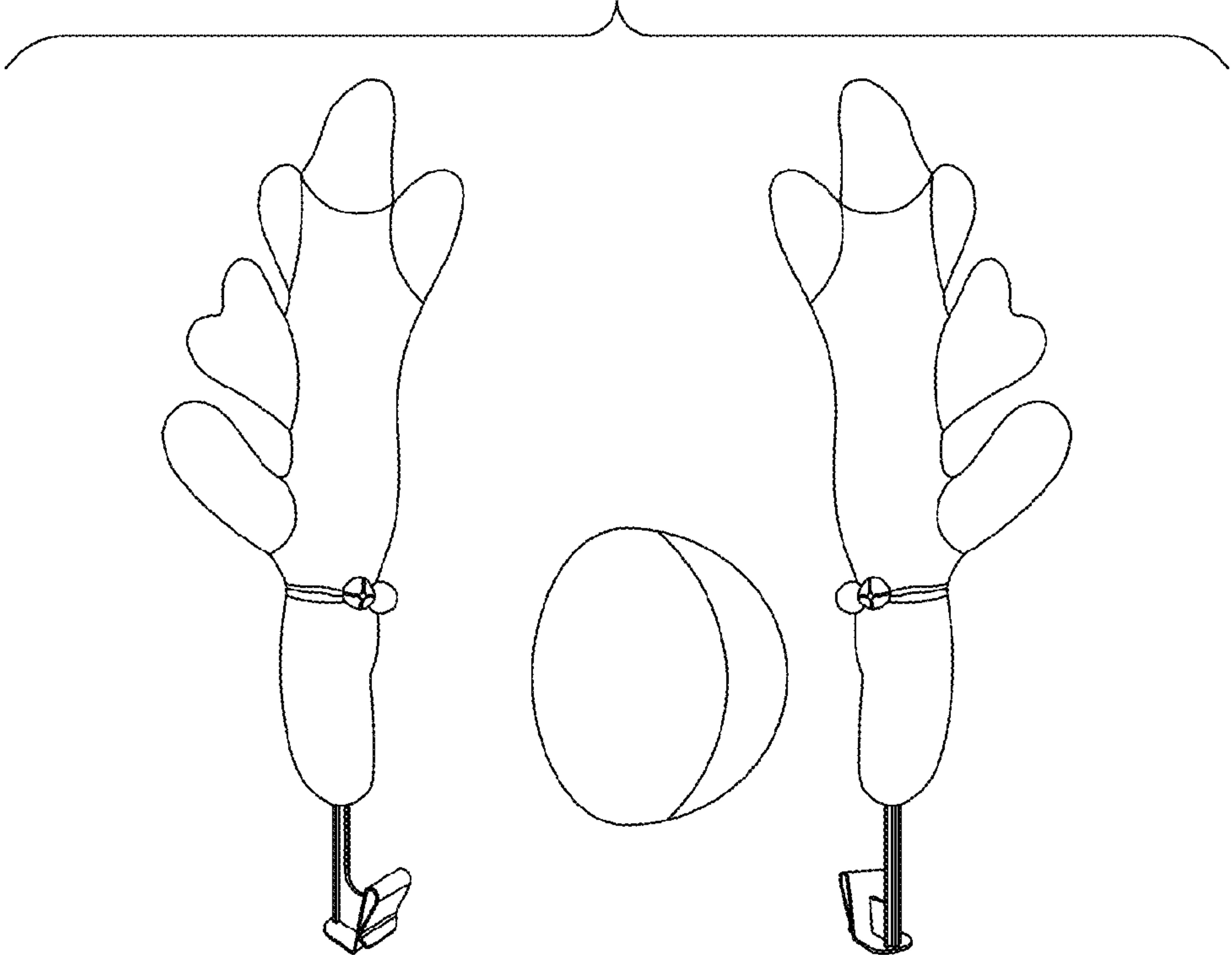

Fig. 4

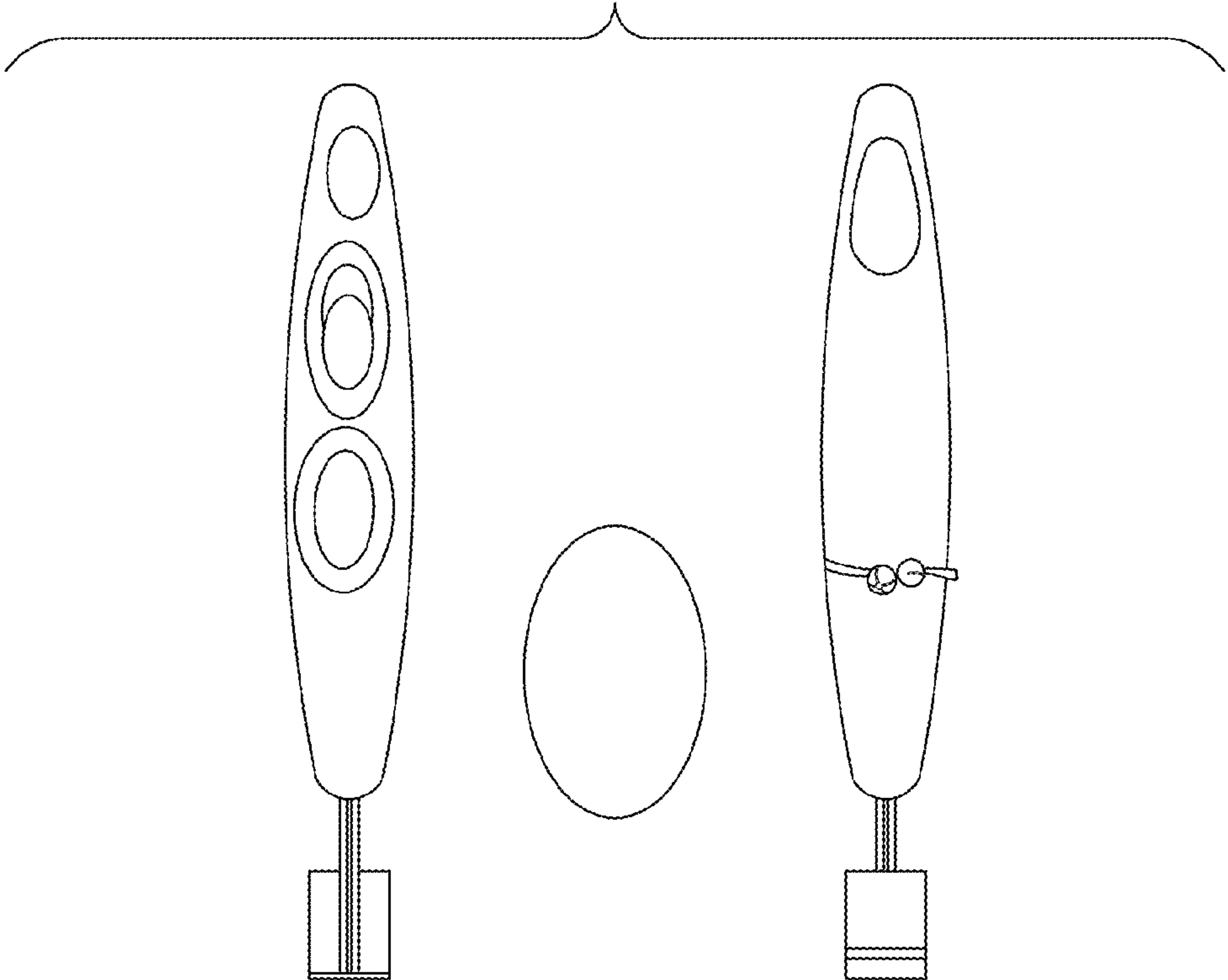

Fig. 5

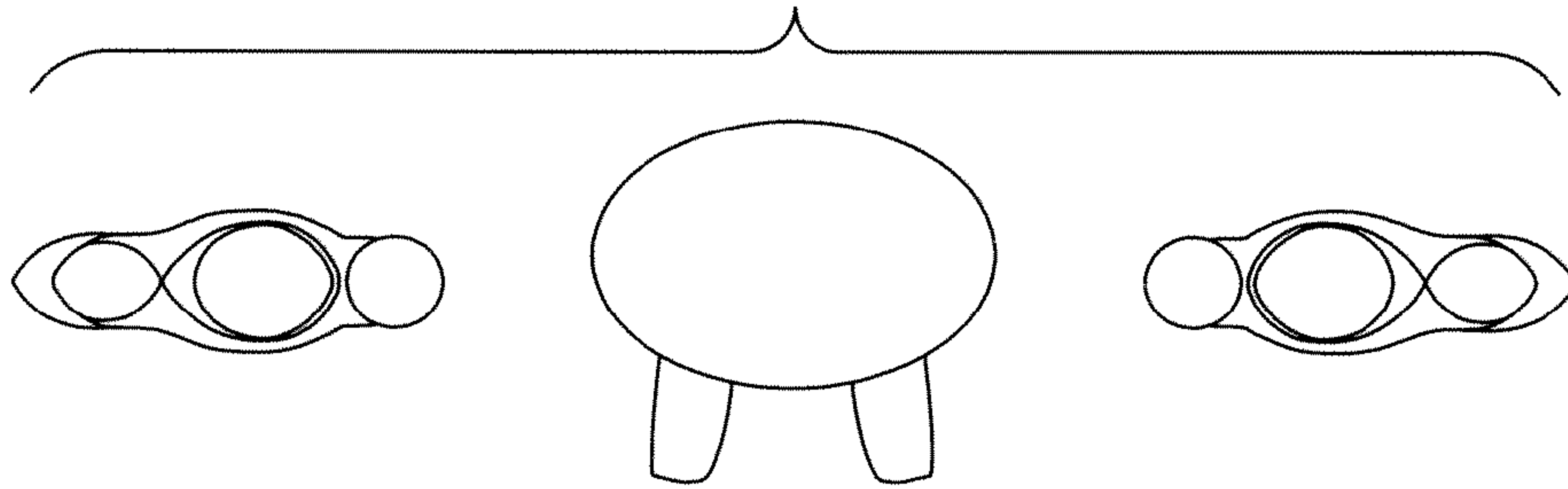

Fig. 6

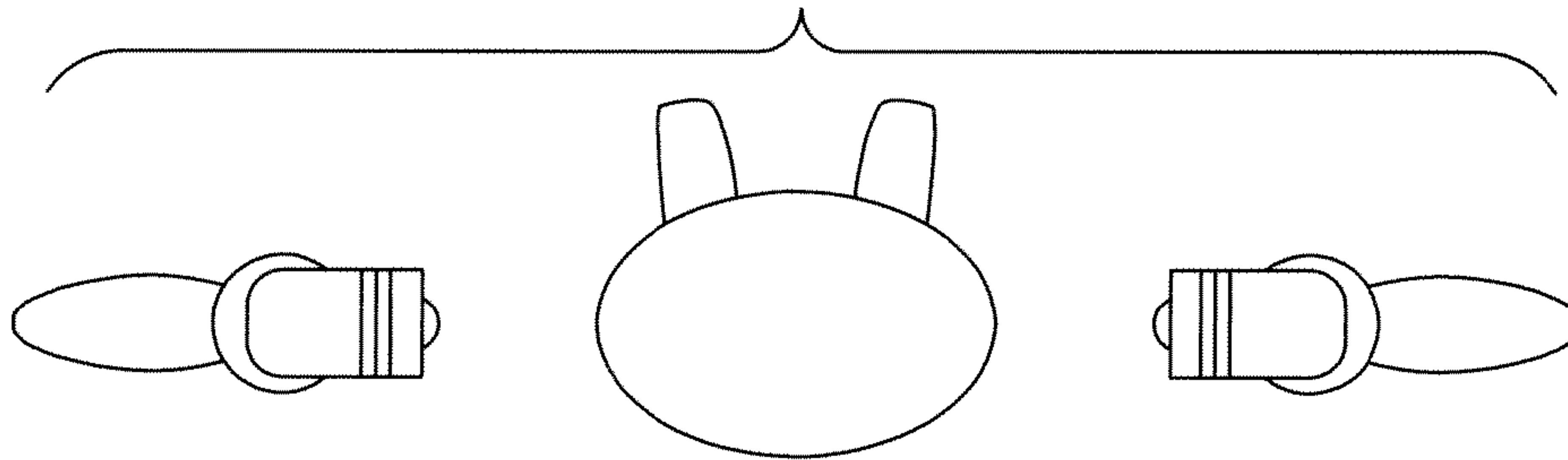

Fig. 7

