



US00D711217S

(12) **United States Design Patent**  
**Jacobs et al.**

(10) **Patent No.:** **US D711,217 S**

(45) **Date of Patent:** **\*\* Aug. 19, 2014**

(54) **PACKAGE FOR RETAIL DISPLAY AND SALE**

(71) Applicant: **Velcro Industries B.V.**, Curacao (NL)

(72) Inventors: **Jurjen Jacobs**, Barcelona (ES); **Sophie Louise Walker**, Knutsford (GB); **Trudie Johnson**, Staffordshire (GB)

(73) Assignee: **Velcro Industries B.V.**, Willemstad, Curacao

(\*\*) Term: **14 Years**

(21) Appl. No.: **29/435,425**

(22) Filed: **Oct. 24, 2012**

(51) **LOC (10) Cl.** ..... **09-03**

(52) **U.S. Cl.**  
USPC ..... **D9/414**

(58) **Field of Classification Search**

USPC ..... D9/414, 415, 416, 417, 418, 419, 420,  
D9/424, 430, 431-433, 457, 346, 732, 703,  
D9/423; D6/682.4; D11/207; 40/124.01,  
40/124.16, 124.191; 206/39, 337, 538,  
206/704, 461, 462, 463, 471; 229/72, 75,  
229/113, 116

See application file for complete search history.

(56) **References Cited**

**U.S. PATENT DOCUMENTS**

2,802,565 A \* 8/1957 Kabbash ..... 229/125.015  
3,078,989 A \* 2/1963 Curran et al. .... 206/440  
D303,500 S \* 9/1989 Colla ..... D9/414  
D422,210 S \* 4/2000 Sturkie et al. .... D9/707  
D447,689 S \* 9/2001 Navet et al. .... D9/430  
D454,305 S \* 3/2002 Bryan et al. .... D9/433

D454,495 S \* 3/2002 Bryan et al. .... D9/433  
D519,832 S \* 5/2006 Demathieu et al. .... D9/430  
D568,763 S \* 5/2008 Keberlein ..... D9/734

**OTHER PUBLICATIONS**

Osram Bulb Packaging; published before Oct. 24, 2011; 1 page.

\* cited by examiner

*Primary Examiner* — Ian Simmons

*Assistant Examiner* — Rhea Shields

(74) *Attorney, Agent, or Firm* — Fish & Richardson P.C.

(57) **CLAIM**

The ornamental design for a package for retail display and sale, substantially as shown and described.

**DESCRIPTION**

FIG. 1 is a front perspective view of a first embodiment of our package.

FIG. 2 is a front view of the embodiment of FIG. 1.

FIG. 3 is a back view of the embodiment of FIG. 1.

FIG. 4 is a left side view of the embodiment of FIG. 1.

FIG. 5 is a right side view of the embodiment of FIG. 1.

FIG. 6 is a top view of the embodiment of FIG. 1.

FIG. 7 is a bottom view of the embodiment of FIG. 1.

FIG. 8 is a front perspective view of a second embodiment of our package.

FIG. 9 is a front view of the embodiment of FIG. 8.

FIG. 10 is a back view of the embodiment of FIG. 8.

FIG. 11 is a left side view of the embodiment of FIG. 8.

FIG. 12 is a right side view of the embodiment of FIG. 8.

FIG. 13 is a top view of the embodiment of FIG. 8; and,

FIG. 14 is a bottom view of the embodiment of FIG. 8.

The broken lines illustrate environmental features that form no part of the claimed design.

**1 Claim, 5 Drawing Sheets**

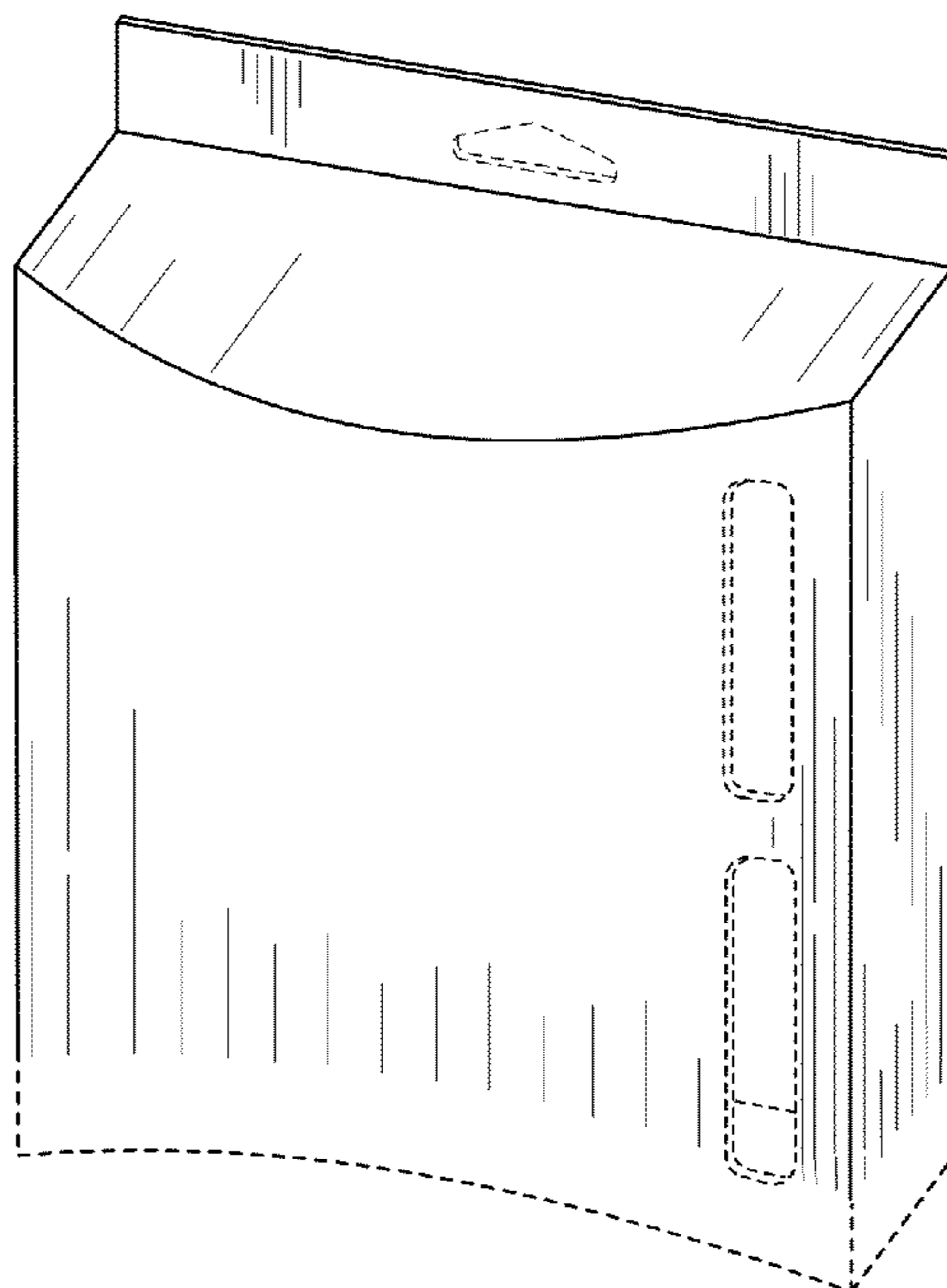
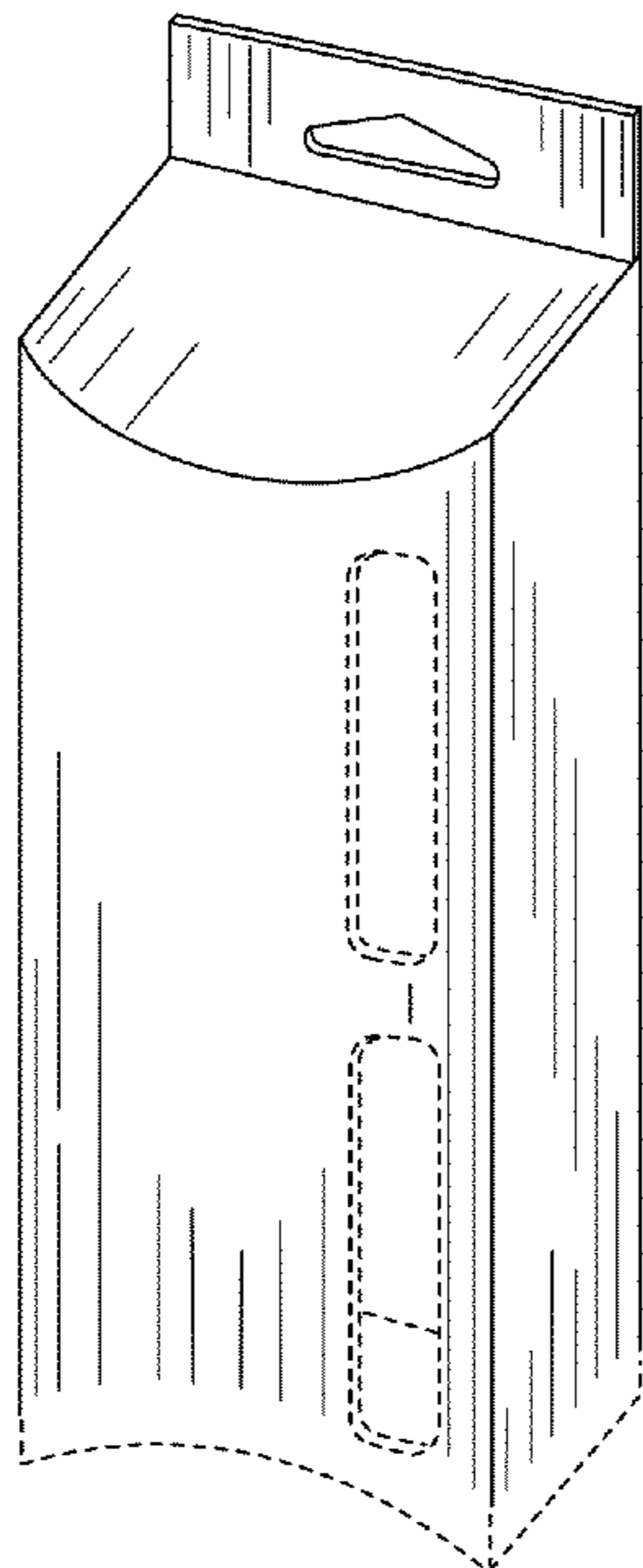

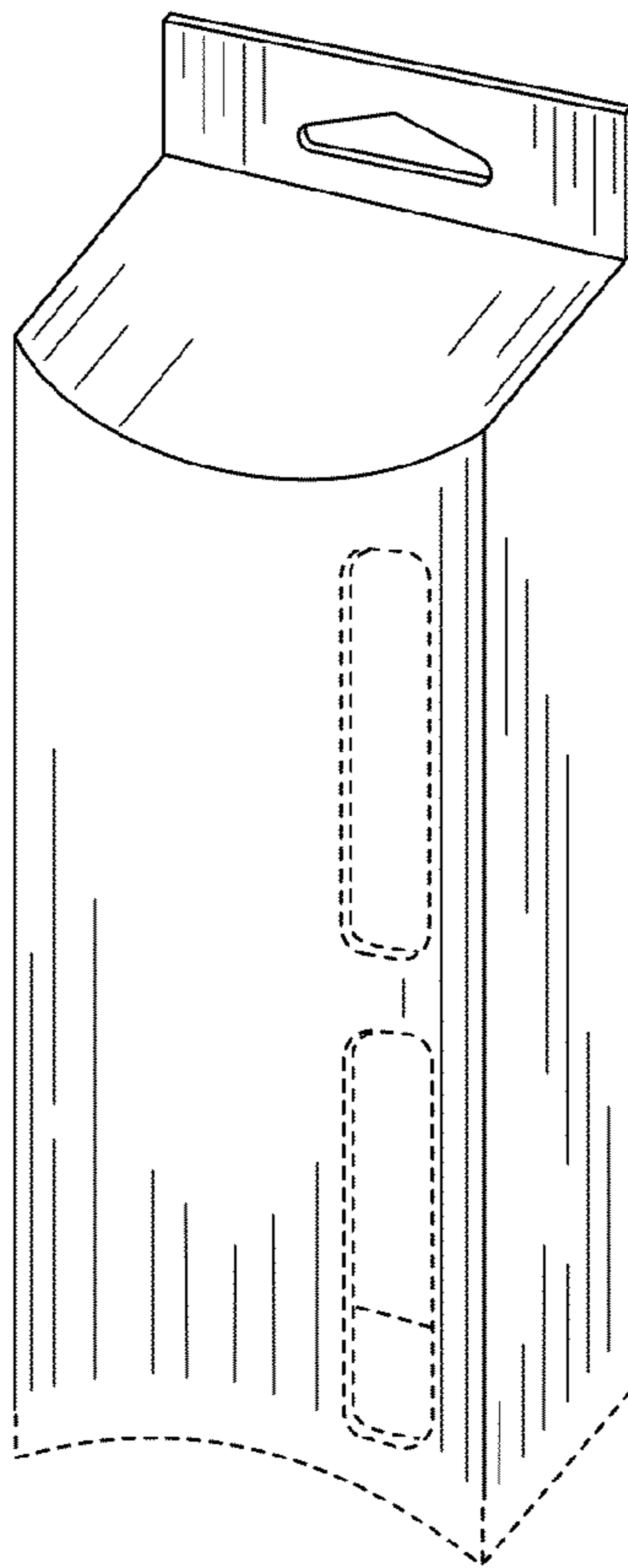

FIG. 1

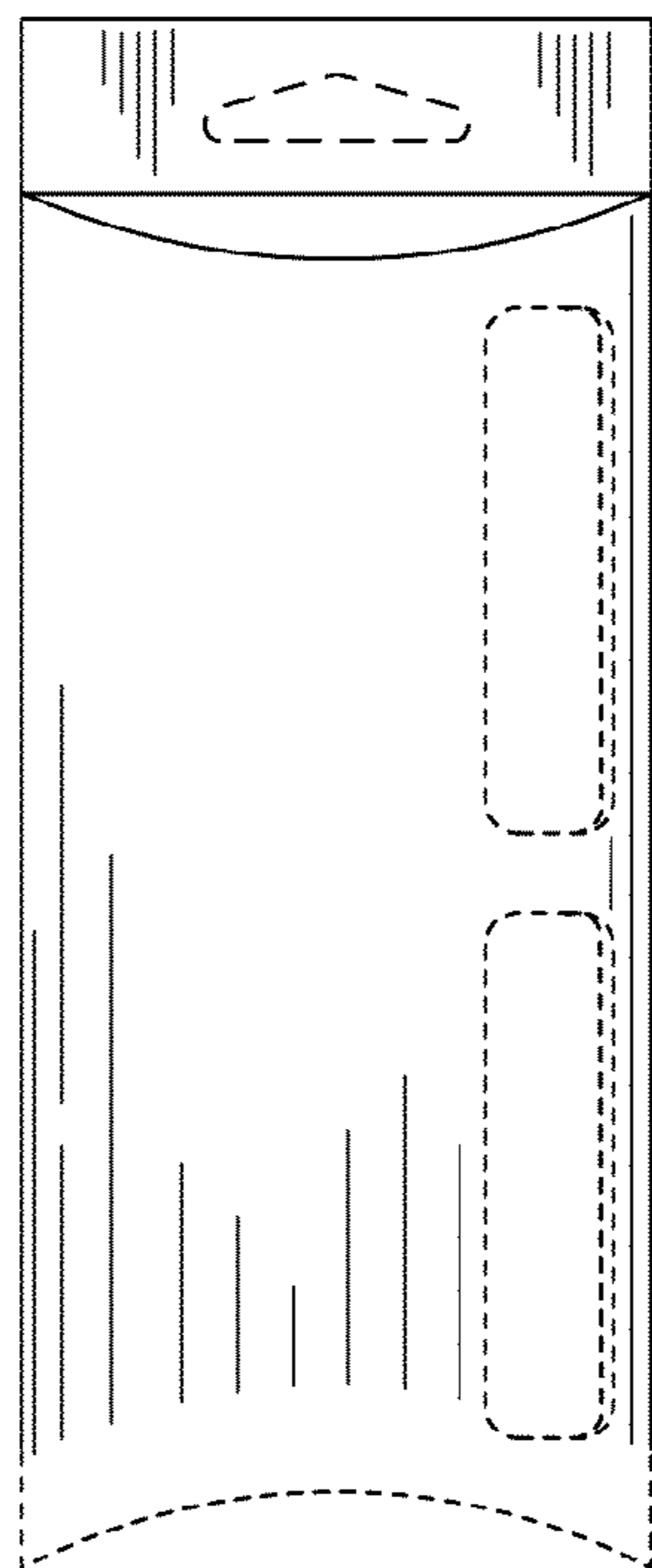

FIG. 2

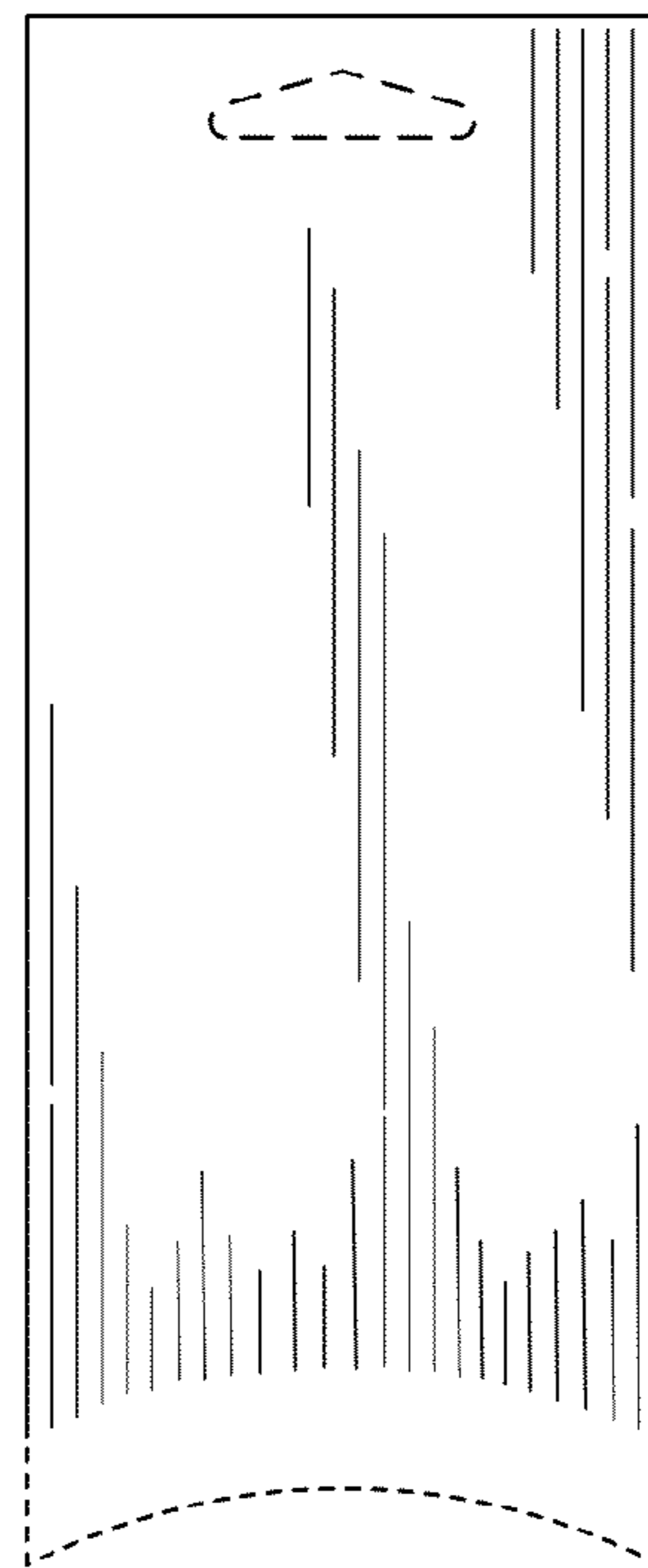

FIG. 3

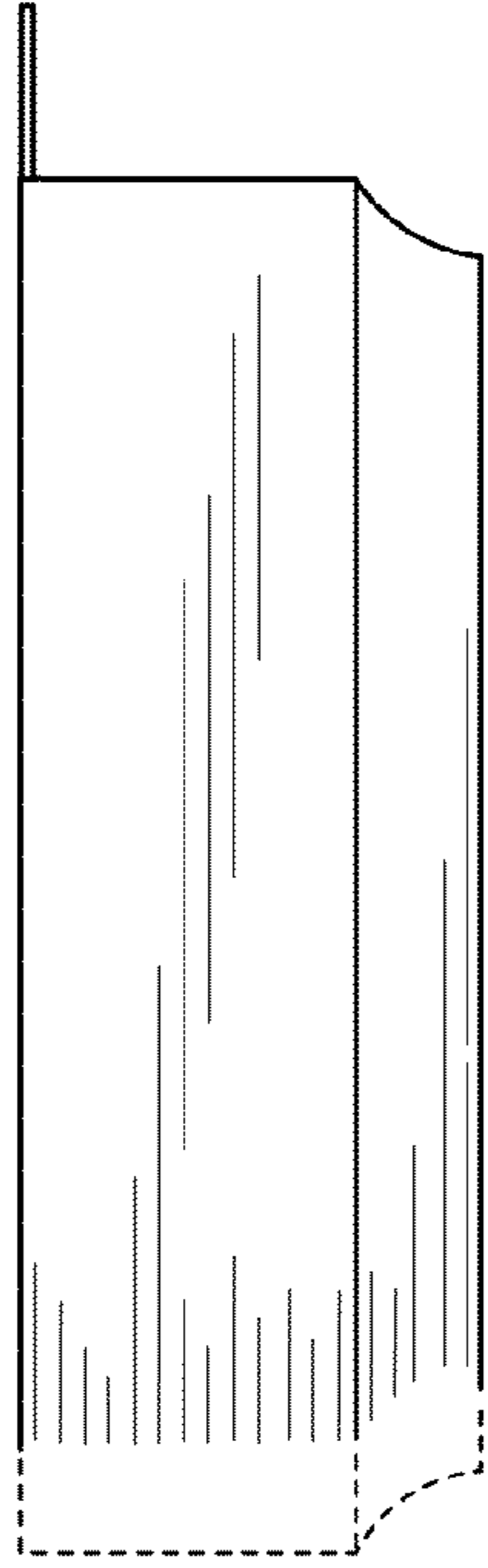

FIG. 4

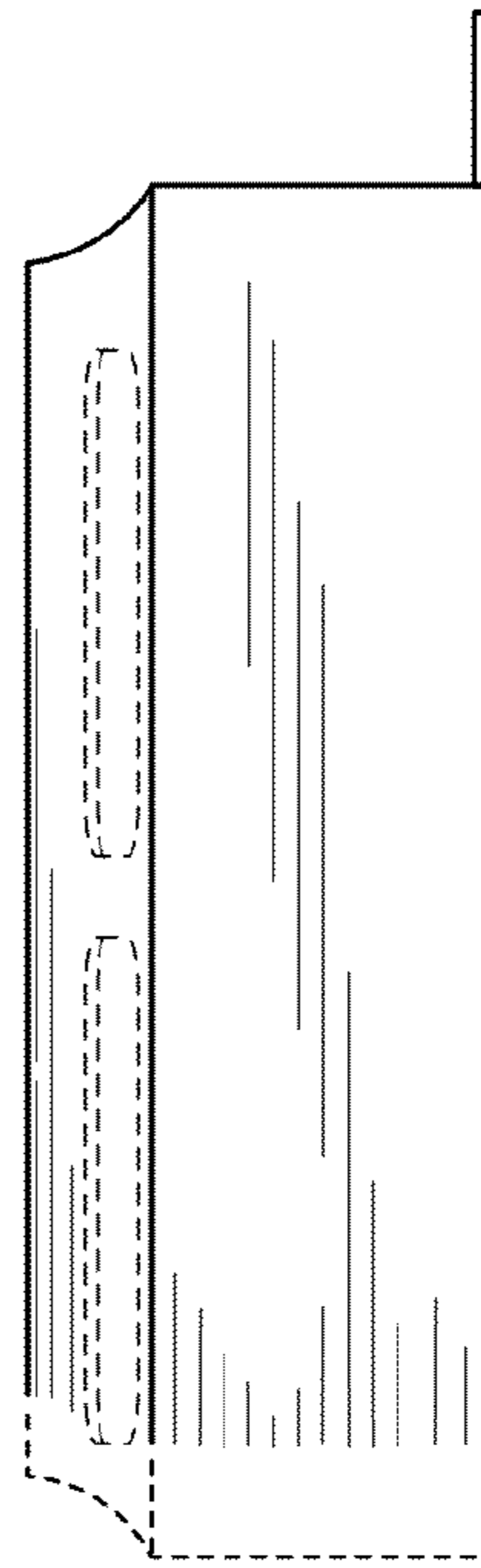

FIG. 5

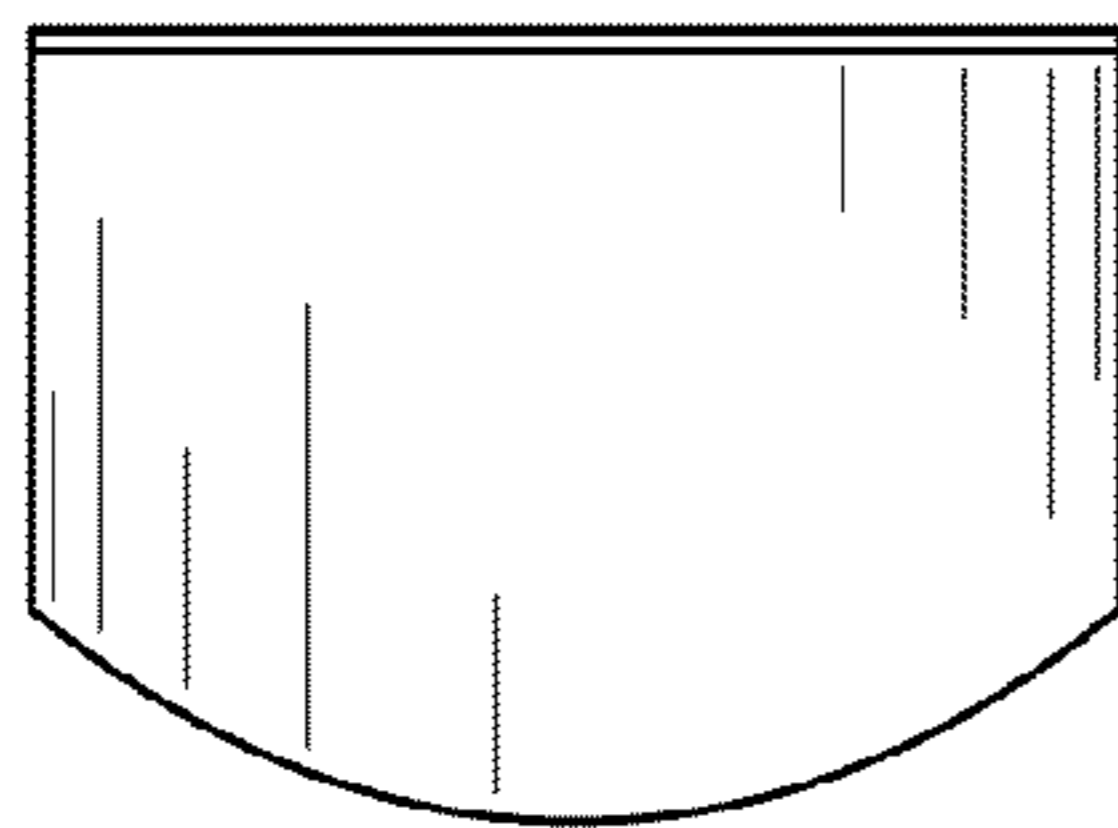

FIG. 6

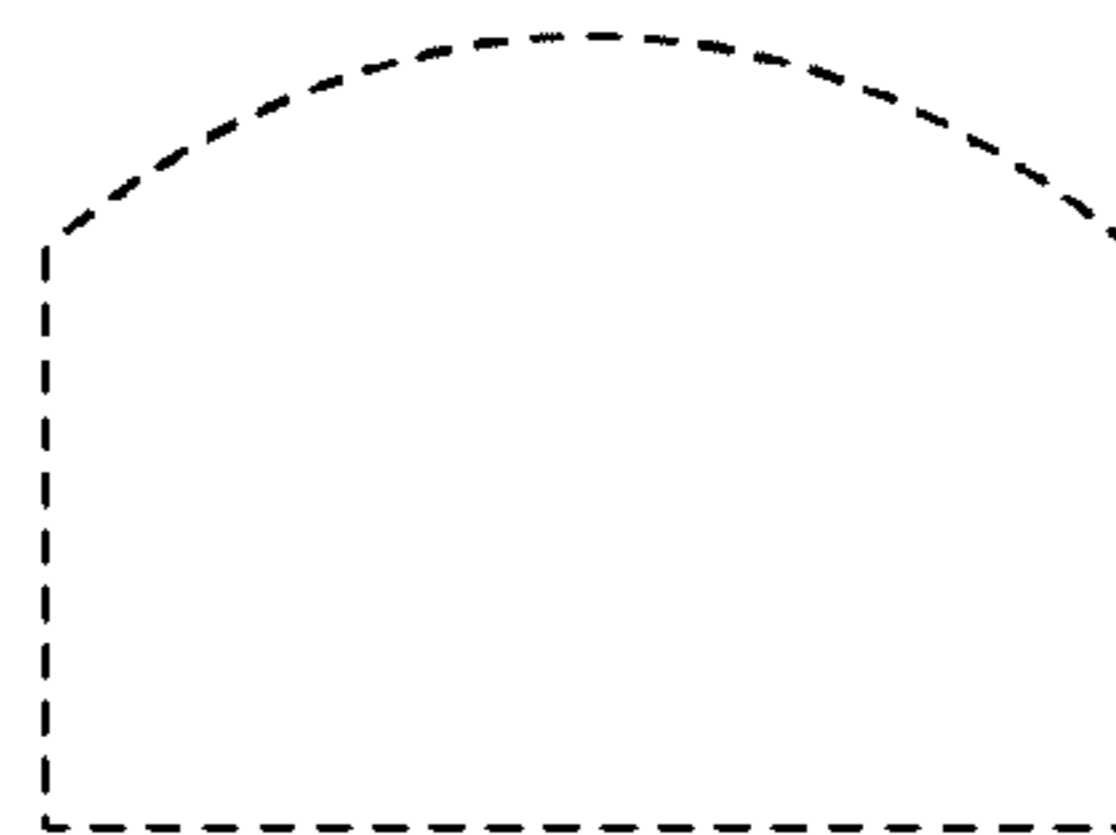

FIG. 7

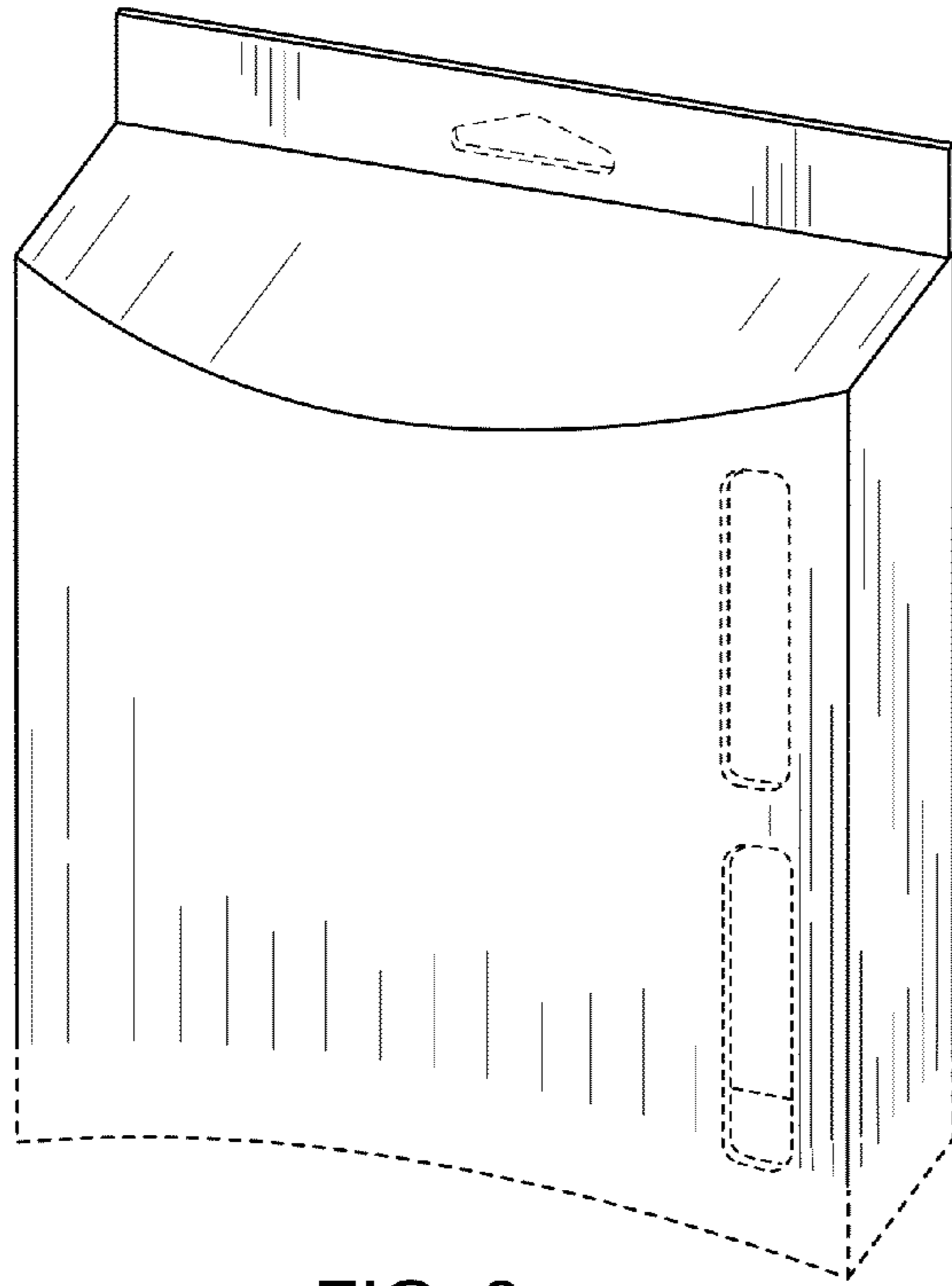

FIG. 8

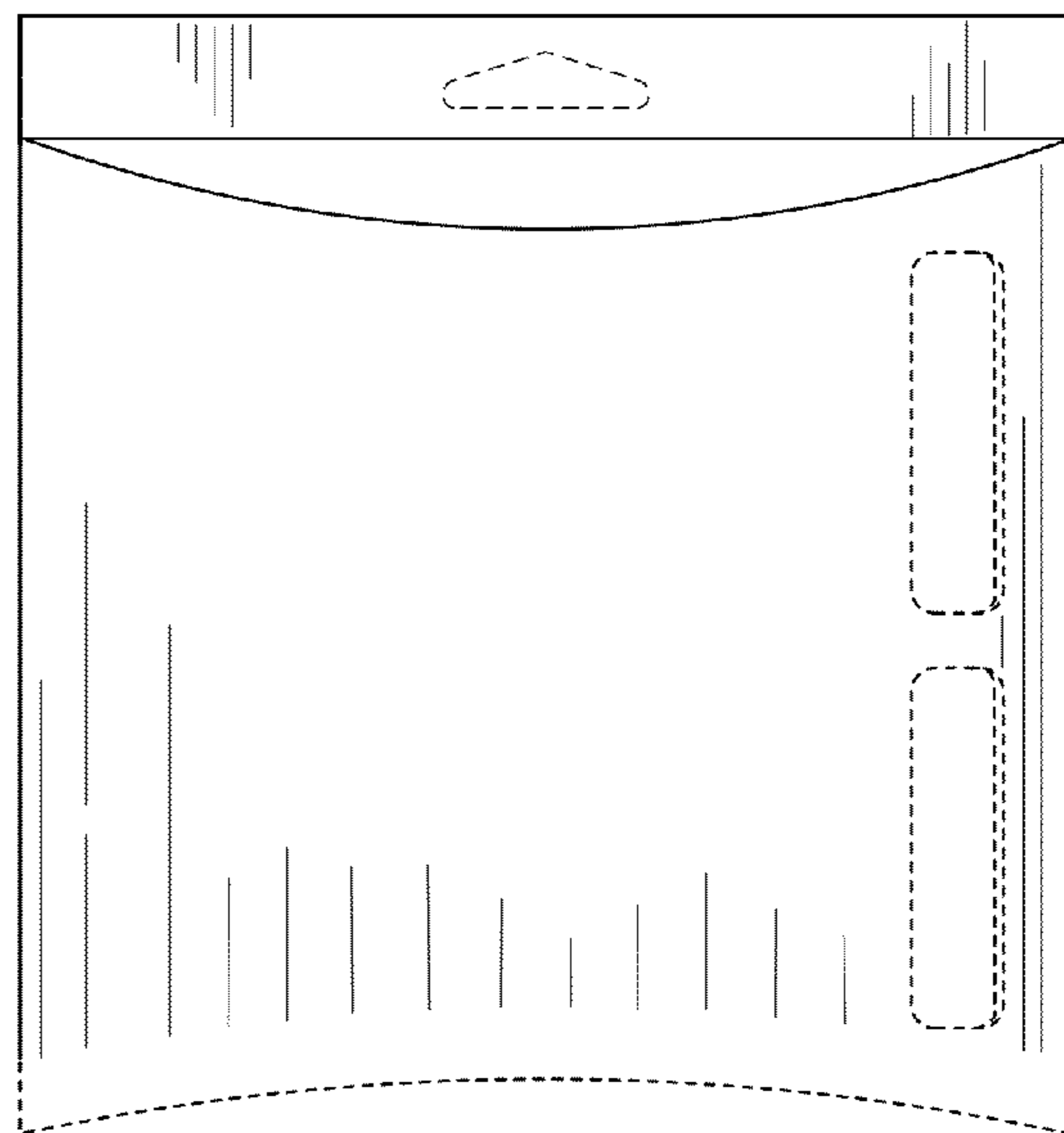

FIG. 9

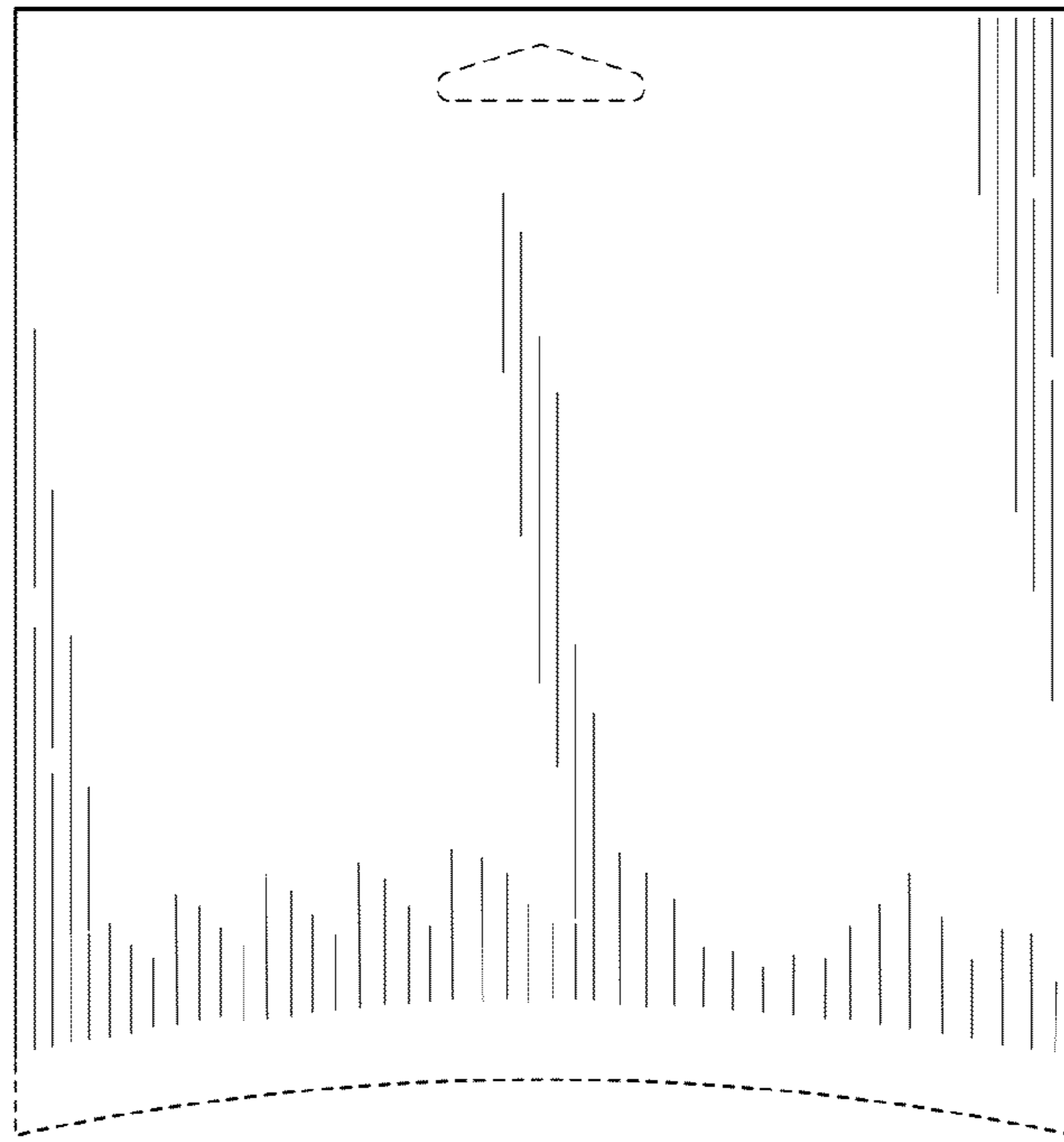

FIG. 10

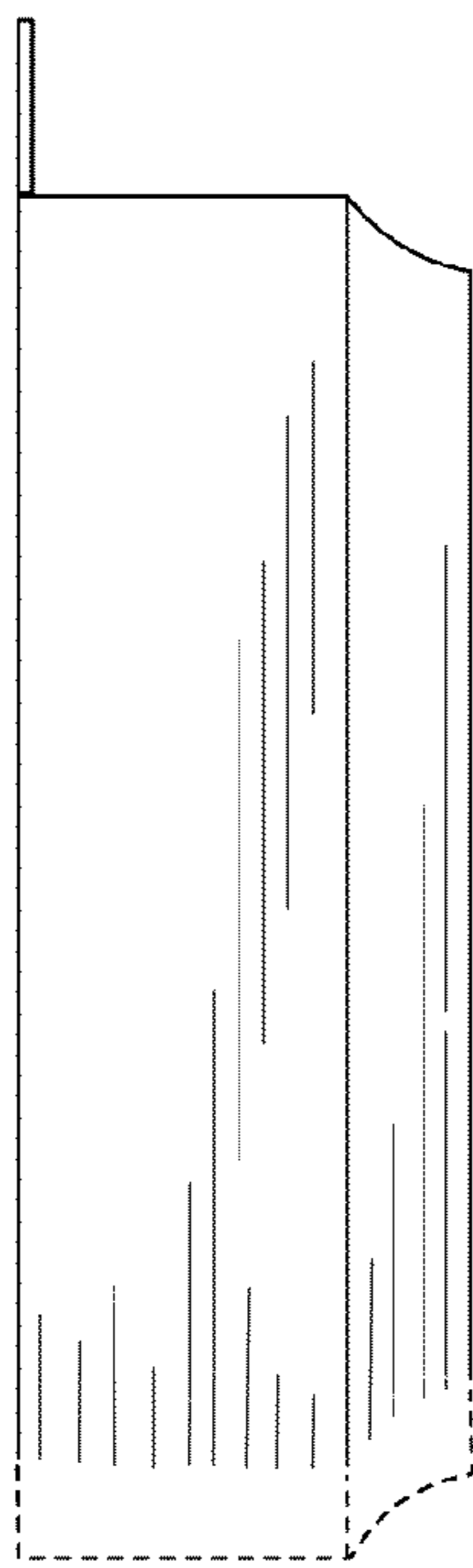

FIG. 11

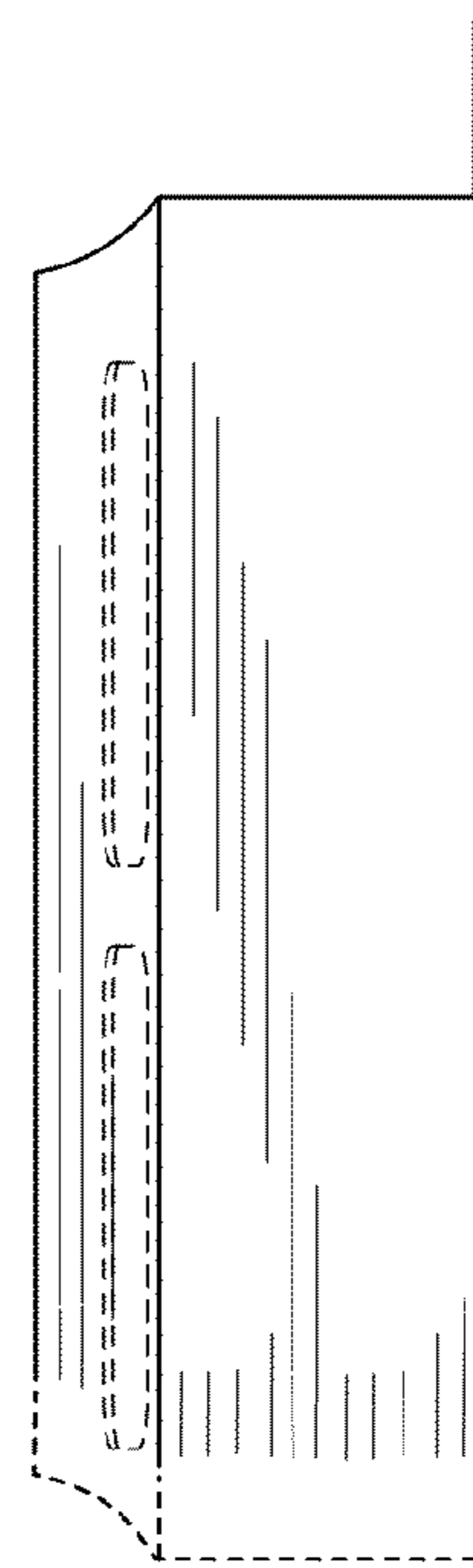

FIG. 12

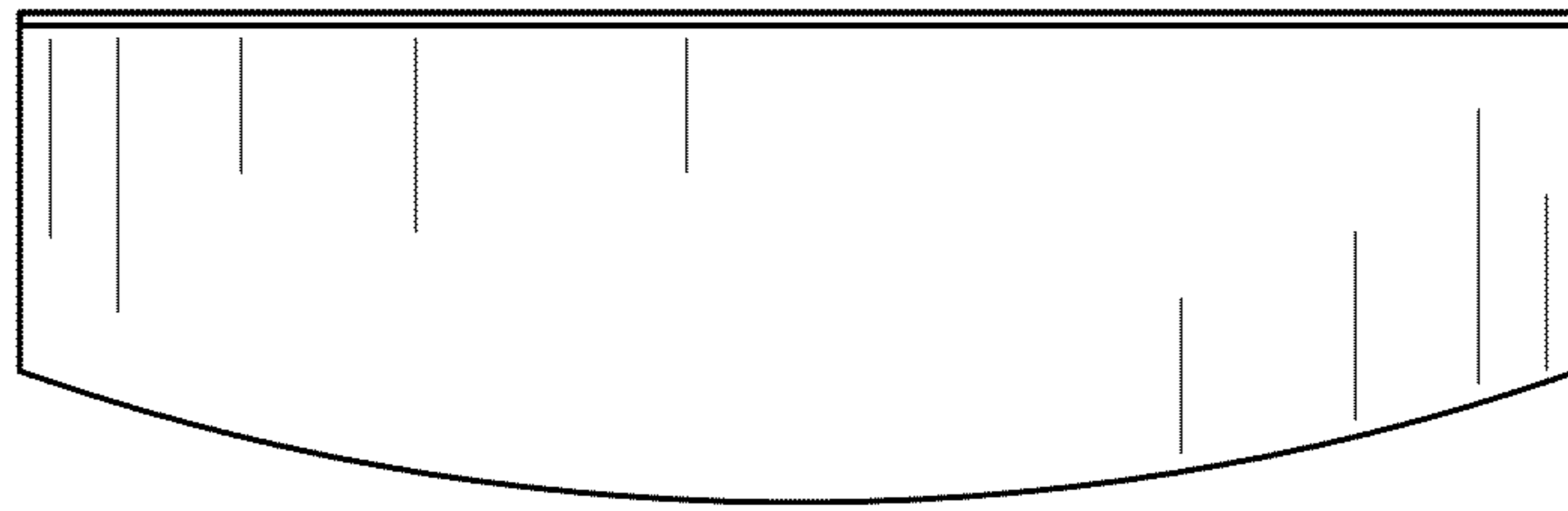

FIG. 13



FIG. 14