



US00D711183S

(12) **United States Design Patent**  
**Bernheim**

(10) **Patent No.:** **US D711,183 S**  
(45) **Date of Patent:** **\*\* Aug. 19, 2014**

- (54) **WATER BASIN FOR COOKING**
- (71) Applicant: **Joshua Bernheim**, Carlsbad, CA (US)
- (72) Inventor: **Joshua Bernheim**, Carlsbad, CA (US)
- (\*\*) Term: **14 Years**
- (21) Appl. No.: **29/444,155**
- (22) Filed: **Jan. 26, 2013**
- (51) **LOC (10) Cl.** ..... **07-02**
- (52) **U.S. Cl.**  
USPC ..... **D7/360; D7/354**
- (58) **Field of Classification Search**  
USPC ..... D7/307, 323, 329–332, 339, 346–347,  
D7/350.1–350.4, 353–367, 391–392,  
D7/392.1, 393, 395, 402, 406, 409,  
D7/538–545, 584–587, 600–602, 610–611,  
D7/629, 665–667, 672; D9/424, 500–503;  
99/324–325, 330–343, 369, 400–418,  
99/422, 425, 426, 440, 451, 483; 126/37 R,  
126/261, 374.1, 378.1, 381.1, 385.1;  
206/501–505, 507–508; 219/400, 405,  
219/429–442, 620–624, 725, 730–735;  
220/203.05, 203.07, 203.09, 298,  
220/315–316, 573.1–573.5, 912; 426/438,  
426/441

See application file for complete search history.

(56) **References Cited**

**U.S. PATENT DOCUMENTS**

- 3,078,786 A \* 2/1963 Arvan ..... 99/407
- 3,225,681 A \* 12/1965 Wells ..... 99/336

- 4,951,558 A \* 8/1990 Figliuzzi ..... 99/336
- 5,746,117 A \* 5/1998 Chang ..... 99/407
- 6,250,213 B1 \* 6/2001 De'Longhi ..... 99/407
- 6,499,390 B1 \* 12/2002 Huang ..... 99/331
- D473,097 S \* 4/2003 Brown et al. .... D7/354
- 7,015,429 B2 \* 3/2006 Lau et al. .... 219/441
- D532,248 S \* 11/2006 Allende Fritsch ..... D7/354
- 7,484,455 B2 \* 2/2009 De'Longhi ..... 99/330
- D672,600 S \* 12/2012 Berge ..... D7/354
- D674,651 S \* 1/2013 Berge ..... D7/354
- D680,802 S \* 4/2013 Seymour ..... D7/354

\* cited by examiner

*Primary Examiner* — Ricky Pham

(74) *Attorney, Agent, or Firm* — Steven W. Webb

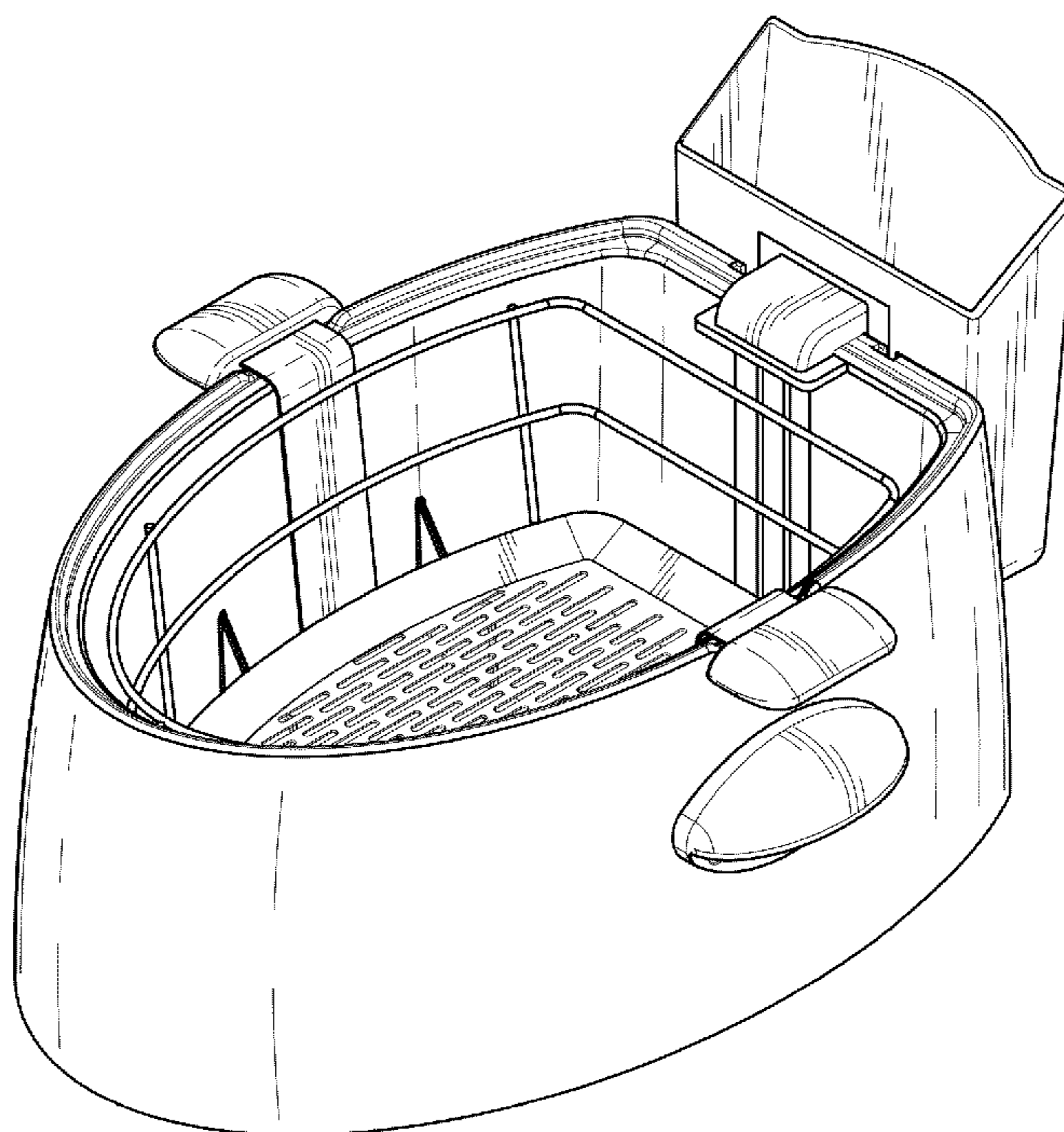
(57) **CLAIM**

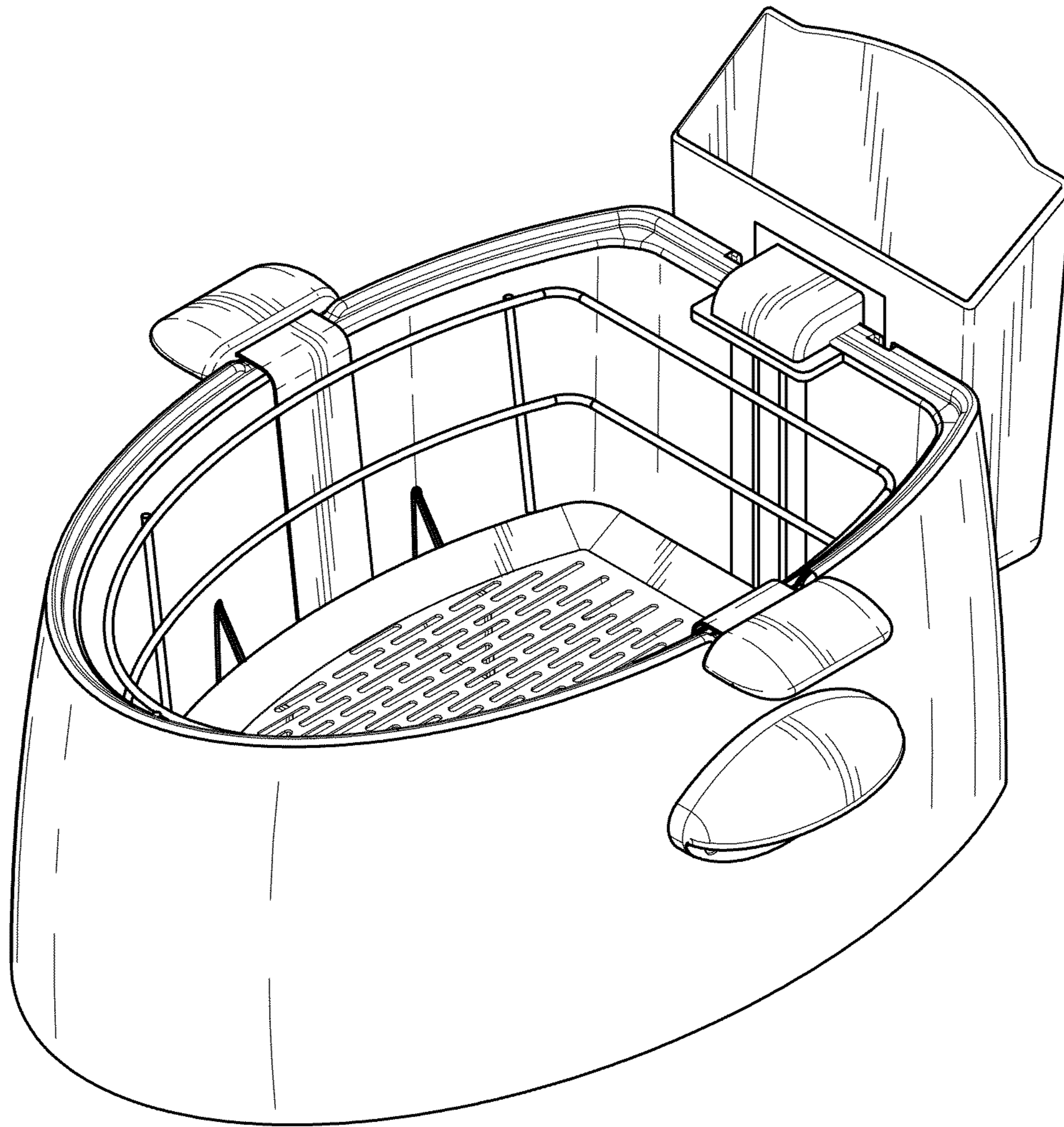
The ornamental design for a water basin for cooking, as shown and described.

**DESCRIPTION**

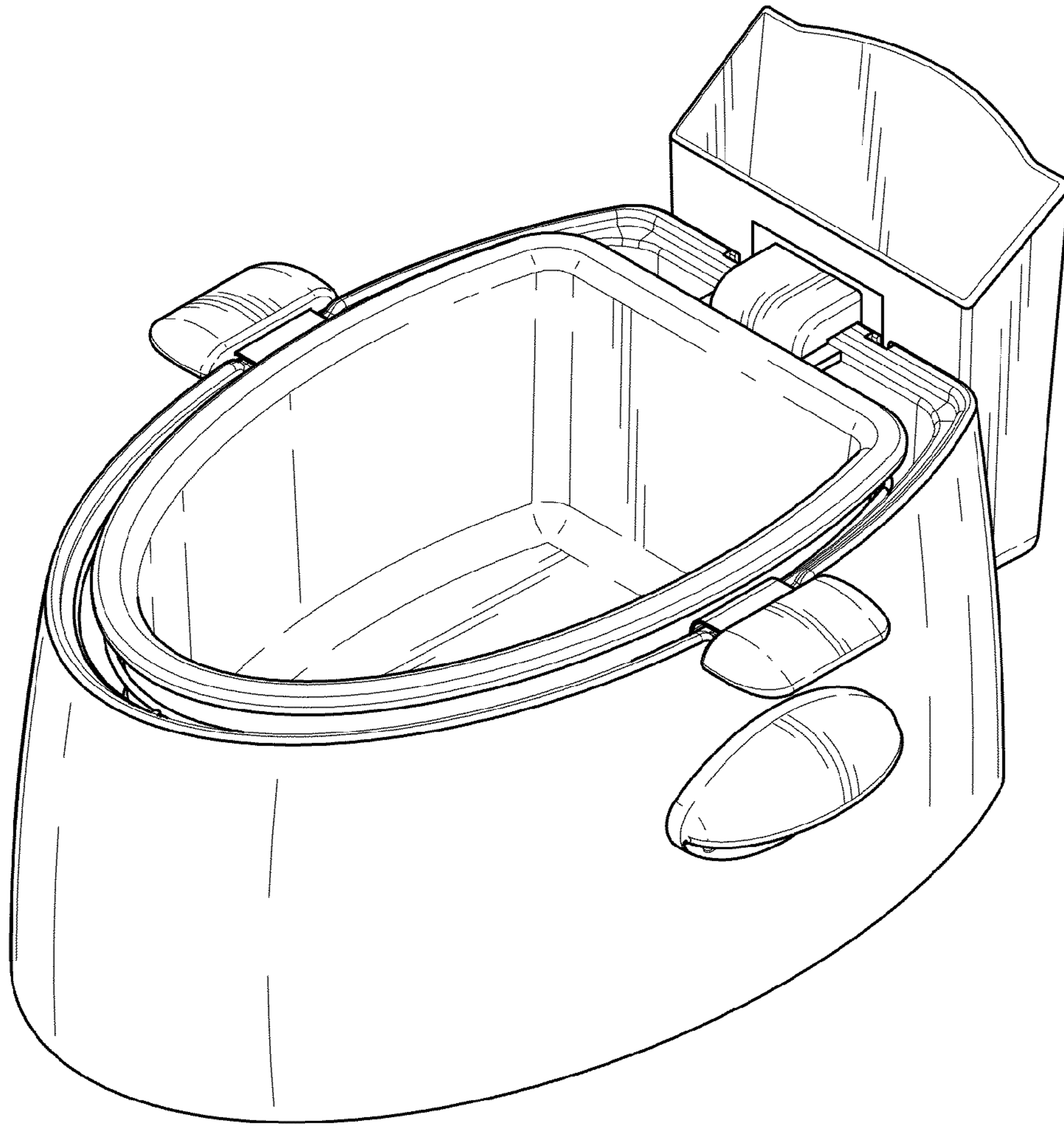
FIG. 1 is a perspective view of the invention.  
 FIG. 2 is a perspective view of the invention, shown without the frame and lid for clarity and completeness of disclosure.  
 FIG. 3 is perspective view of the invention shown without the liner and lid for clarity and completeness of disclosure.  
 FIG. 4 is a top view of the invention.  
 FIG. 5 is the side view of the invention with the lid.  
 FIG. 6 is the front view of the invention with the lid.  
 FIG. 7 is a perspective view of the frame, shown separately for ease of illustration; and,  
 FIG. 8 is a top view of the frame of FIG. 7.  
 The water basin for cooking, as shown. The portions shown in the drawings as broken lines form no part of the claimed design.

**1 Claim, 6 Drawing Sheets**



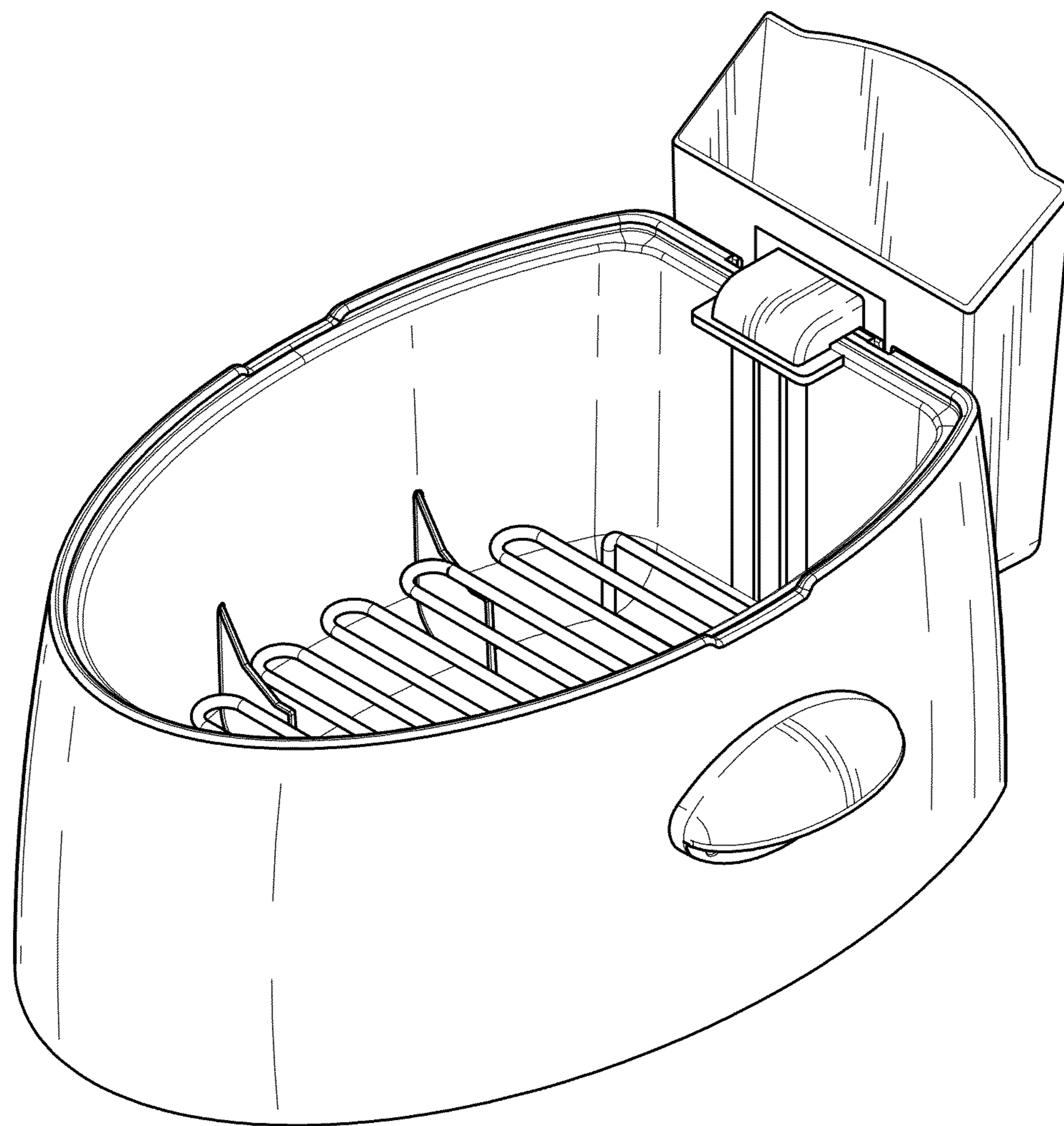


**FIG. 1**

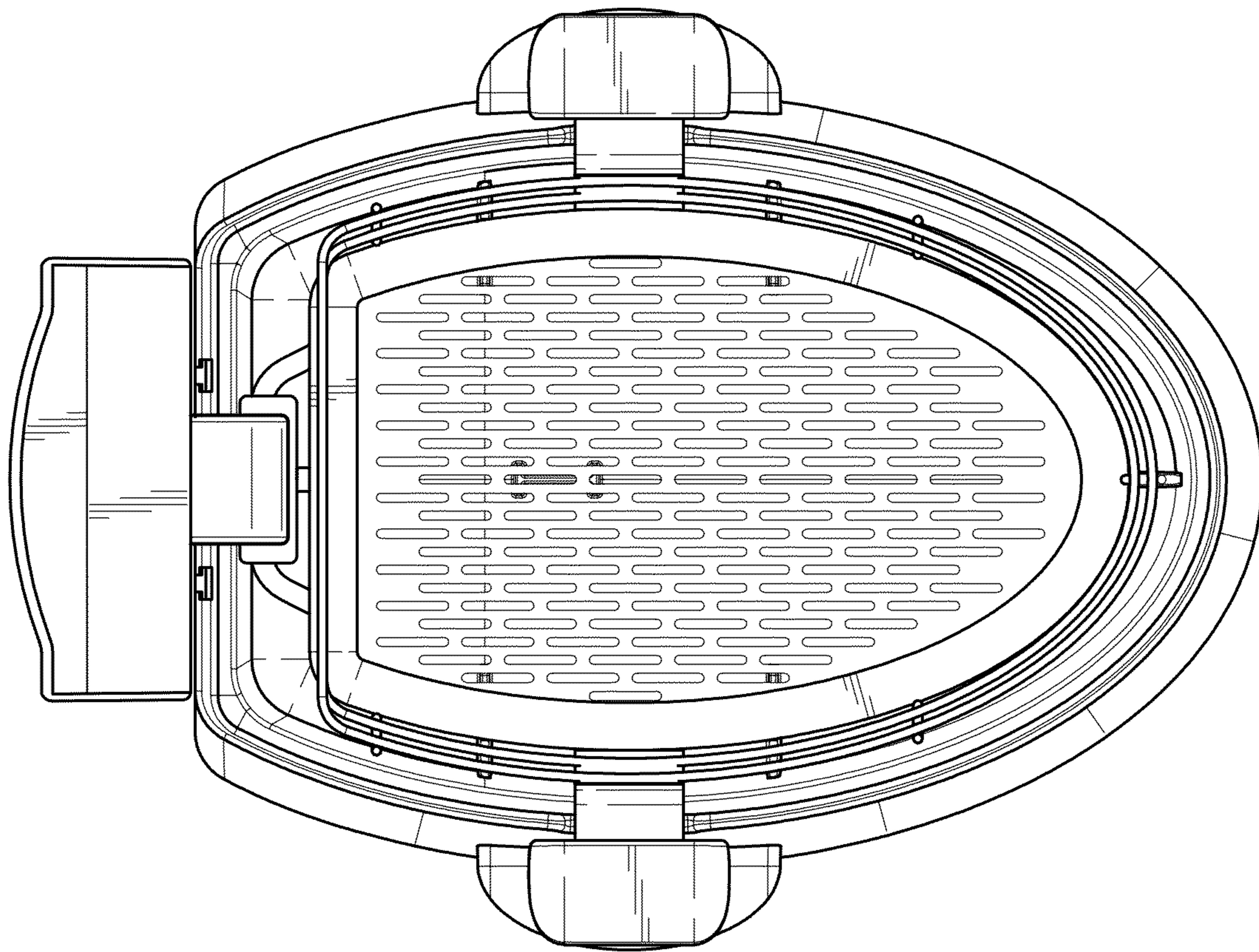


**FIG. 2**

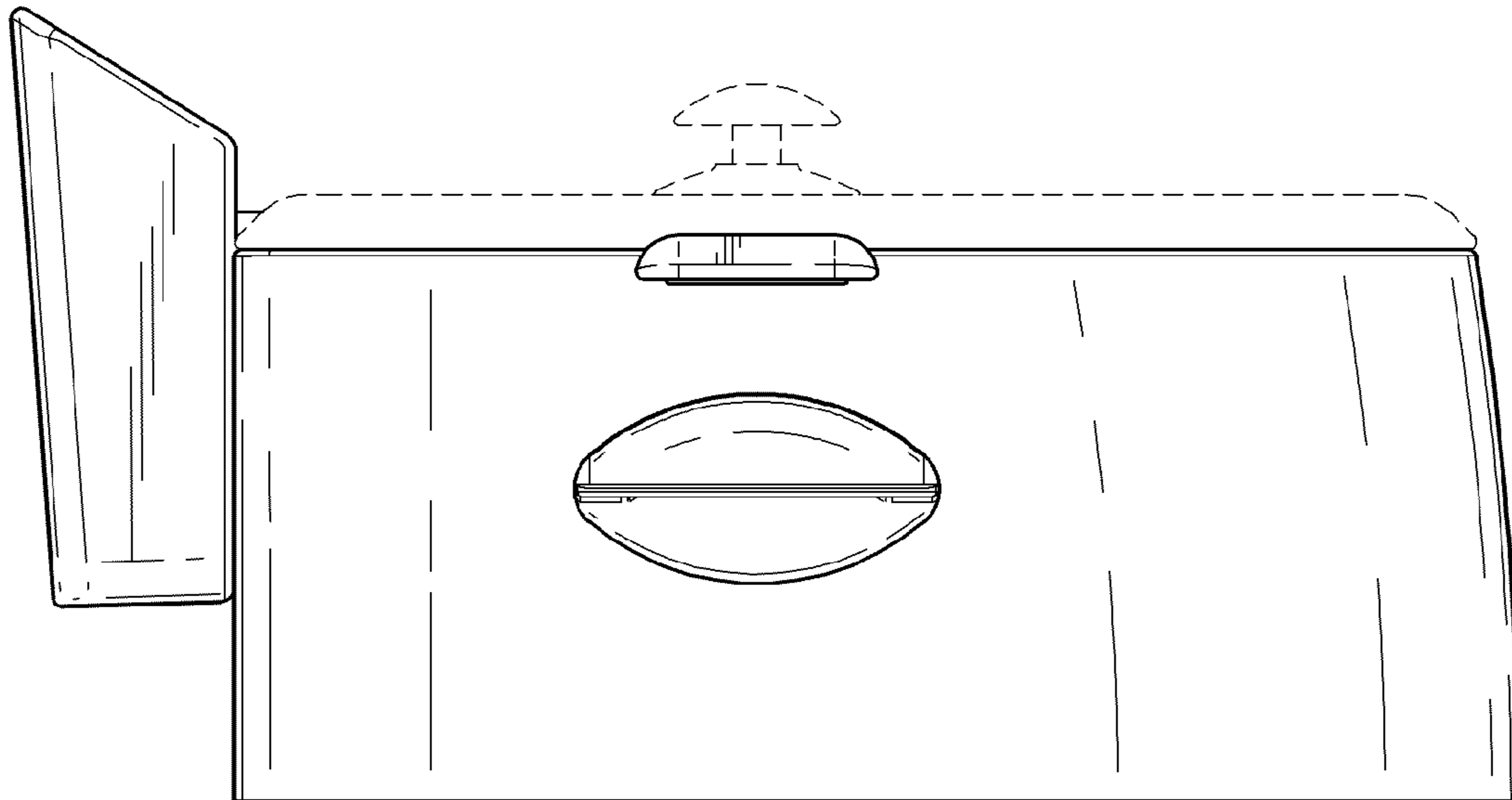




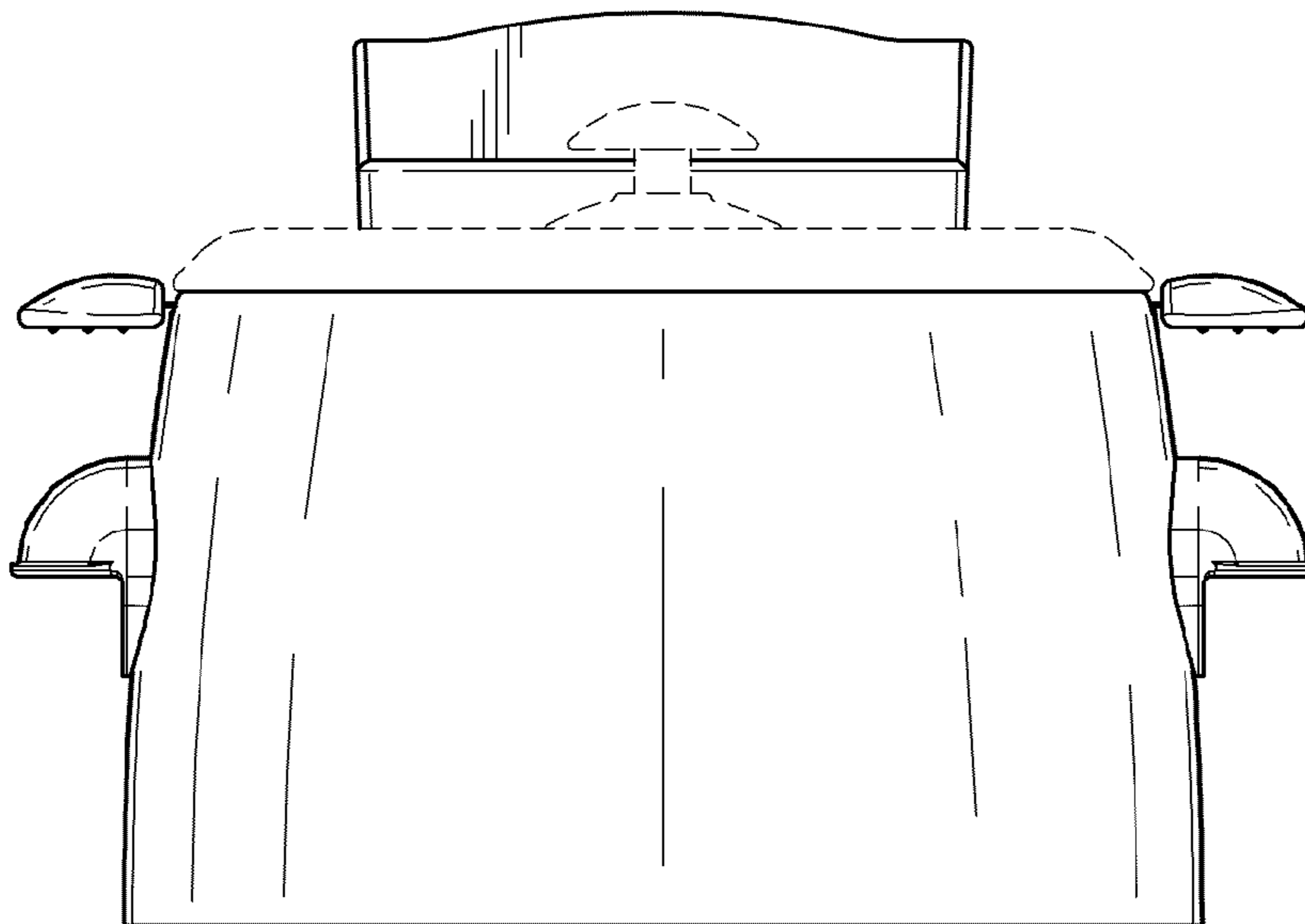
**FIG. 3**



**FIG. 4**

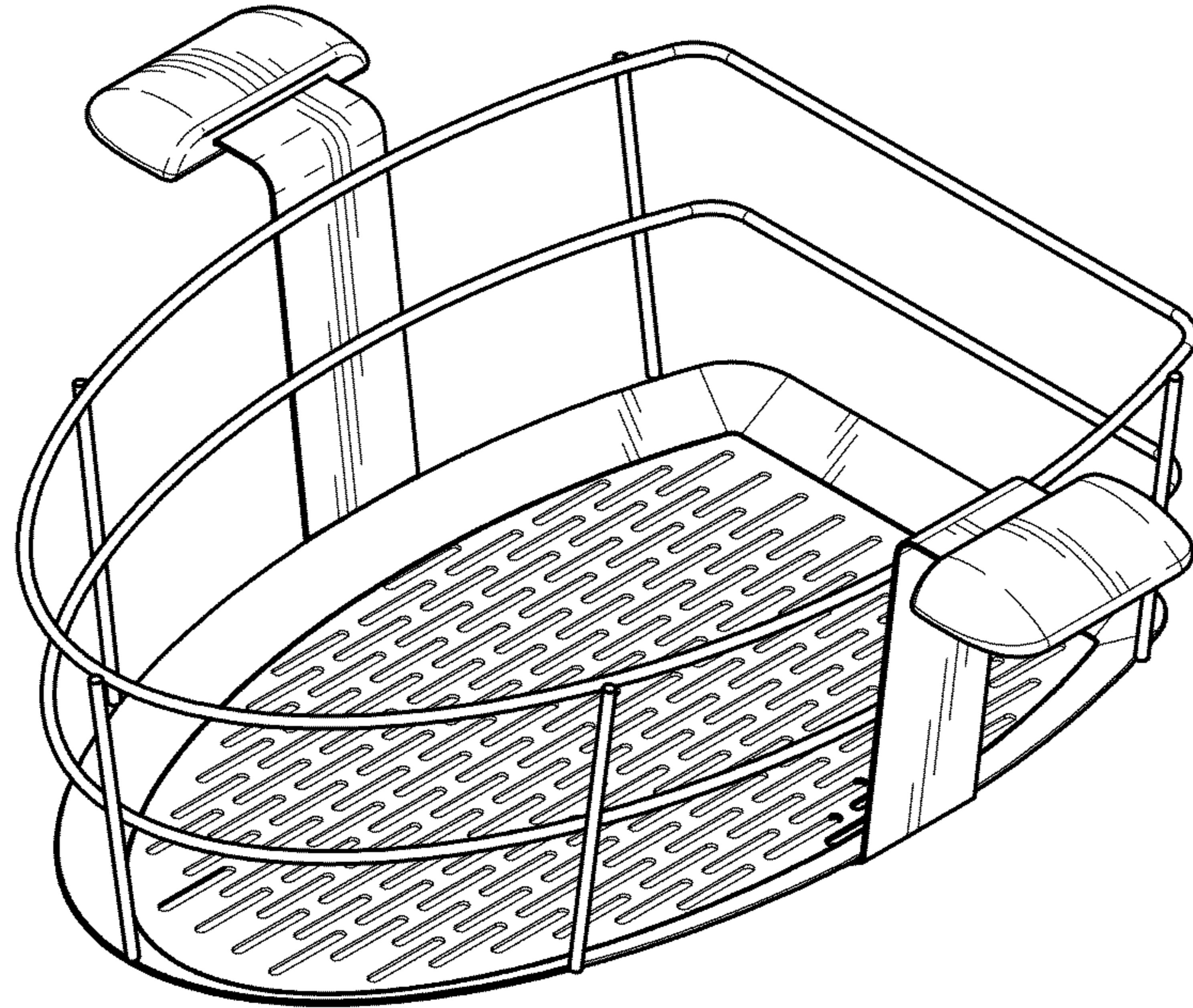


**FIG. 5**

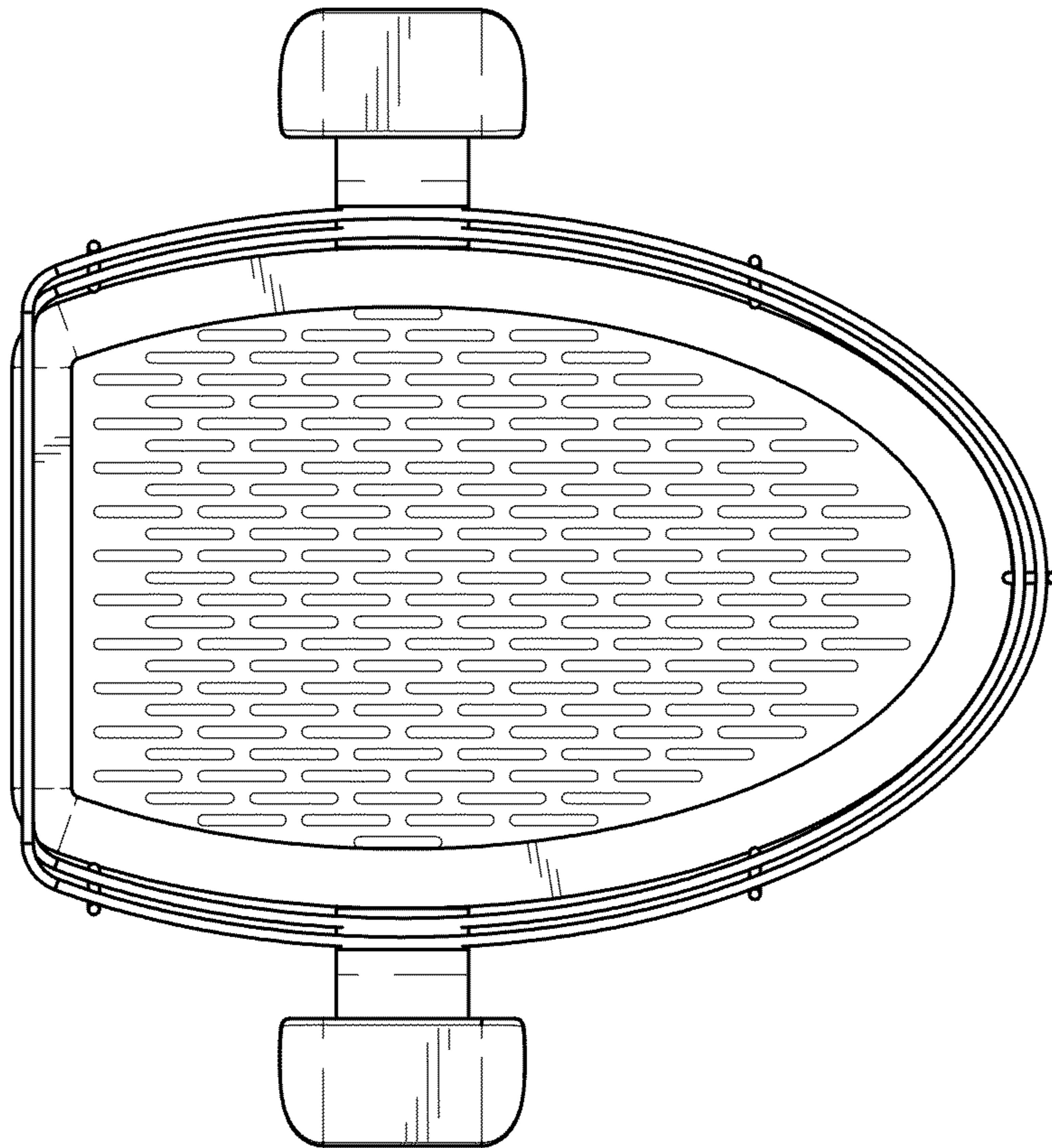


**FIG. 6**





**FIG. 7**



**FIG. 8**