



US00D711094S

(12) **United States Design Patent**
Simons

(10) **Patent No.:** **US D711,094 S**

(45) **Date of Patent:** **** Aug. 19, 2014**

(54) **HANDBAG**

(71) Applicant: **Christian Dior Couture, S.A.**, Paris (FR)

(72) Inventor: **Raf Simons**, Paris (FR)

(73) Assignee: **Christian Dior Couture, S.A.**, Paris (FR)

(**) Term: **14 Years**

(21) Appl. No.: **29/450,868**

(22) Filed: **Mar. 25, 2013**

(30) **Foreign Application Priority Data**

Nov. 23, 2012 (WO) DM/079672

(51) **LOC (10) Cl.** **03-01**

(52) **U.S. Cl.**
USPC **D3/232**

(58) **Field of Classification Search**
USPC D3/232-233, 240-243, 245-246;
150/100, 103-110, 113-114, 117-119
See application file for complete search history.

(56) **References Cited**

U.S. PATENT DOCUMENTS

D463,118 S * 9/2002 Tucker D3/246
D668,041 S * 10/2012 Kriemler D3/232

* cited by examiner

Primary Examiner — Holly Baynham

(74) *Attorney, Agent, or Firm* — Amster, Rothstein & Ebenstein, LLP

(57) **CLAIM**

The ornamental design for a handbag, as shown and described.

DESCRIPTION

FIG. 1 is a front perspective view of my invention, shown in its closed configuration;
FIG. 2 is a front elevational view thereof;
FIG. 3 is a right side elevational view thereof, the left side elevational view being the mirror image thereof;
FIG. 4 is a top plan view thereof;
FIG. 5 is a bottom plan view thereof;
FIG. 6 is a front perspective view of my invention, shown in its open configuration;
FIG. 7 is a front elevational view thereof, shown in its open configuration;
FIG. 8 is a right side elevational view thereof, shown in its open configuration;
FIG. 9 is a left side elevational view thereof, shown in its open configuration;
FIG. 10 is a top plan view thereof, shown in its open configuration; and,
FIG. 11 is a bottom plan view thereof, shown in its open configuration.

1 Claim, 10 Drawing Sheets

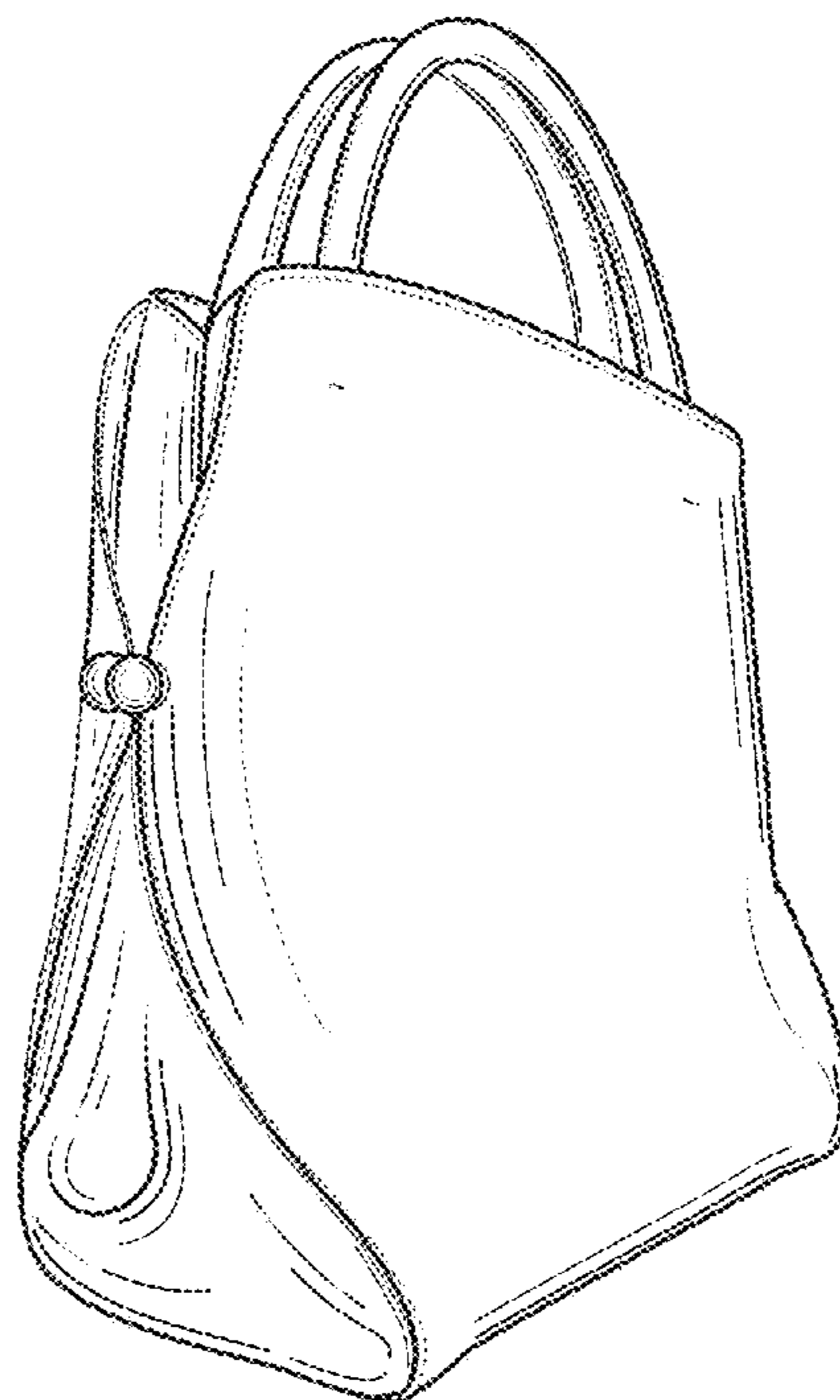

FIG. 1

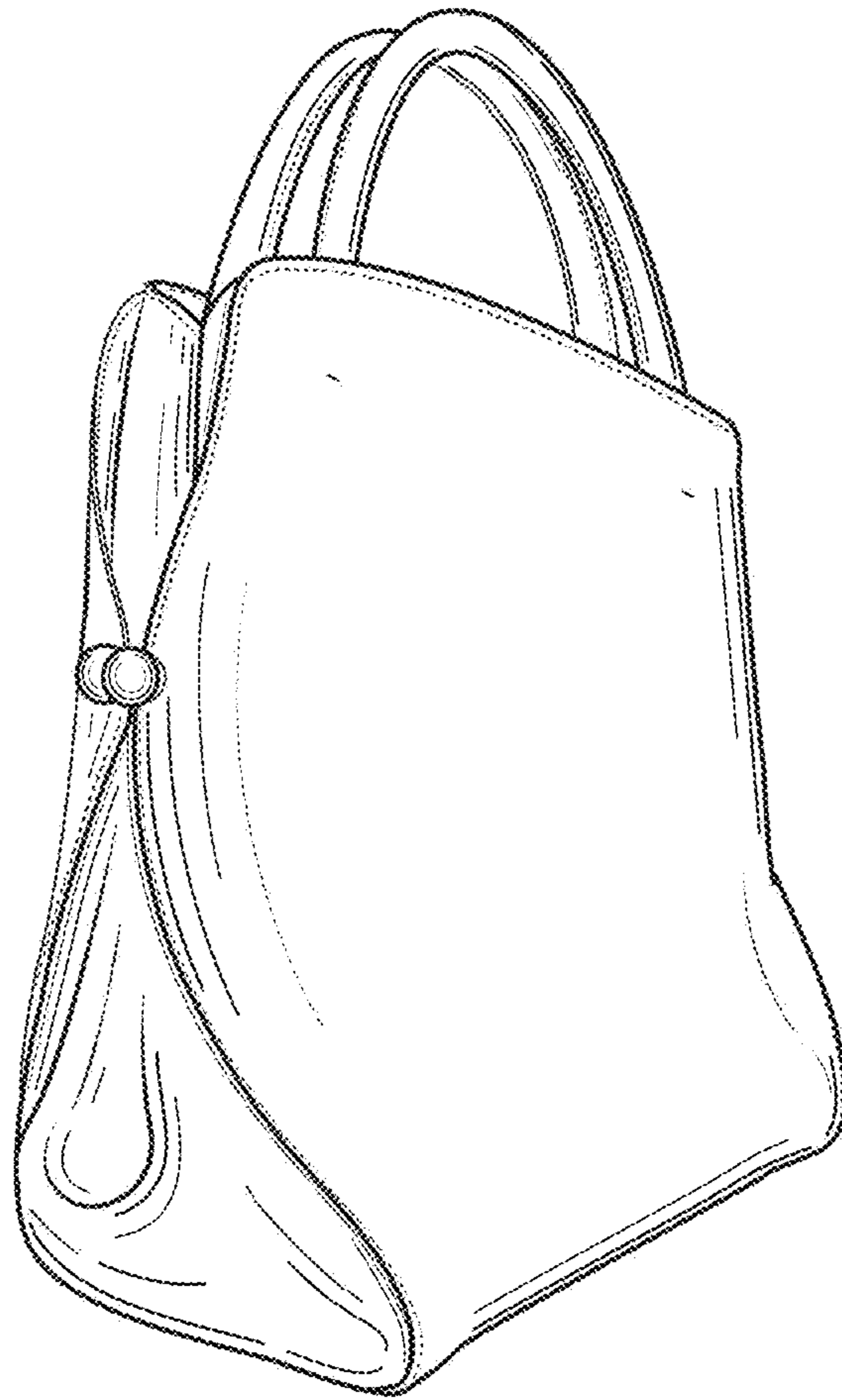

FIG. 2



FIG. 3

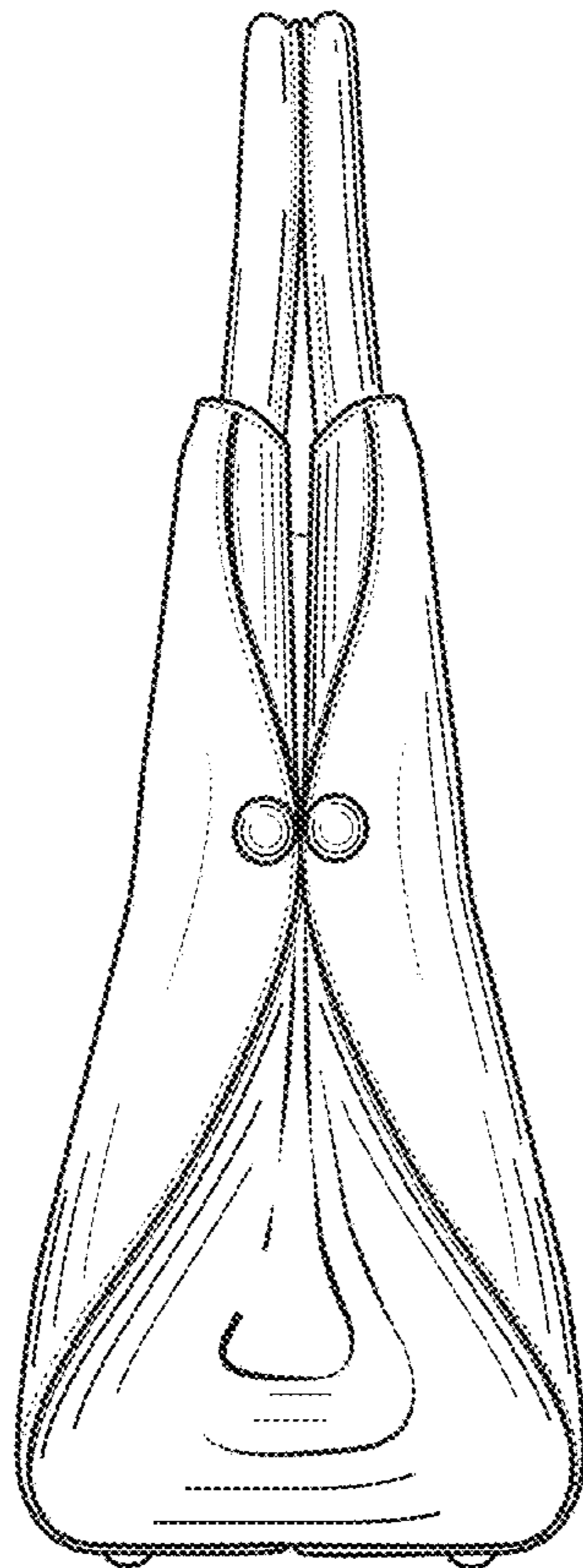

FIG. 4

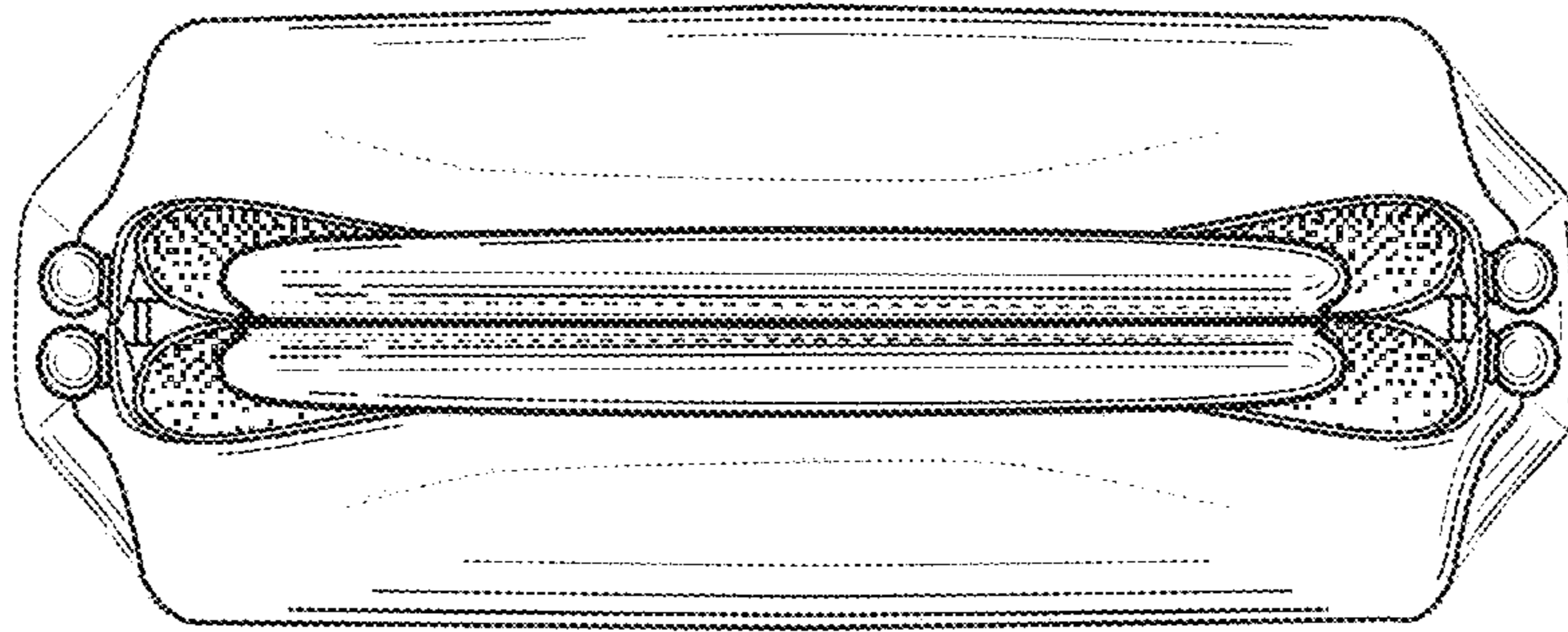

FIG. 5

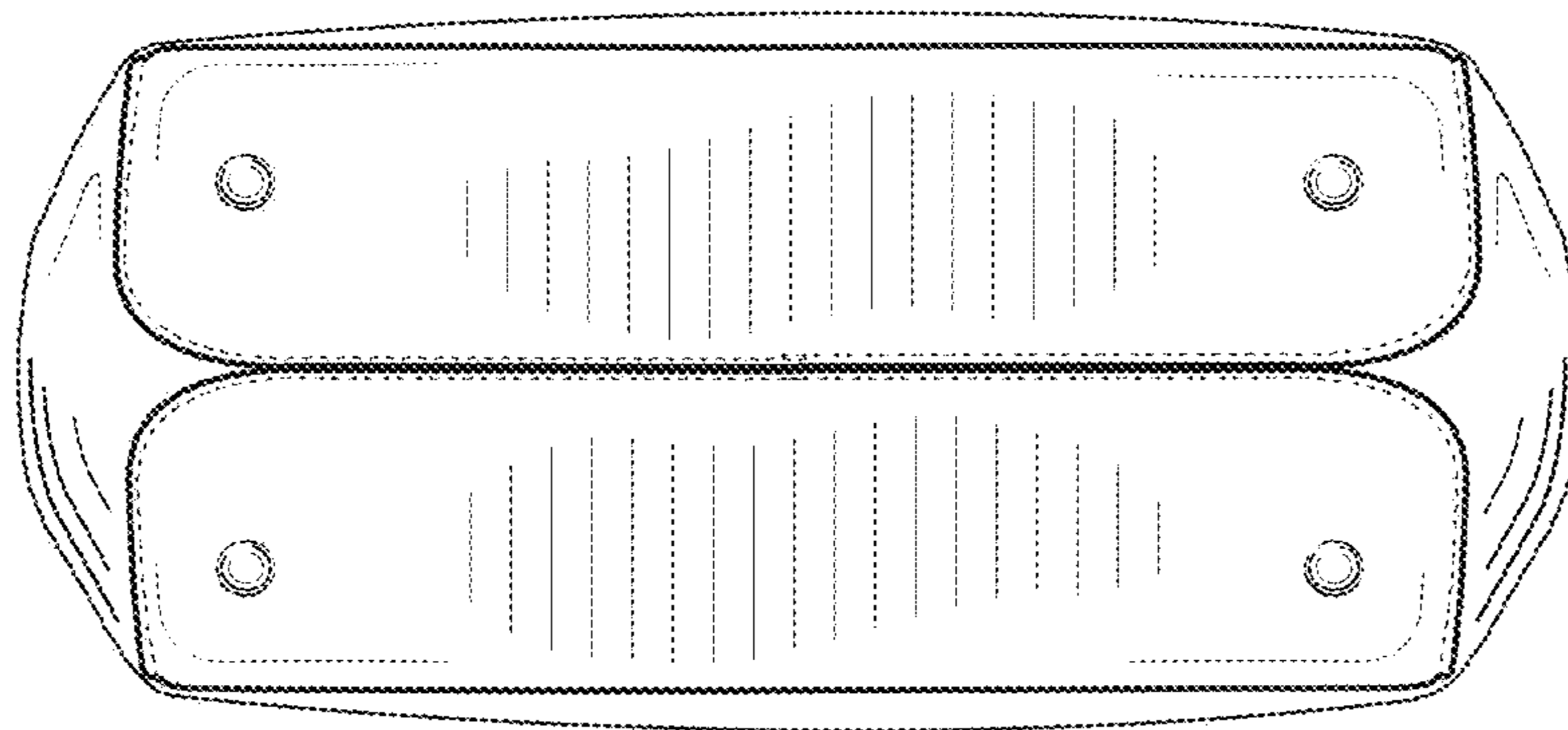

FIG. 6

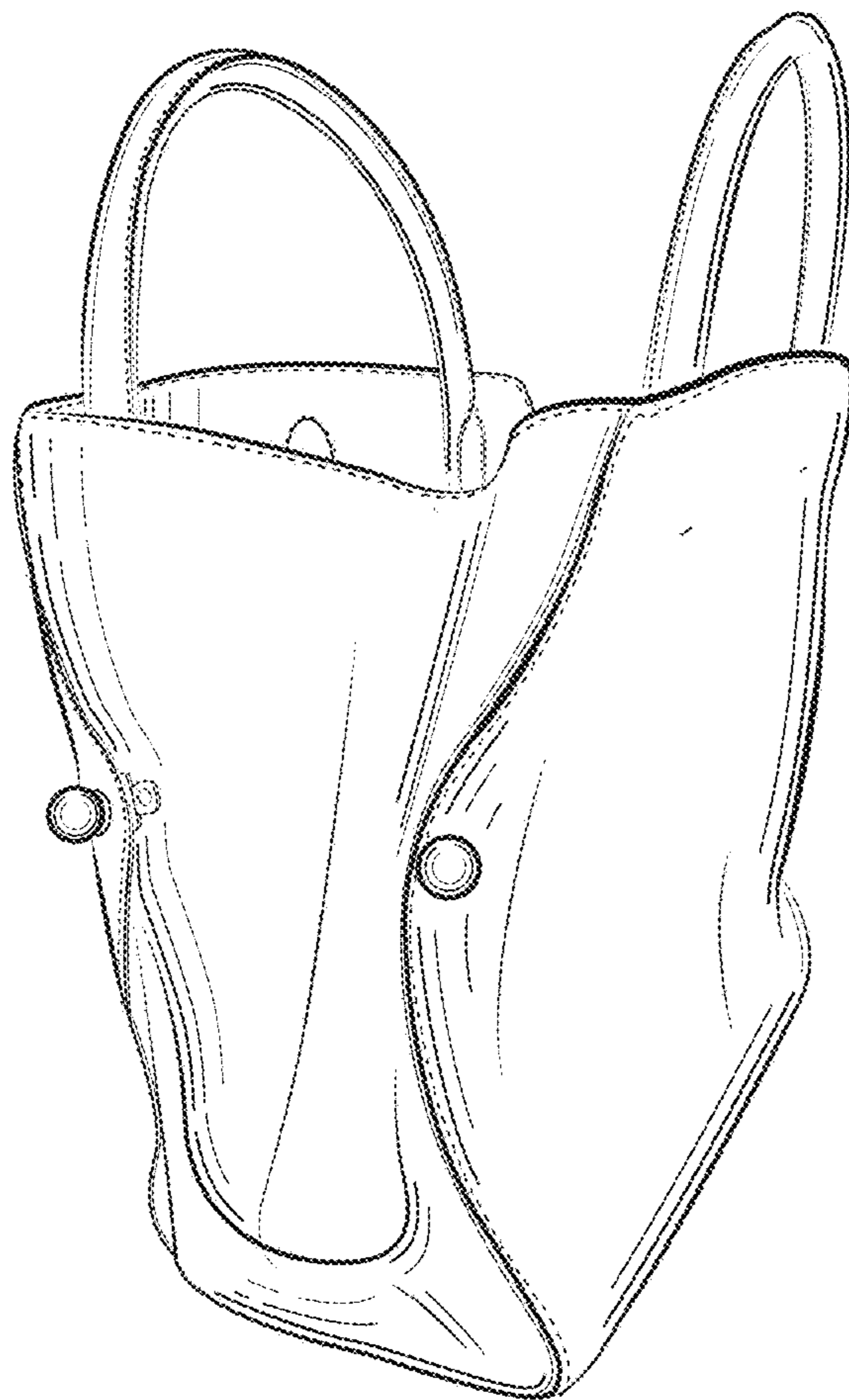

FIG. 7

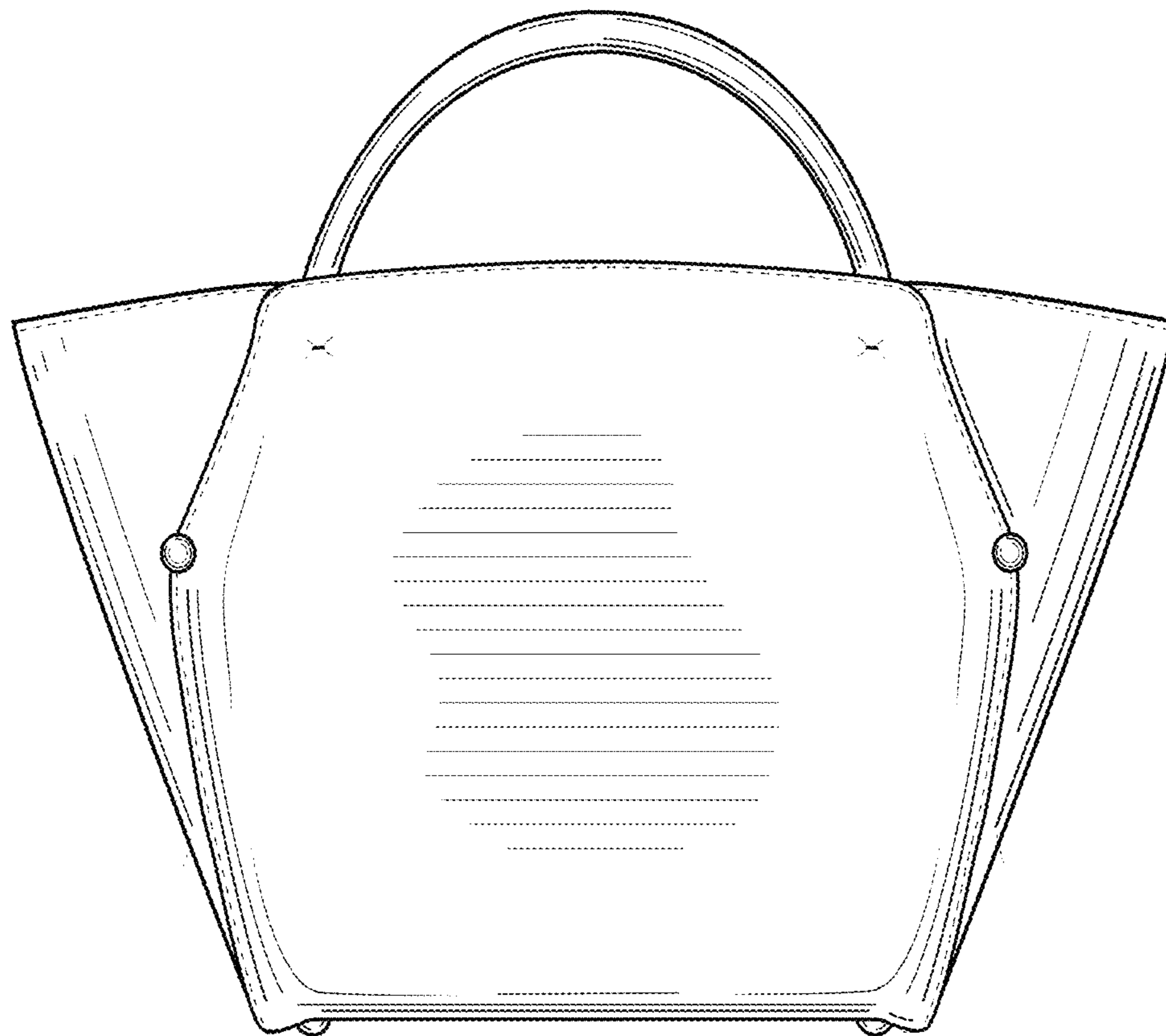

FIG. 8

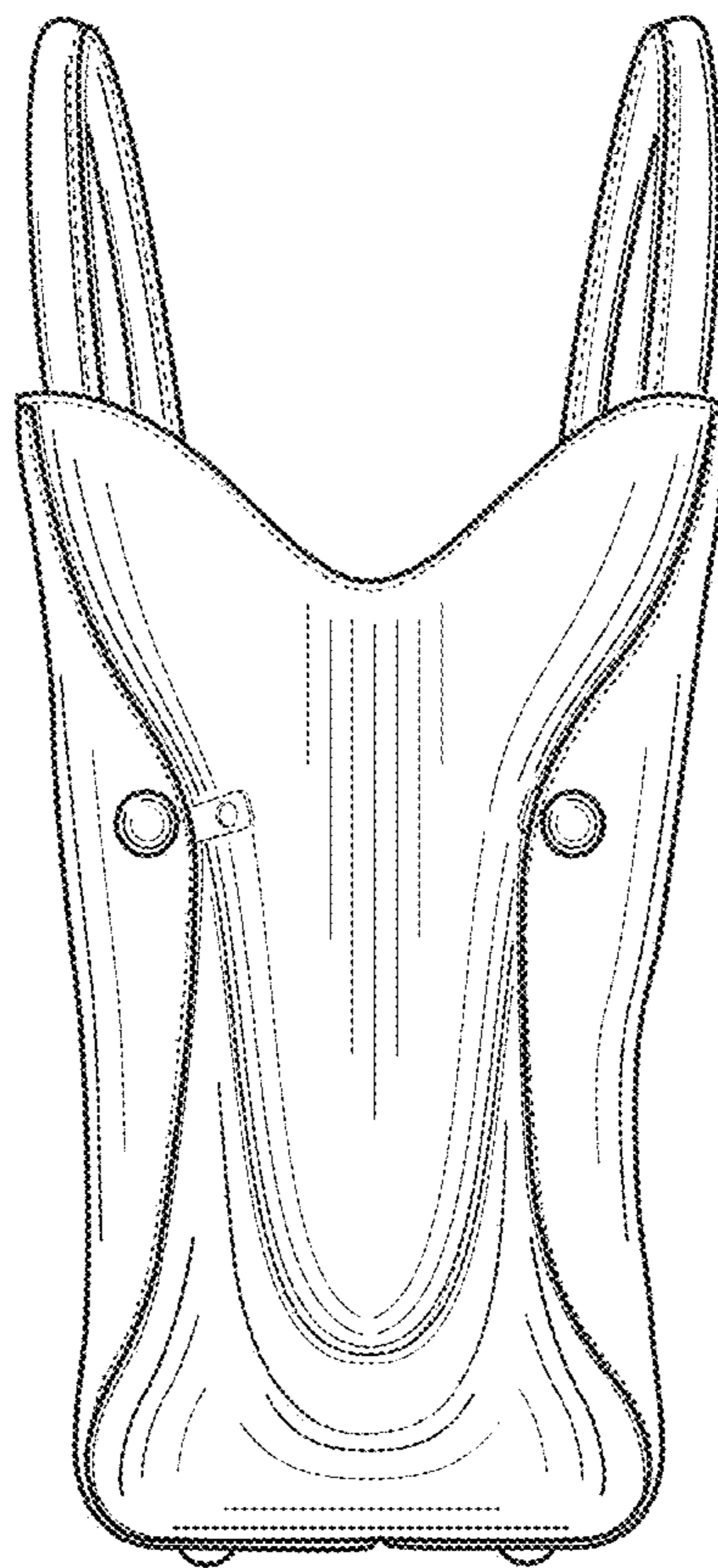

FIG. 9

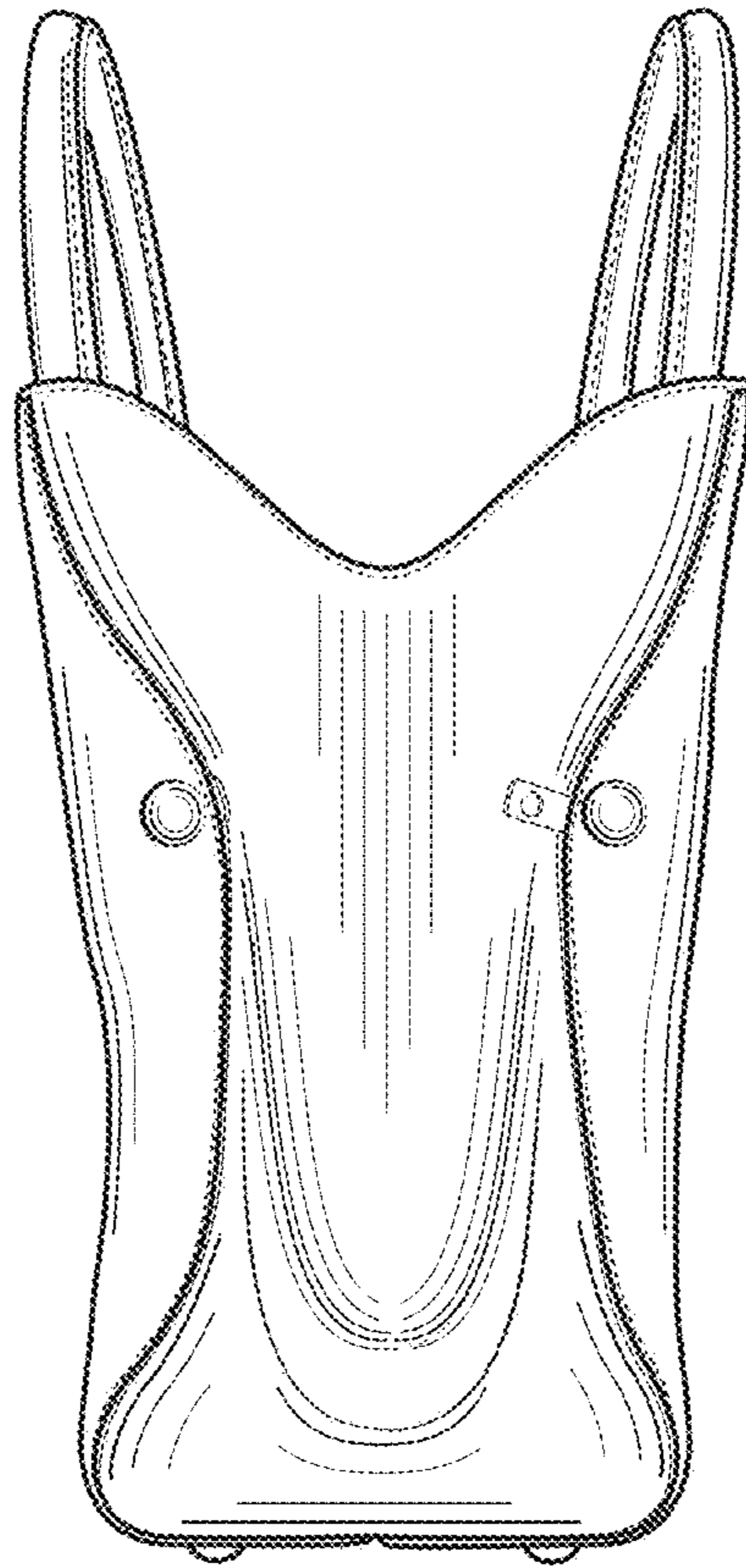

FIG. 10

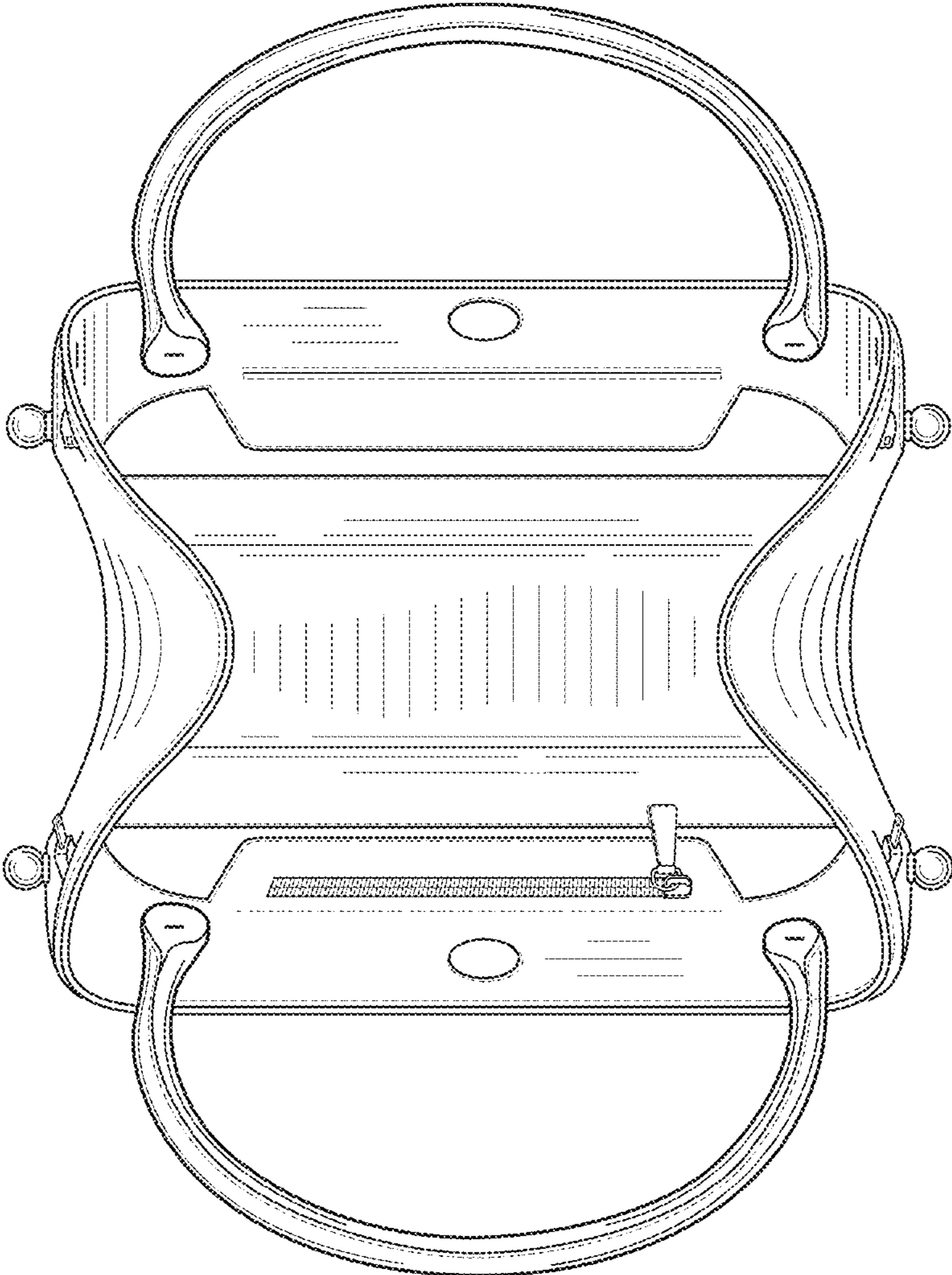

FIG. 11

