



US00D711045S

(12) **United States Design Patent**  
**Palmer et al.**

(10) **Patent No.:** **US D711,045 S**  
(45) **Date of Patent:** **\*\* Aug. 12, 2014**

- (54) **CLIPPER HEAD**
- (71) Applicants: **Bradley Palmer**, Chicago, IL (US);  
**Chenglin Zheng**, Henan Province (CN)
- (72) Inventors: **Bradley Palmer**, Chicago, IL (US);  
**Chenglin Zheng**, Henan Province (CN)
- (73) Assignee: **Medline Industries, Inc.**, Mundelein, IL (US)

D567,446 S	4/2008	Hara et al.	
D583,098 S *	12/2008	Giannini .....	D28/54
D602,636 S *	10/2009	Lothar et al. ....	D28/54
D624,244 S *	9/2010	Giannini .....	D28/54
D628,743 S *	12/2010	Shoavi .....	D28/52
2003/0145469 A1 *	8/2003	Ogawa et al. ....	30/210

(\*\*) Term: **14 Years**  
(21) Appl. No.: **29/446,526**

FOREIGN PATENT DOCUMENTS

EP 1932633 B1 3/2010  
\* cited by examiner

- (22) Filed: **Feb. 25, 2013**
- (51) **LOC (10) Cl.** ..... **28-03**
- (52) **U.S. Cl.**  
USPC ..... **D28/54**
- (58) **Field of Classification Search**  
USPC ..... D28/44-54, 44-48; 30/34.05, 32, 34.1,  
30/34.2, 43-43.92, 526-527, 44-45, 341,  
30/226-227, 231, 233-233.5  
See application file for complete search history.

*Primary Examiner* — Jennifer Rivard  
(74) *Attorney, Agent, or Firm* — McAndrews Held & Malloy, Ltd.

(57) **CLAIM**  
The ornamental design for a clipper head, as shown and described.

(56) **References Cited**

**DESCRIPTION**

U.S. PATENT DOCUMENTS

D342,345 S	12/1993	Yonezawa	
D451,639 S *	12/2001	Lior .....	D28/44
D566,898 S	4/2008	Hara	
D567,444 S *	4/2008	Giannini .....	D28/54
D567,445 S *	4/2008	Giannini .....	D28/54

FIG. 1 is a front perspective view of a clipper head showing our new design;  
FIG. 2 is a rear perspective view thereof;  
FIG. 3 is a rear elevation view thereof;  
FIG. 4 is a front elevation view thereof;  
FIG. 5 is a left side elevation view thereof;  
FIG. 6 is a right side elevation view thereof;  
FIG. 7 is a top plan view thereof; and,  
FIG. 8 is a bottom plan view thereof.  
The dot dash lines in the figures represent an unclaimed boundary line and form no part of the claimed design.

**1 Claim, 1 Drawing Sheet**

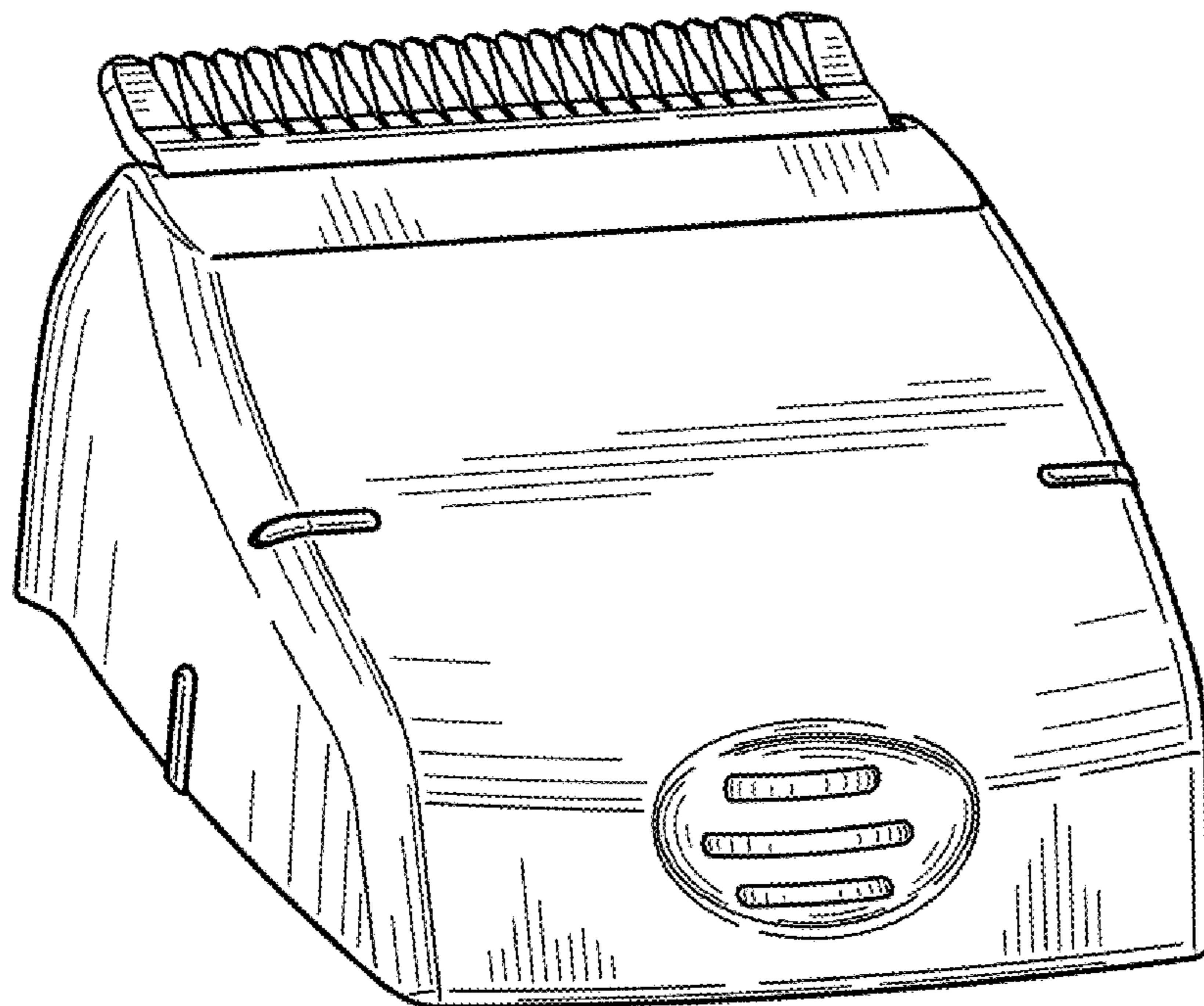

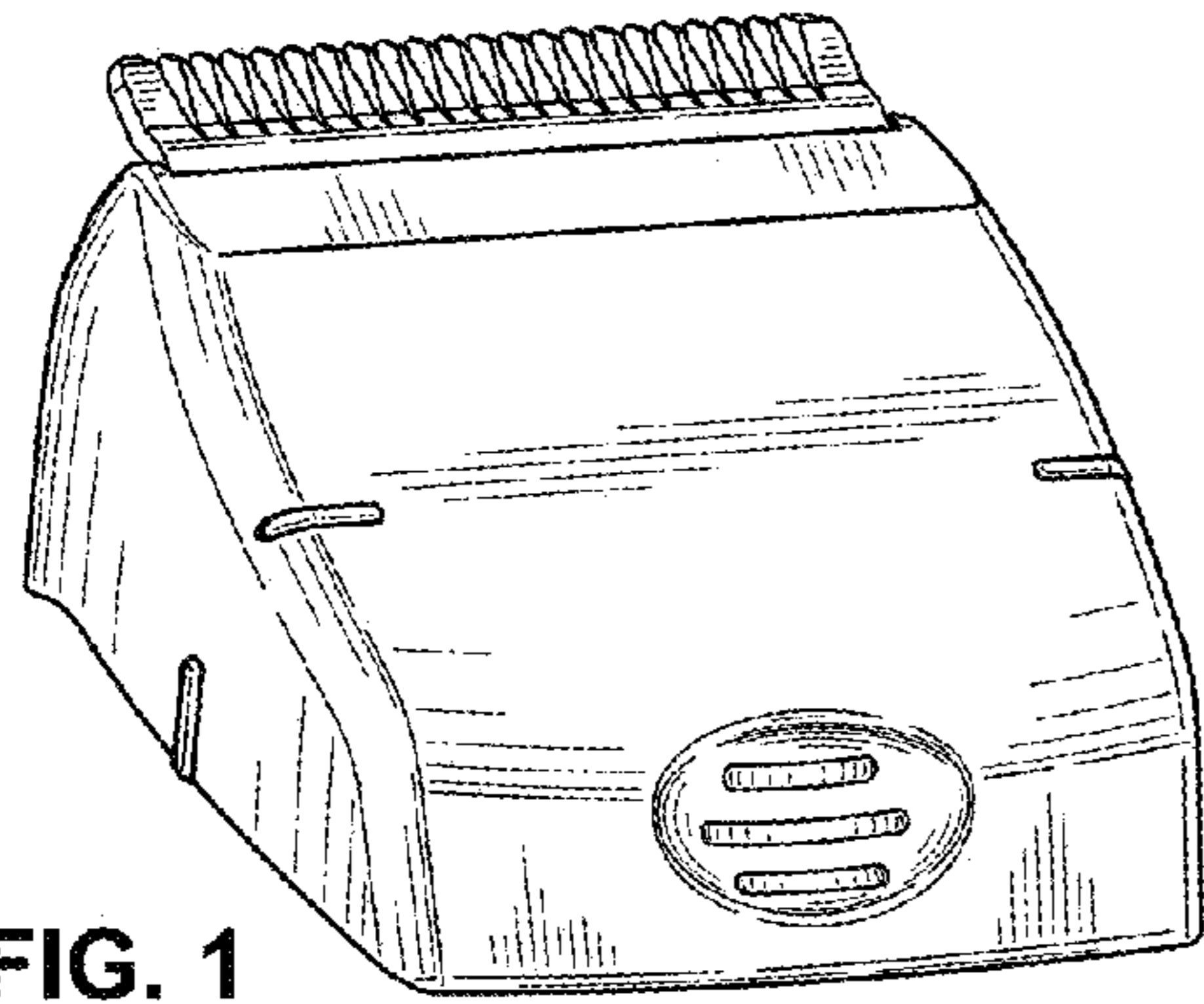

FIG. 1

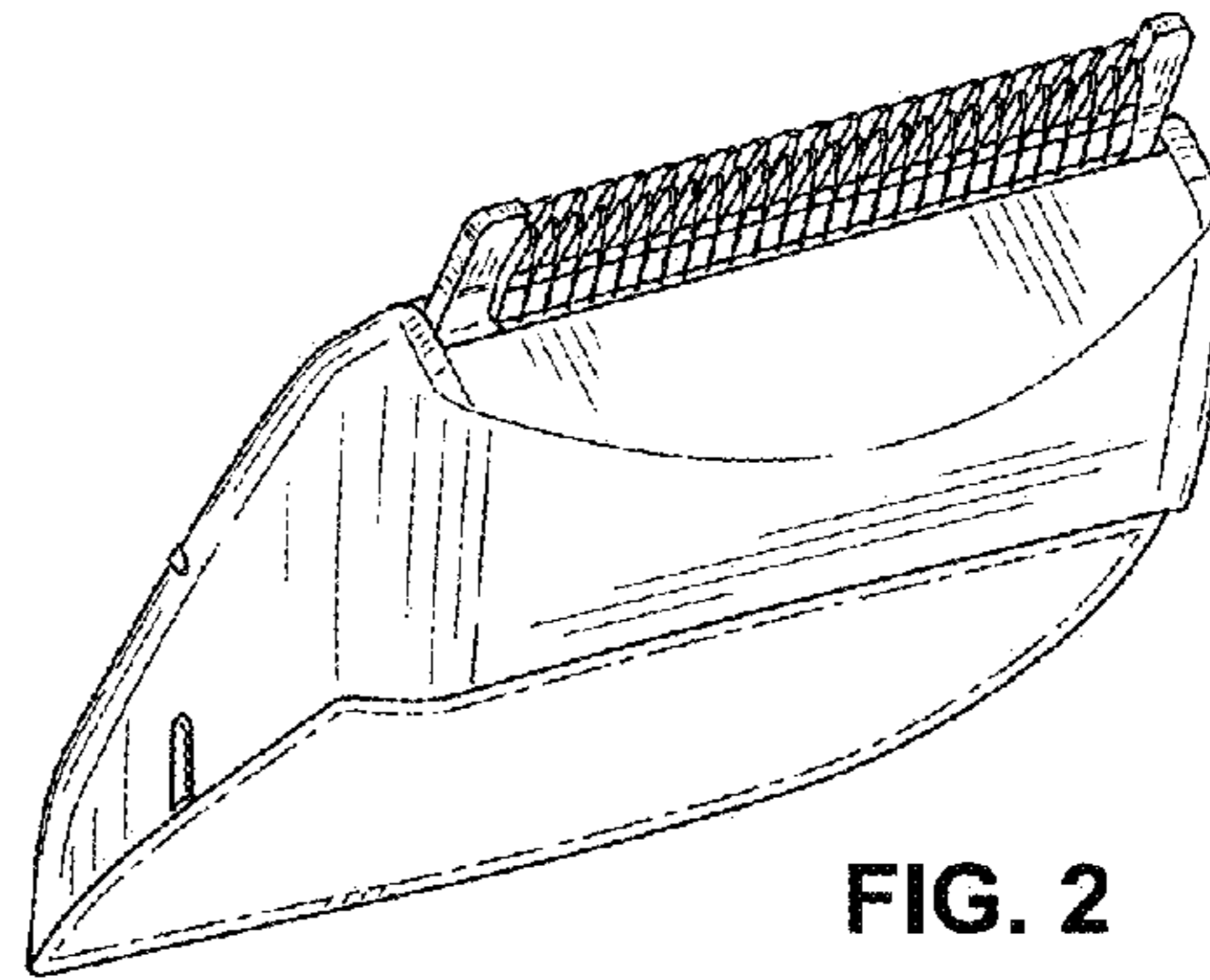

FIG. 2

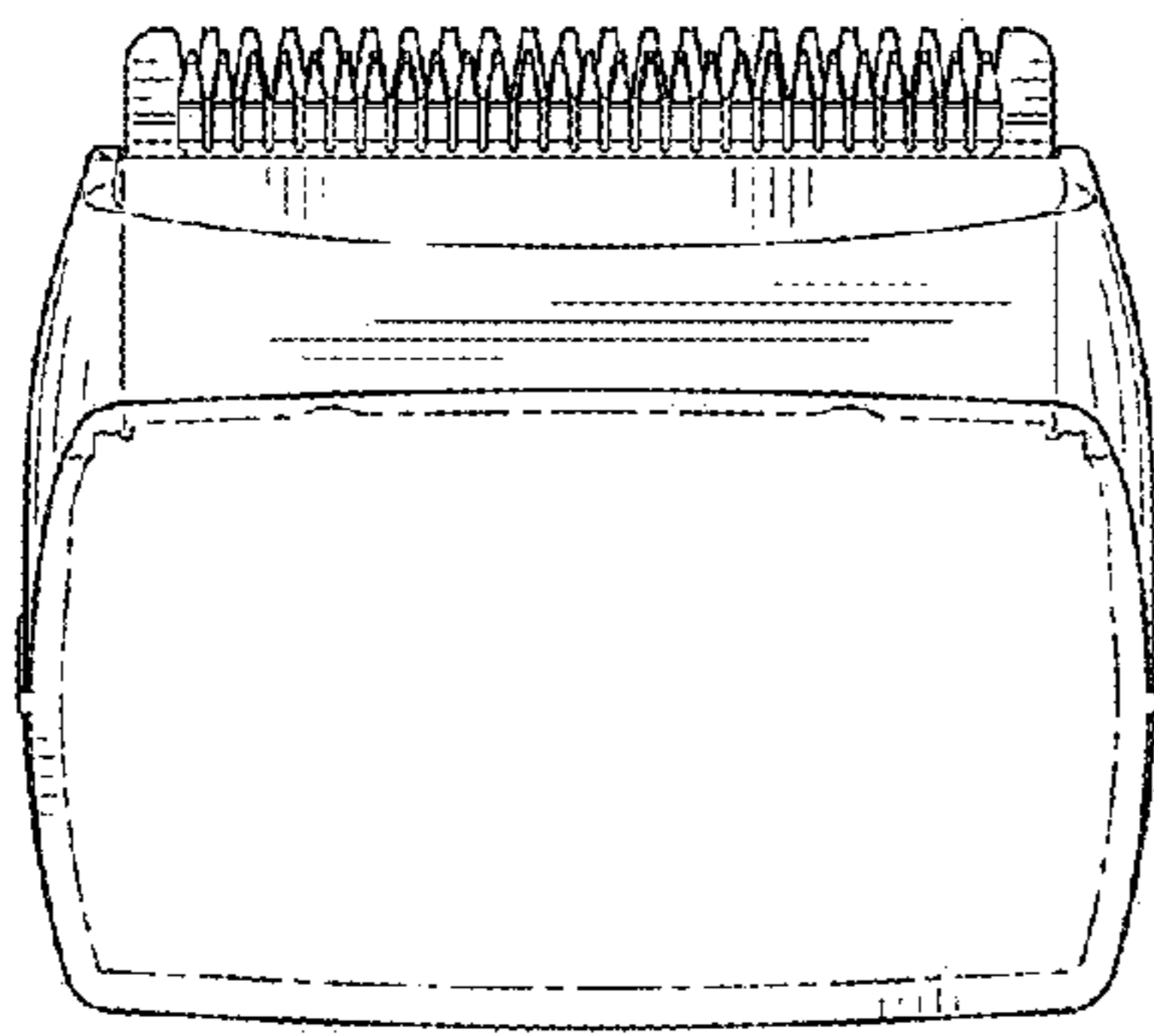

FIG. 3

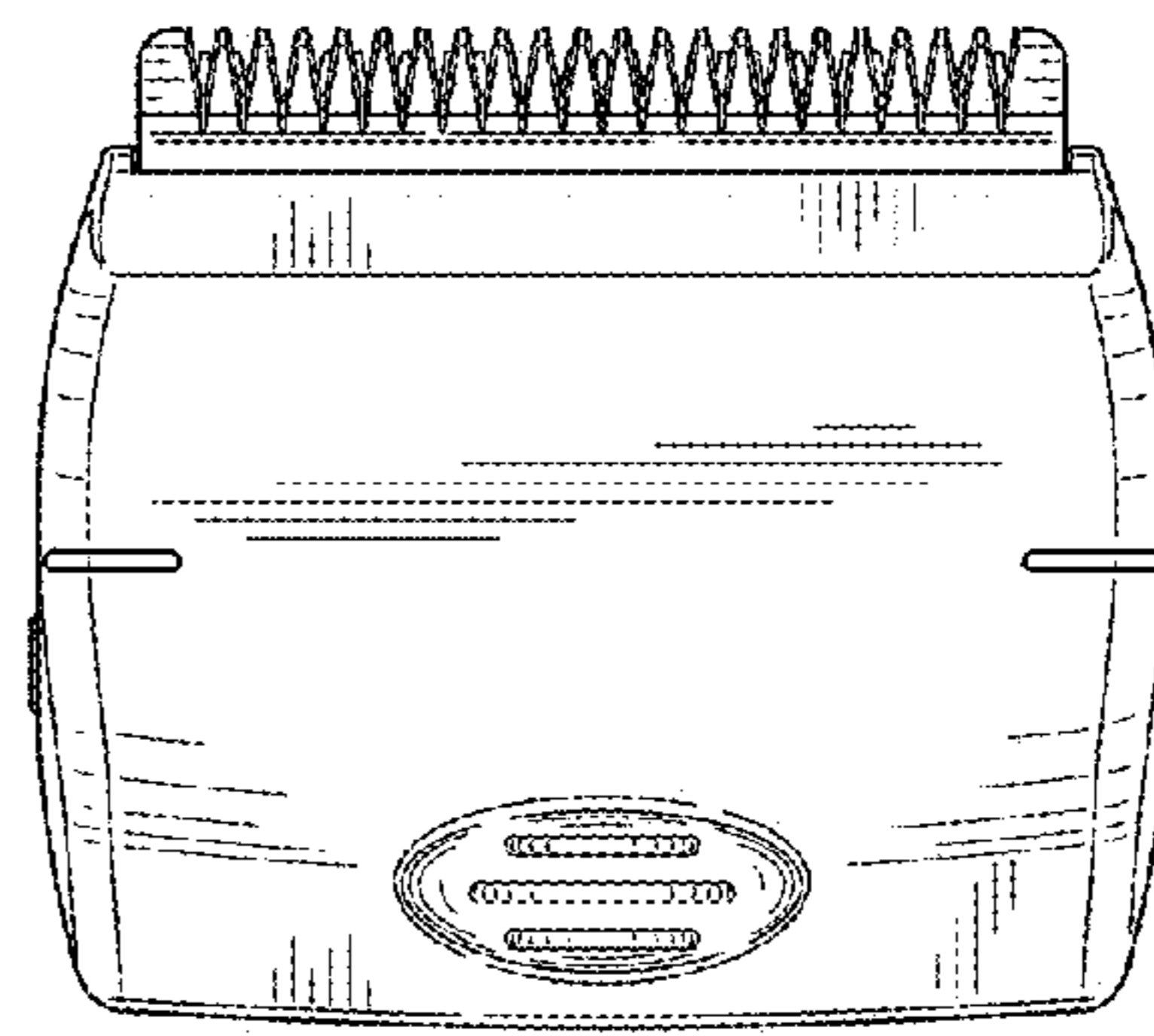

FIG. 4

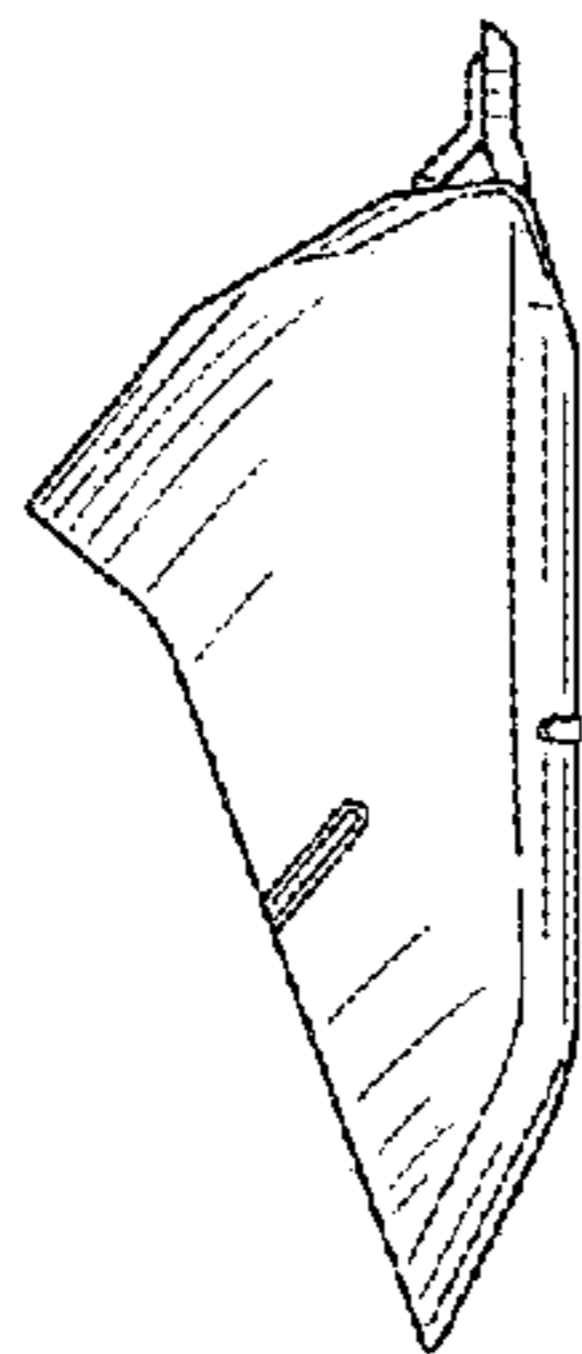

FIG. 5

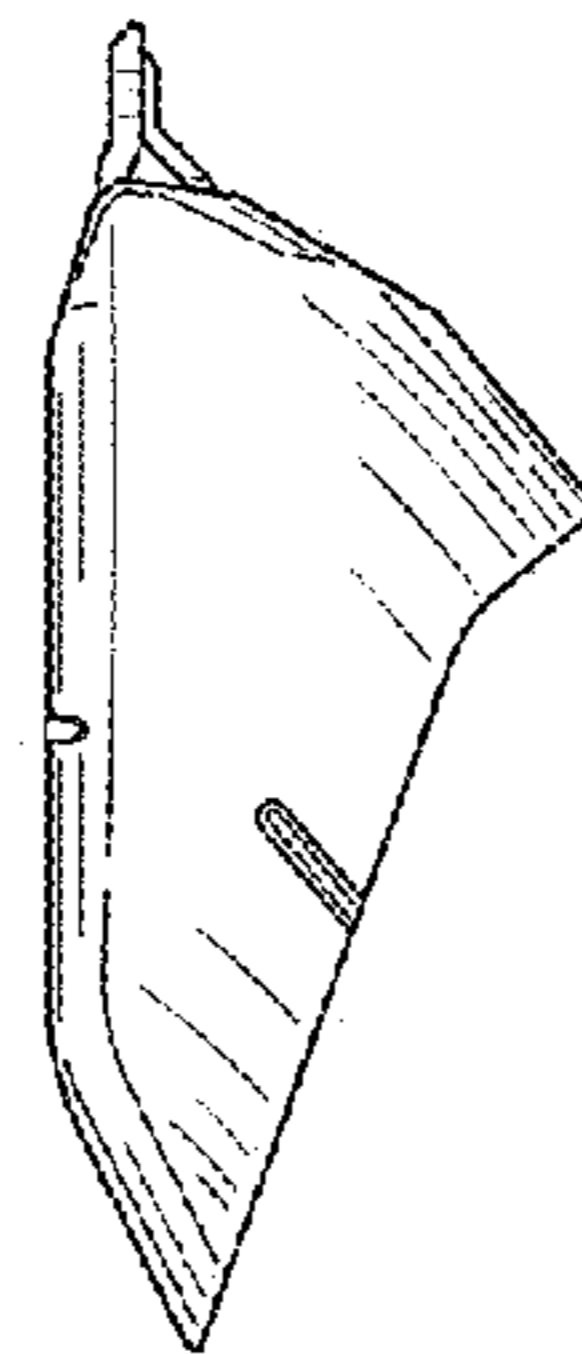

FIG. 6

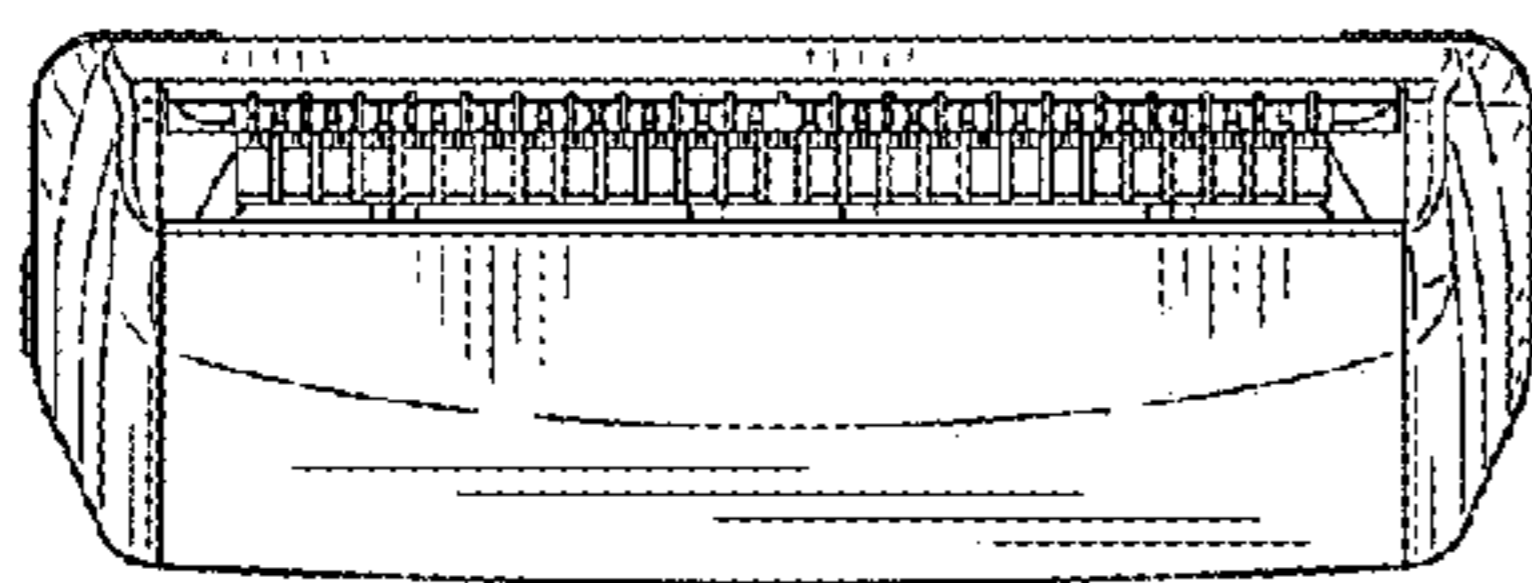

FIG. 7

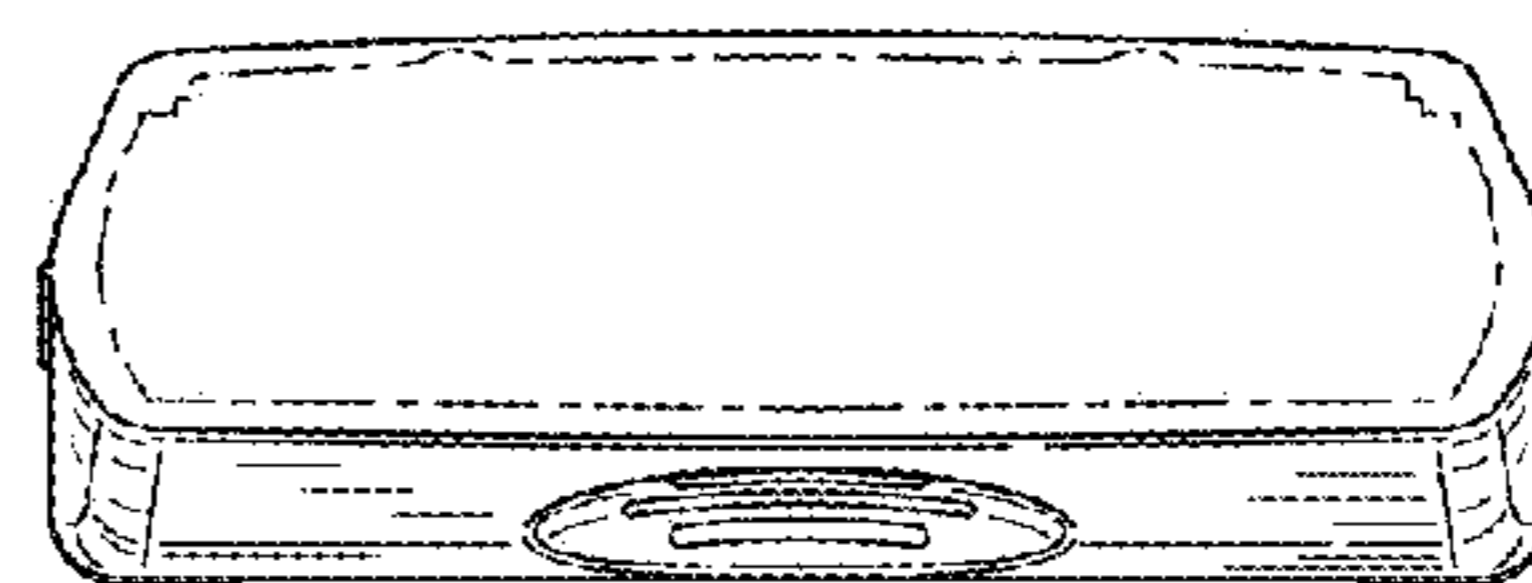

FIG. 8