



US00D711031S

(12) **United States Design Patent**  
**Moghal et al.**

(10) **Patent No.:** **US D711,031 S**

(45) **Date of Patent:** **\*\* Aug. 12, 2014**

(54) **STREET LIGHT**

(71) Applicants: **Khurram Zeshan Moghal**, Senoia, GA (US); **Christopher Michael Bryant**, Social Circle, GA (US)

(72) Inventors: **Khurram Zeshan Moghal**, Senoia, GA (US); **Christopher Michael Bryant**, Social Circle, GA (US)

(73) Assignee: **Cooper Technologies Company**, Houston, TX (US)

(\*\*) Term: **14 Years**

(21) Appl. No.: **29/457,712**

(22) Filed: **Jun. 12, 2013**

(51) **LOC (10) Cl.** ..... **26-05**

(52) **U.S. Cl.**  
USPC ..... **D26/71; D26/107**

(58) **Field of Classification Search**  
CPC ..... F21S 8/085; F21S 8/086; F21S 8/088;  
F21V 21/14  
USPC ..... D26/67-71, 92, 107; 362/249.01,  
362/249.02, 235-237, 157, 183, 431, 432  
See application file for complete search history.

(56) **References Cited**

**U.S. PATENT DOCUMENTS**

D63,356 S *	11/1923	Bowen	.....	D26/107
D142,407 S *	9/1945	Greppin	.....	D26/64
D167,681 S *	9/1952	Farrington et al.	.....	D26/143
2,653,782 A *	9/1953	Pfaff, Jr.	.....	248/219.1
D177,916 S *	6/1956	Keck et al.	.....	D26/145
2,750,142 A *	6/1956	McKee	.....	248/222.14
2,907,543 A *	10/1959	Heinzen	.....	248/219.1

2,966,324 A *	12/1960	Heinzen	.....	248/219.1
3,270,480 A *	9/1966	Beecker	.....	52/848
3,571,991 A *	3/1971	Doocy et al.	.....	52/40
D223,547 S *	5/1972	Ohwa	.....	D26/107
D555,280 S *	11/2007	Quintana-Creus et al.	....	D26/71
D555,281 S *	11/2007	Quintana-Creus et al.	....	D26/71
D573,298 S *	7/2008	Kinnune et al.	.....	D26/142
D574,990 S *	8/2008	Tsai	.....	D26/63
D624,689 S *	9/2010	Kao	.....	D26/102
8,061,666 B1 *	11/2011	Fortin et al.	.....	248/219.1
D650,519 S	12/2011	Maxik et al.		
D673,323 S	12/2012	Maxik et al.		
D681,874 S	5/2013	Maxik et al.		
D696,806 S *	12/2013	Duquette et al.	.....	D26/71
D696,807 S *	12/2013	Duquette et al.	.....	D26/71

\* cited by examiner

*Primary Examiner* — Clare E Heflin

(74) *Attorney, Agent, or Firm* — King & Spalding LLP

(57) **CLAIM**

The ornamental design for a street light, as shown and described.

**DESCRIPTION**

FIG. 1 is a perspective view of a street light, showing the new design;

FIG. 2 is a right-side elevation view thereof;

FIG. 3 is a left-side elevation view thereof;

FIG. 4 is a back-side elevation view thereof;

FIG. 5 is a front-side elevation view thereof;

FIG. 6 is a top plan view thereof; and,

FIG. 7 is a bottom plan view thereof.

The broken lines shown represent unclaimed subject matter and form no part of the claimed design. The dot-dash-dot lines passing through the broken lines indicate that the environment of the design is not limited to a particular height.

**1 Claim, 5 Drawing Sheets**

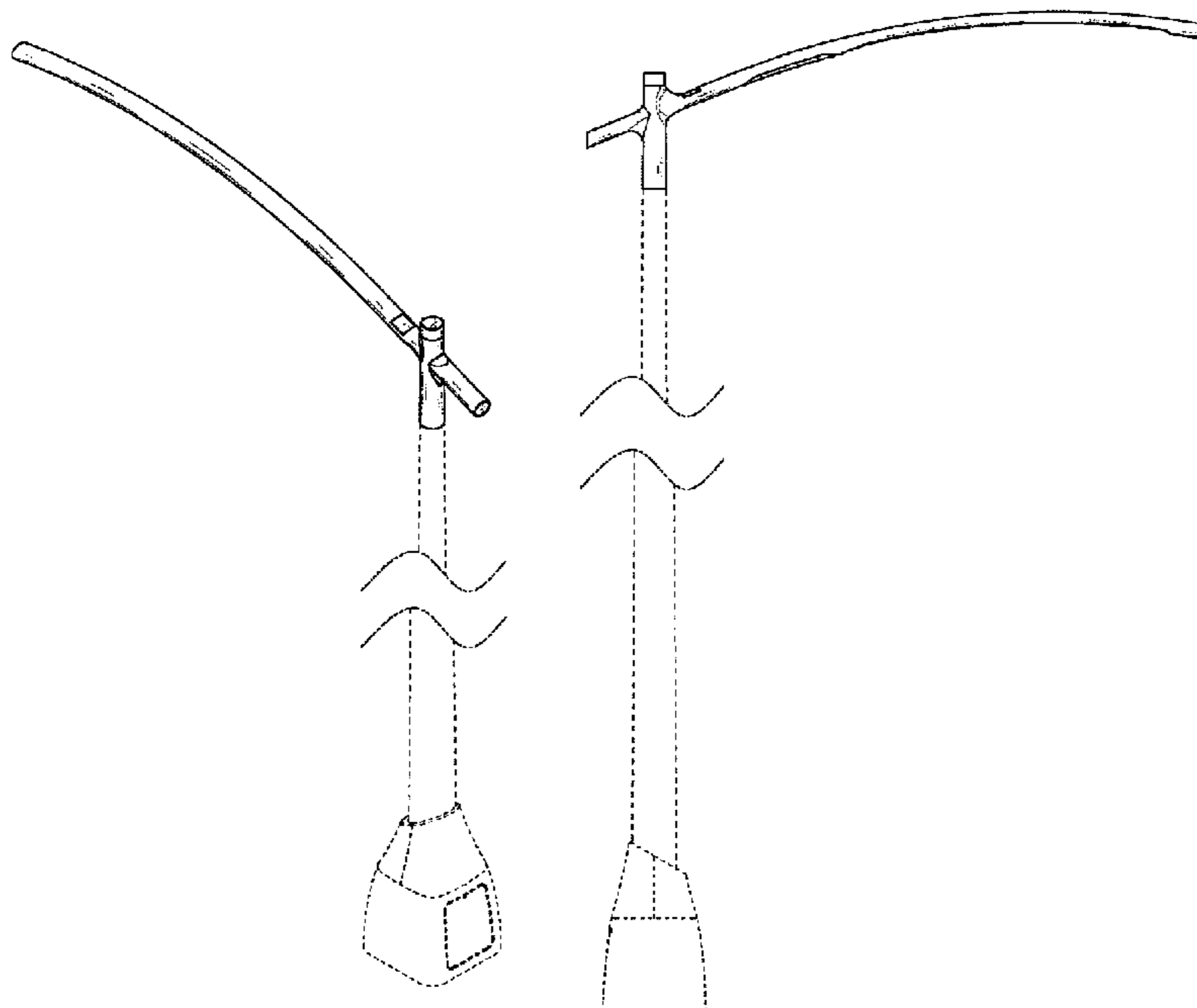

FIG. 1

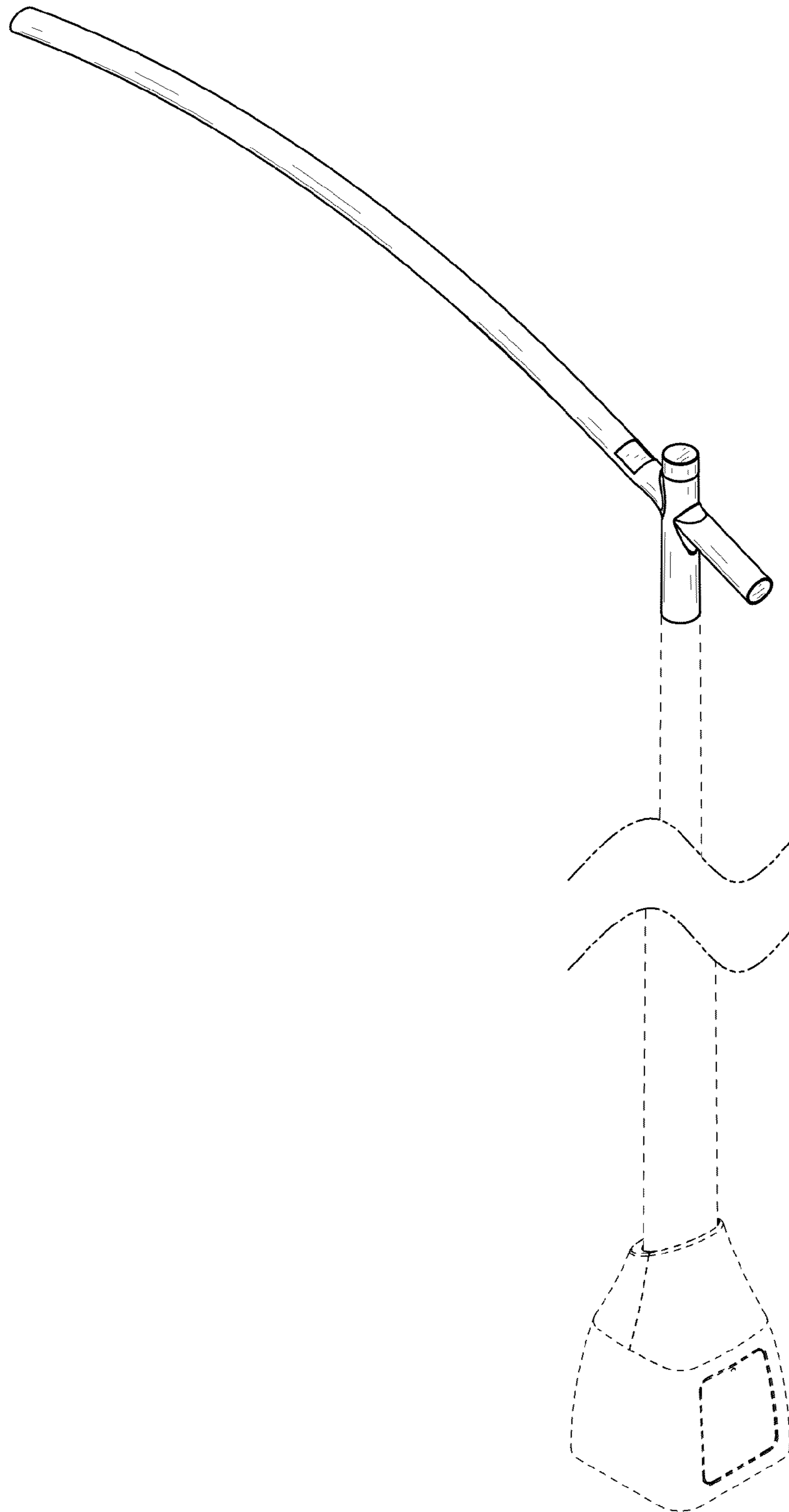

FIG. 2

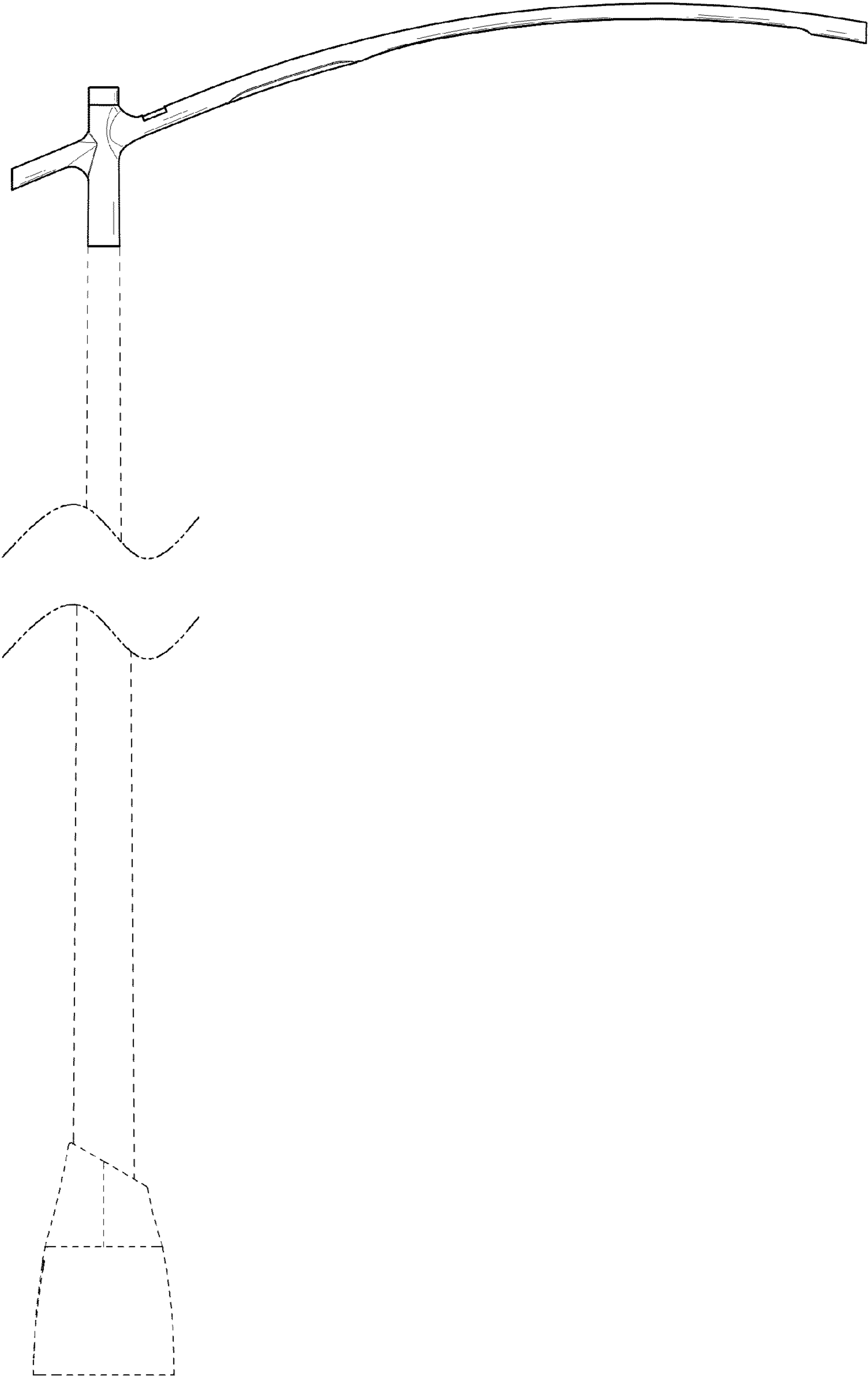

FIG. 3

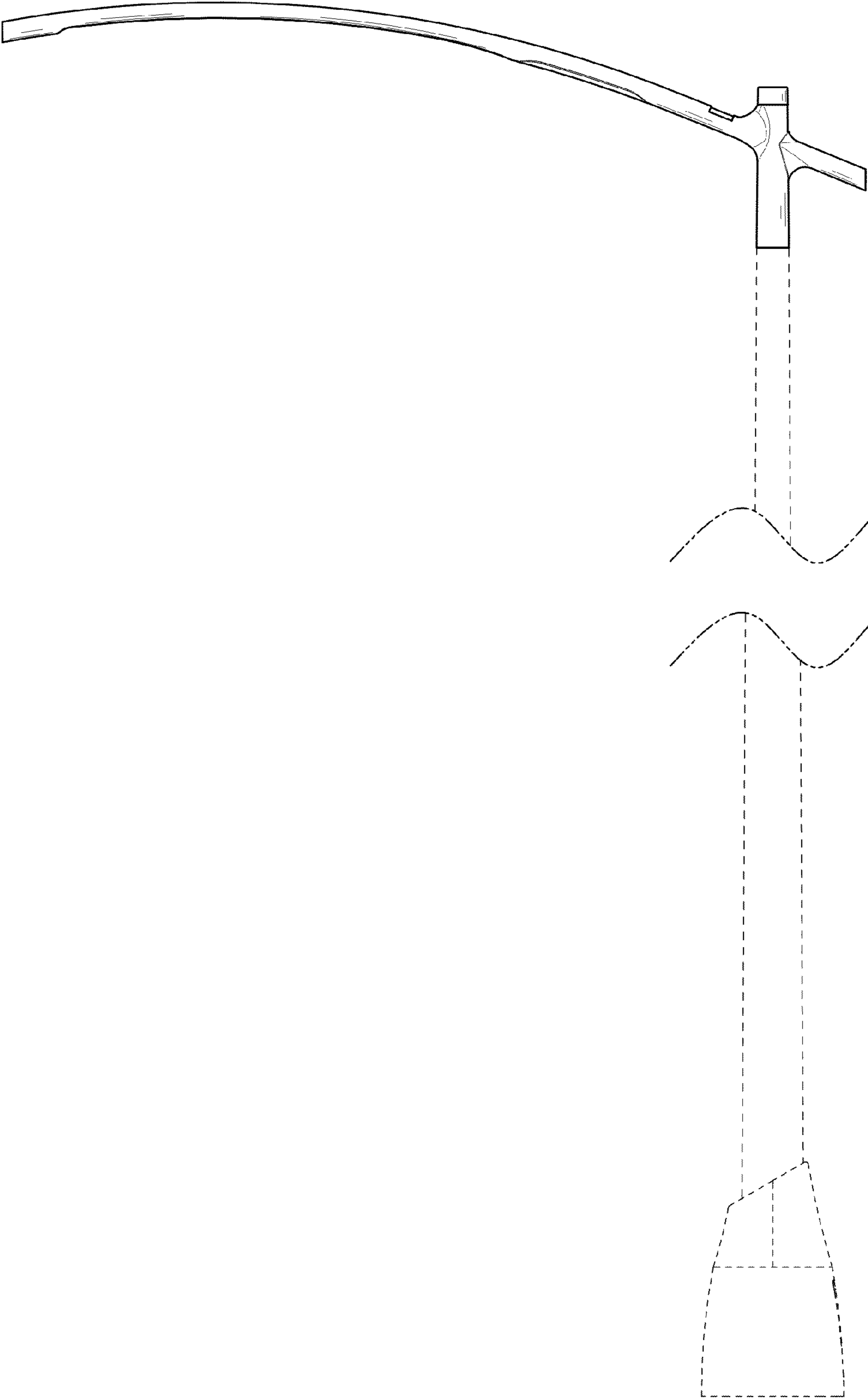

FIG. 4

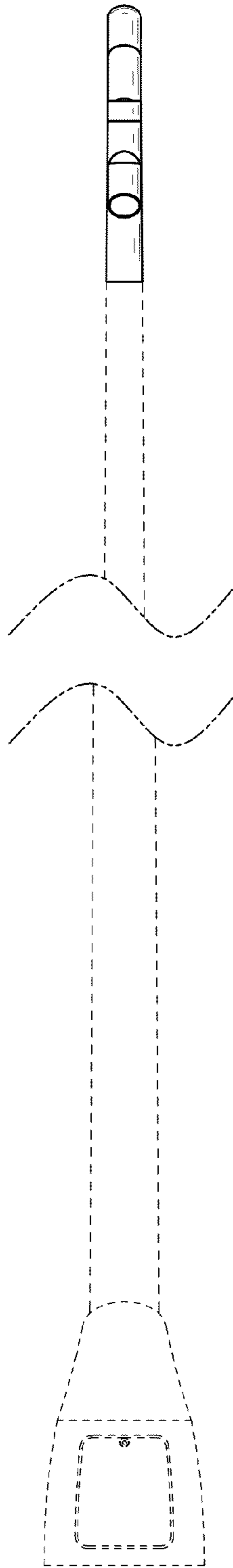

FIG. 5

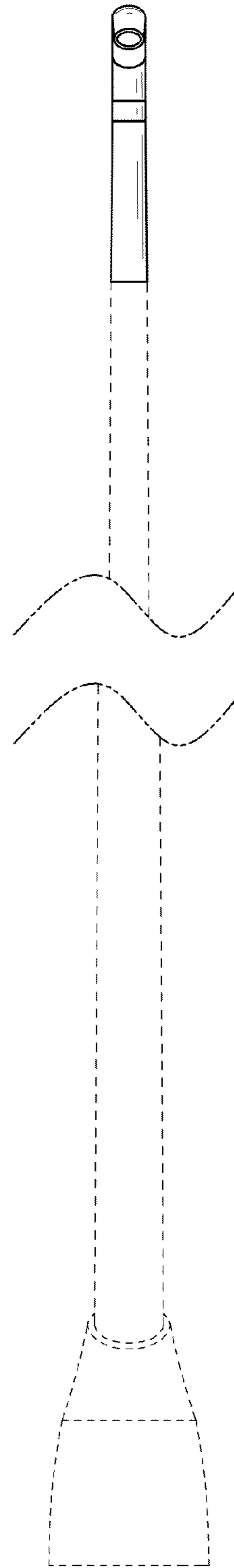

FIG. 6

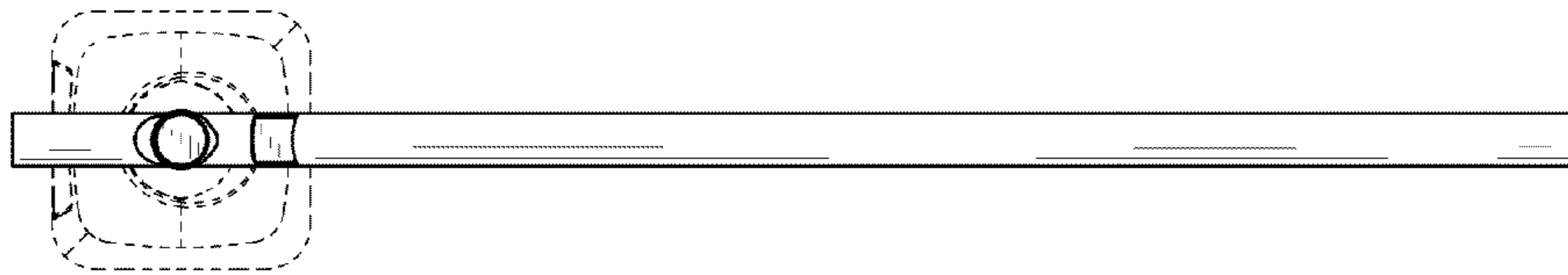

FIG. 7

