

US00D711012S

(12) **United States Design Patent**  
**Jorge**

(10) **Patent No.:** **US D711,012 S**  
(45) **Date of Patent:** **\*\* Aug. 12, 2014**

(54) **WALL ASSEMBLY**

(71) Applicant: **Manuel Jorge**, Yellowknife (CA)

(72) Inventor: **Manuel Jorge**, Yellowknife (CA)

(\*\*) Term: **14 Years**

(21) Appl. No.: **29/435,325**

(22) Filed: **Oct. 23, 2012**

(30) **Foreign Application Priority Data**

Apr. 23, 2012 (CA) ..... 145296

(51) **LOC (10) CL.** ..... **25-02**

(52) **U.S. Cl.**  
USPC ..... **D25/58**

(58) **Field of Classification Search**  
USPC ..... D25/138, 58; 52/236.1, 238.1, 239,  
52/589.1

See application file for complete search history.

(56) **References Cited**

**U.S. PATENT DOCUMENTS**

3,012,377 A \* 12/1961 Sunukjian ..... 52/286  
D336,341 S \* 6/1993 Van Steenlandt ..... D25/58  
6,467,229 B2 \* 10/2002 Azar ..... 52/589.1  
D485,368 S \* 1/2004 Hayashi ..... D25/58  
6,691,471 B2 \* 2/2004 Price ..... 52/169.12

\* cited by examiner

*Primary Examiner* — Doris Clark

(74) *Attorney, Agent, or Firm* — Davis & Bujold, PLLC;  
Michael J. Bujold

(57) **CLAIM**

The ornamental design for a wall assembly, as shown and described.

**DESCRIPTION**

FIG. 1 is a front perspective view of a flat panel of the wall assembly;

FIG. 2 is a rear perspective view of the flat panel of the wall assembly shown in FIG. 1;

FIG. 3 is a front elevation view of the flat panel of the wall assembly shown in FIG. 1;

FIG. 4 is a rear elevation view of the flat panel of the wall assembly shown in FIG. 1;

FIG. 5 is a top plan view of the flat panel of the wall assembly shown in FIG. 1;

FIG. 6 is a left side elevation view of the flat panel of the wall assembly shown in FIG. 1;

FIG. 7 is a right side elevation view of the flat panel of the wall assembly shown in FIG. 1;

FIG. 8 is a front perspective view of an outside corner panel of the wall assembly;

FIG. 9 is a rear perspective view of the outside corner panel of the wall assembly shown in FIG. 8;

FIG. 10 is a front elevation view of the outside corner panel of the wall assembly shown in FIG. 8;

FIG. 11 is a rear elevation view of the outside corner panel of the wall assembly shown in FIG. 8;

FIG. 12 is a top plan view of the outside corner panel of the wall assembly shown in FIG. 8;

FIG. 13 is a left side elevation view of the outside corner panel of the wall assembly shown in FIG. 8;

FIG. 14 is a right side elevation view of the outside corner panel of the wall assembly shown in FIG. 8;

FIG. 15 is a front perspective view of an inside corner panel of the wall assembly;

FIG. 16 is a rear perspective view of the inside corner panel of the wall assembly shown in FIG. 15;

FIG. 17 is a front elevation view of the inside corner panel of the wall assembly shown in FIG. 15;

FIG. 18 is a rear elevation view of the inside corner panel of the wall assembly shown in FIG. 15;

FIG. 19 is a top plan view of the inside corner panel of the wall assembly shown in FIG. 15;

FIG. 20 is a left side elevation view of the inside corner panel of the wall assembly shown in FIG. 15; and

FIG. 21 is a right side elevation view of the inside corner panel of the wall assembly shown in FIG. 15.

FIG. 22 is a front perspective view of the wall assembly; and, FIG. 23 is a rear perspective view of the wall assembly.

**1 Claim, 8 Drawing Sheets**

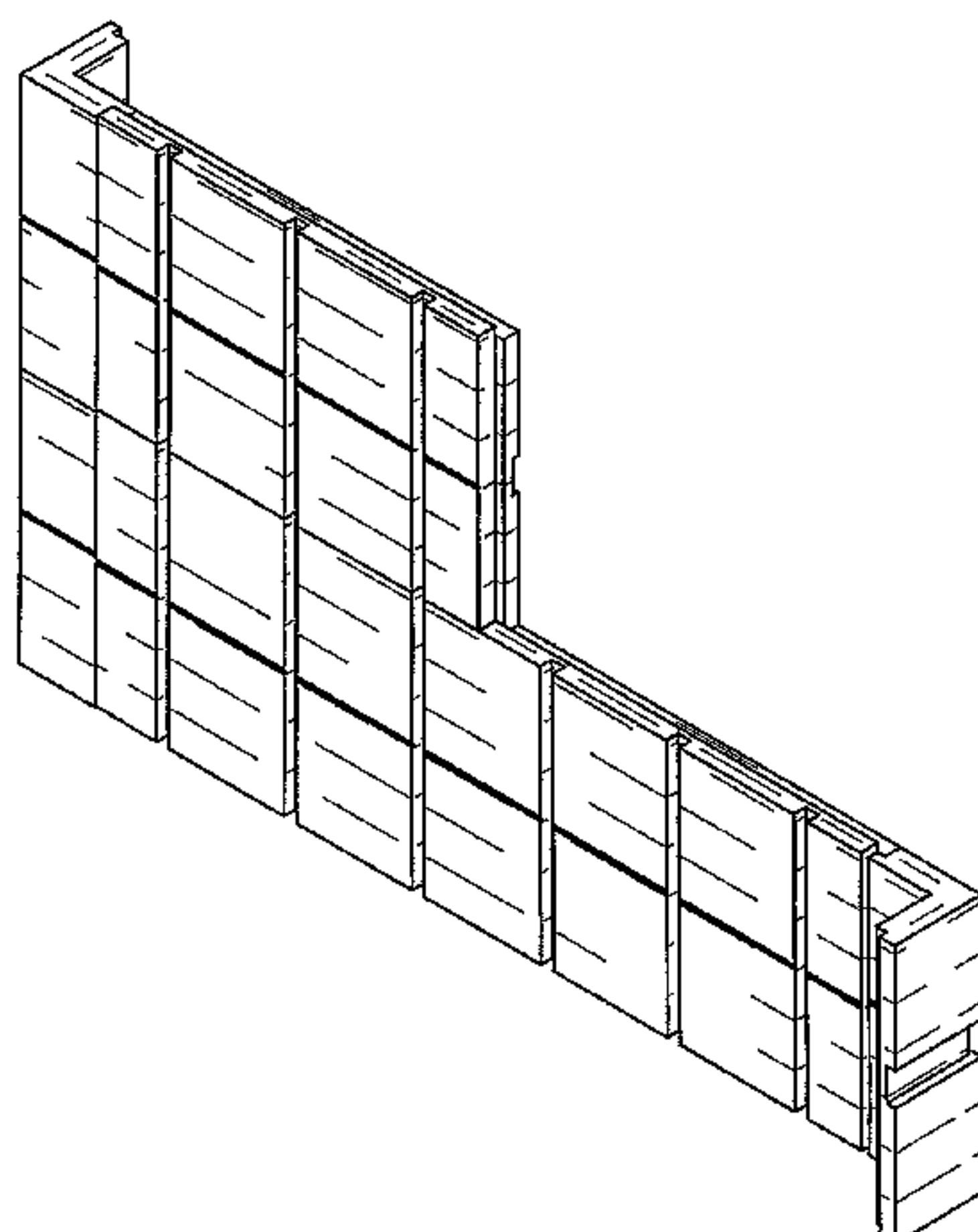

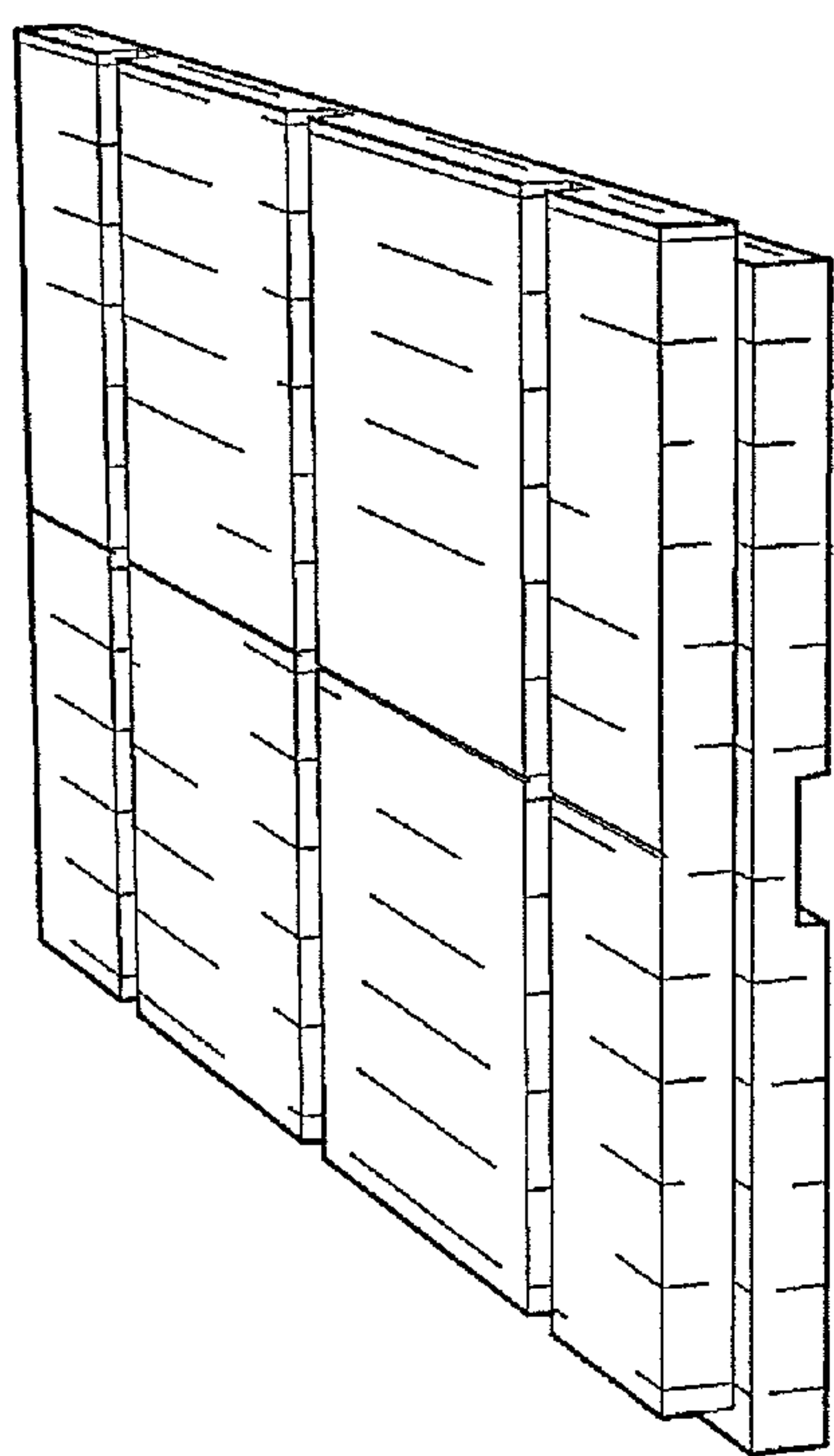

FIG. 1

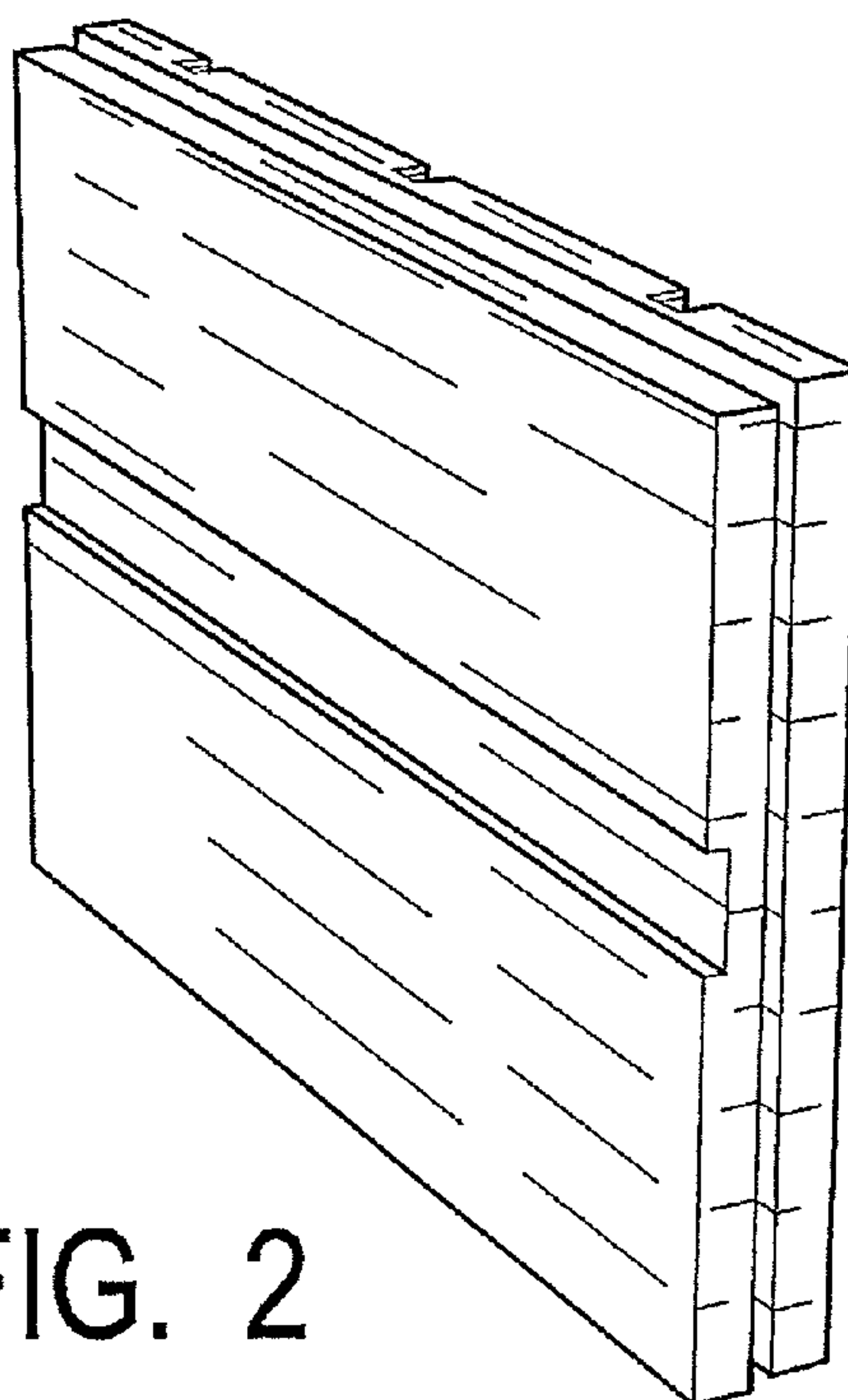

FIG. 2

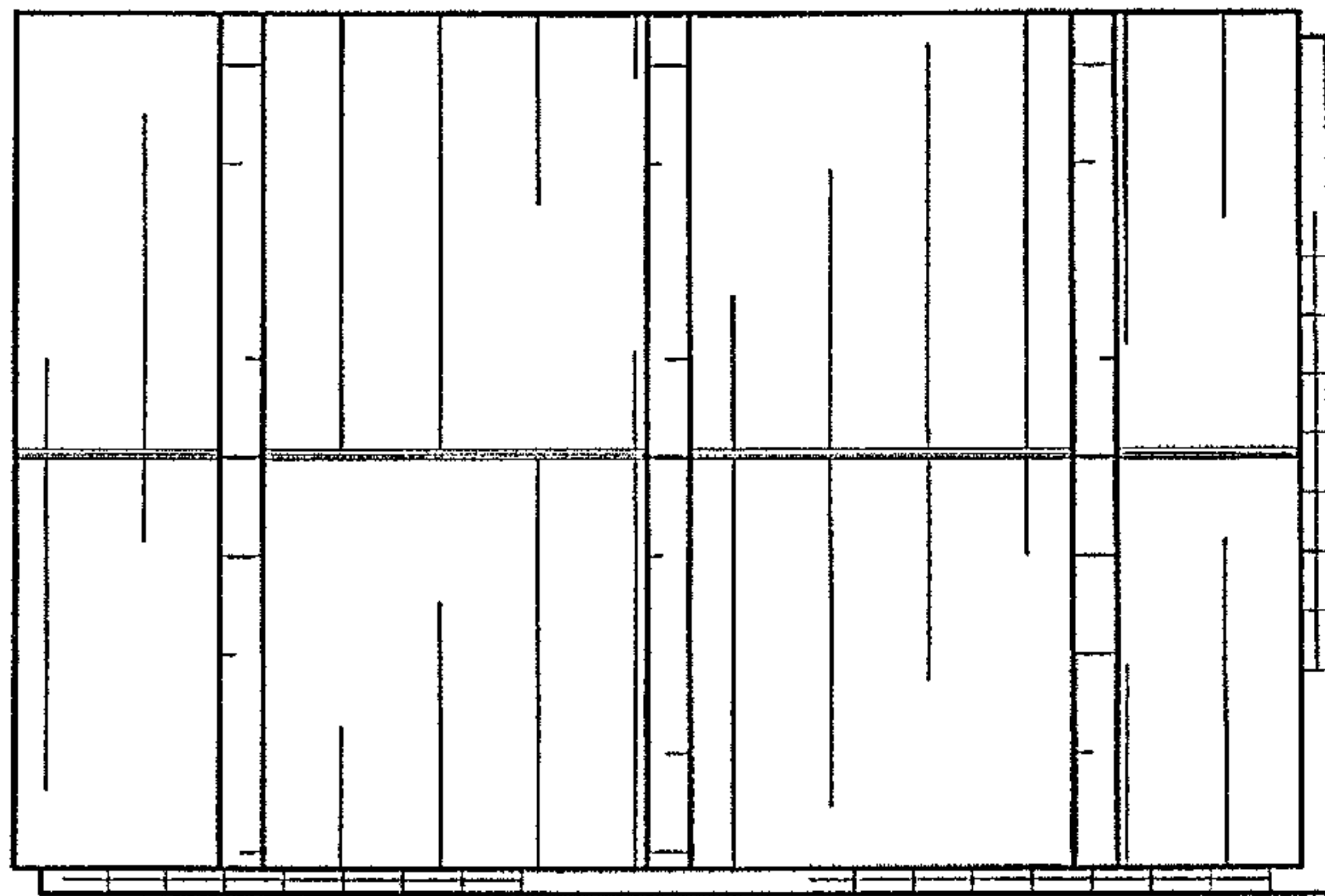

FIG. 3

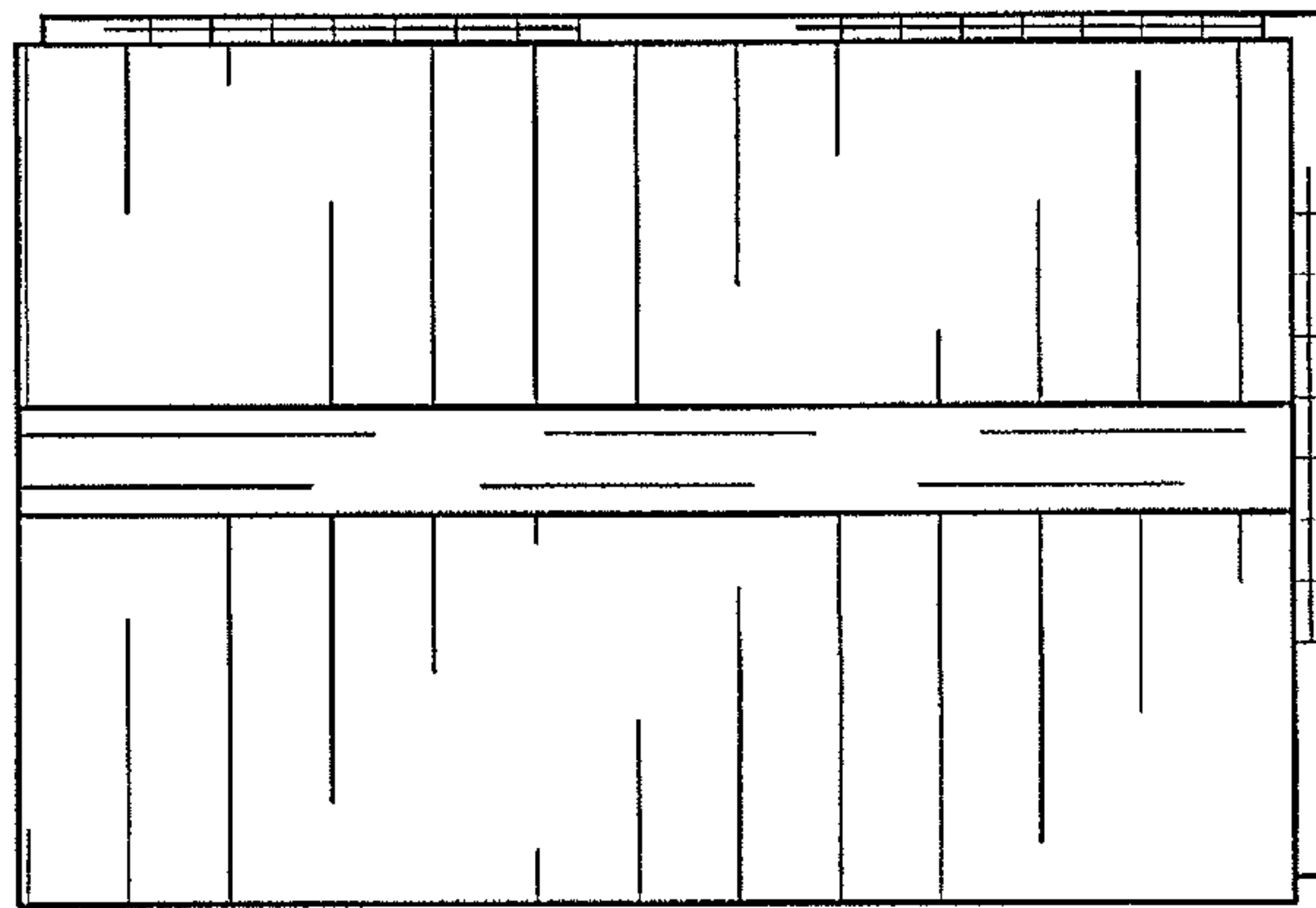

FIG. 4



FIG. 5



FIG. 6



FIG. 7

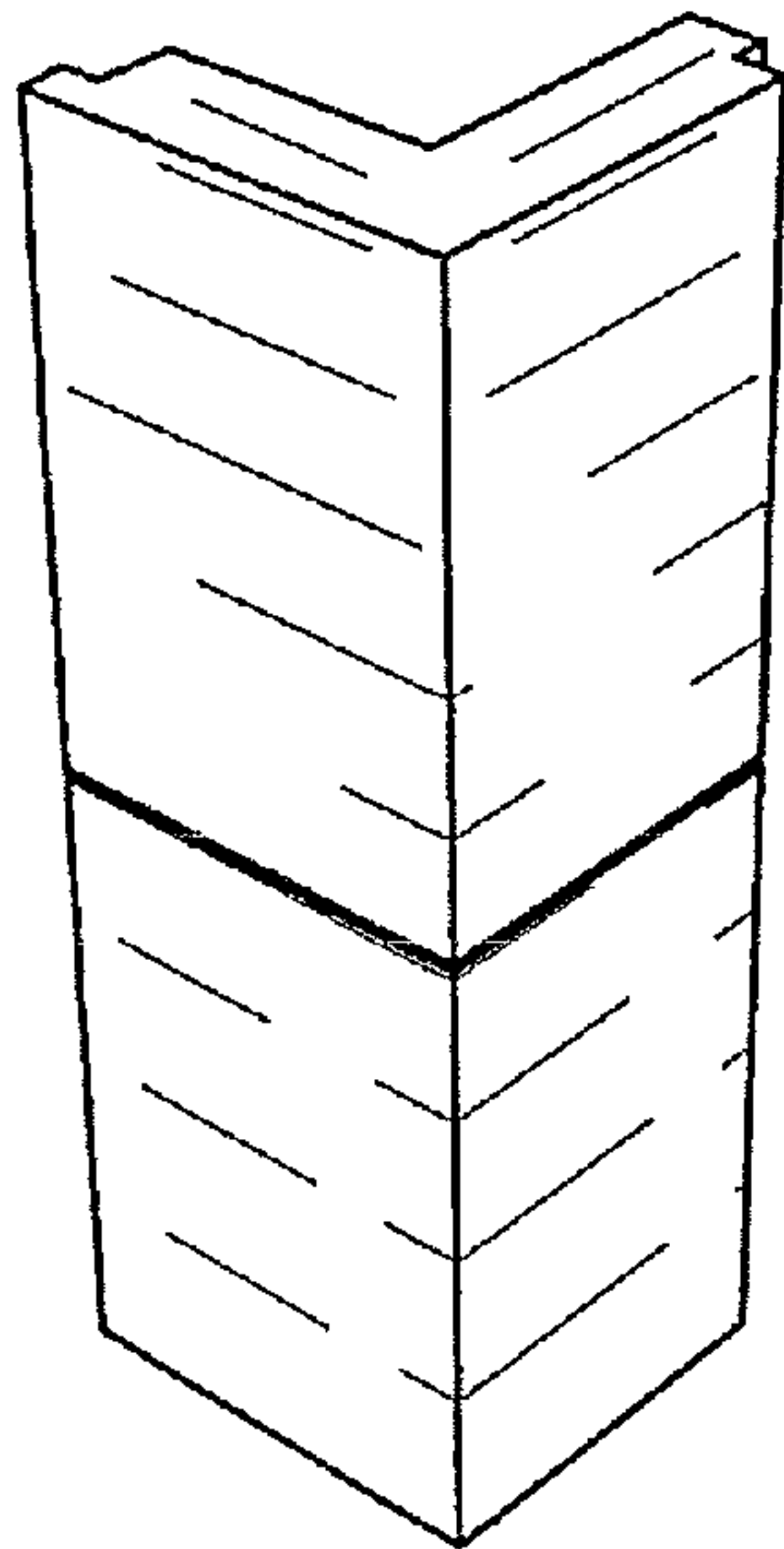

FIG. 8

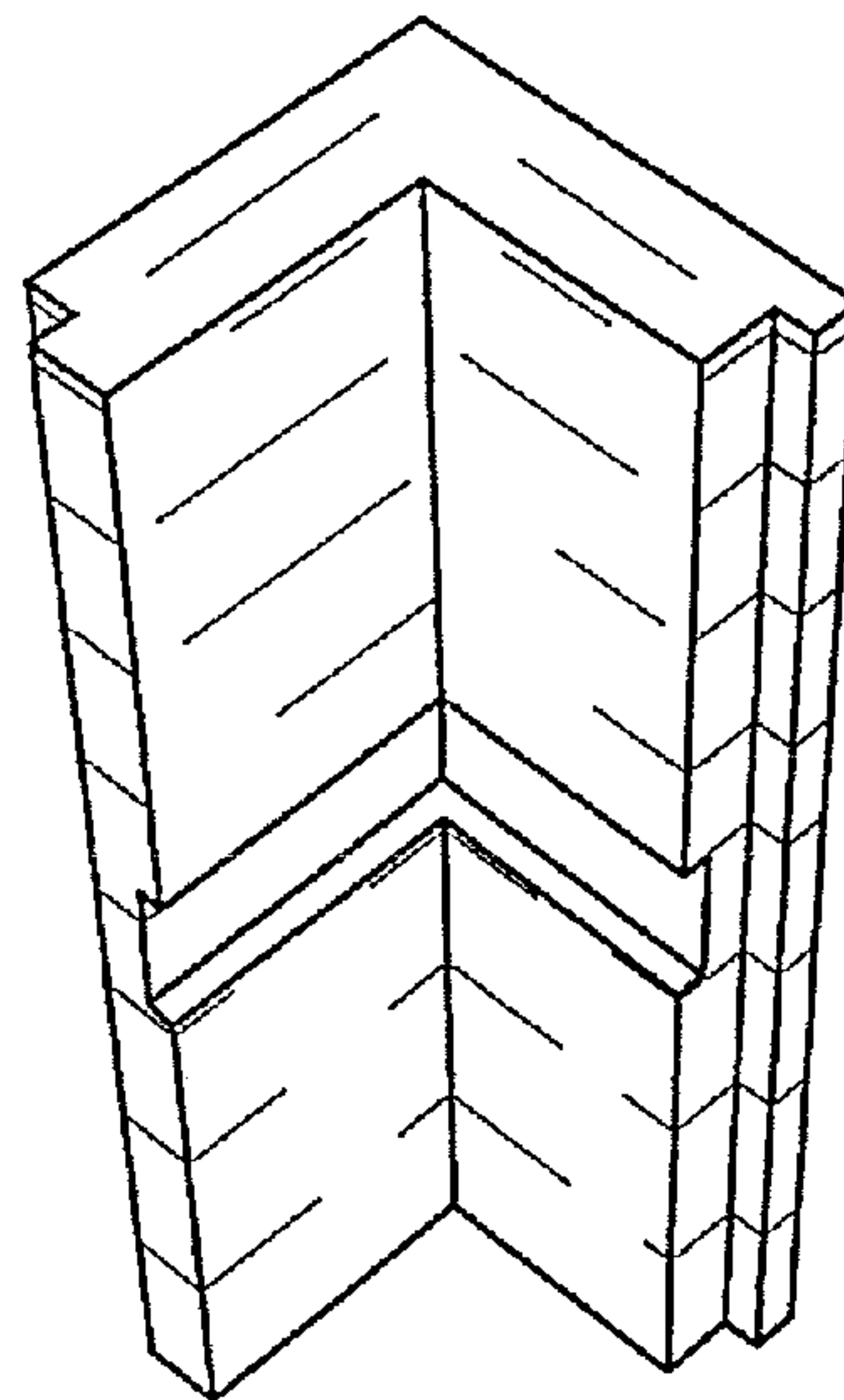

FIG. 9

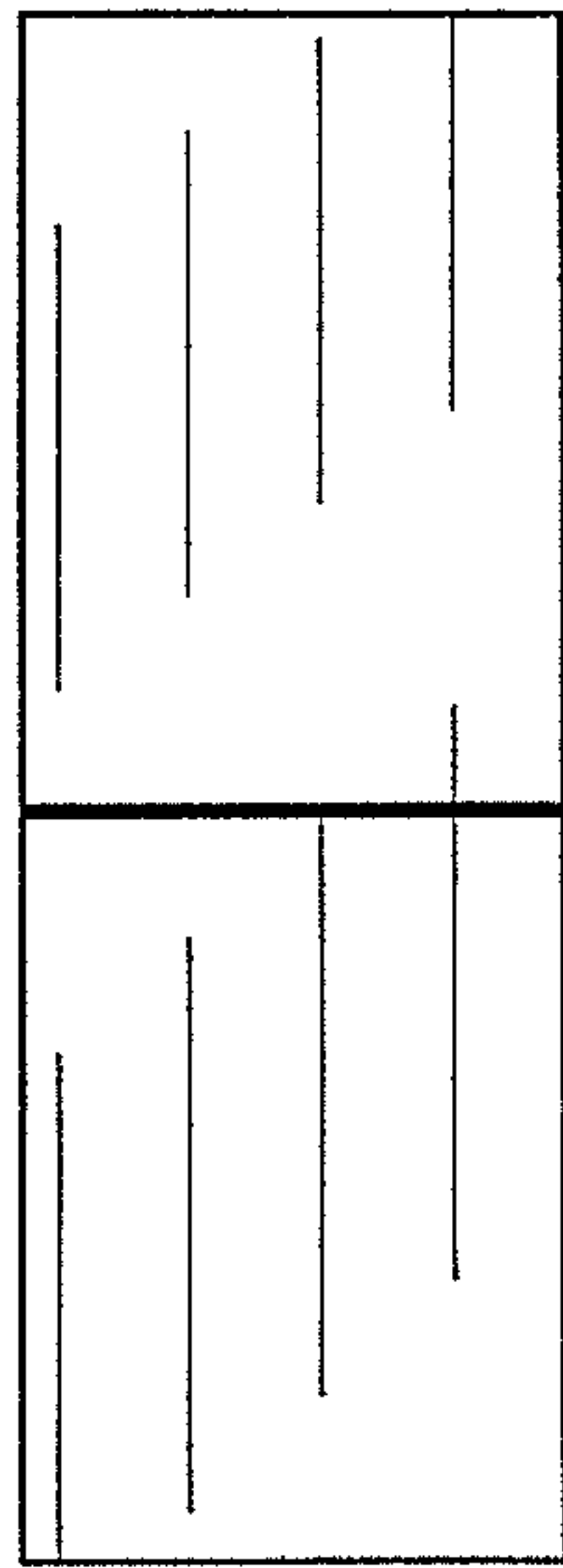

FIG. 10

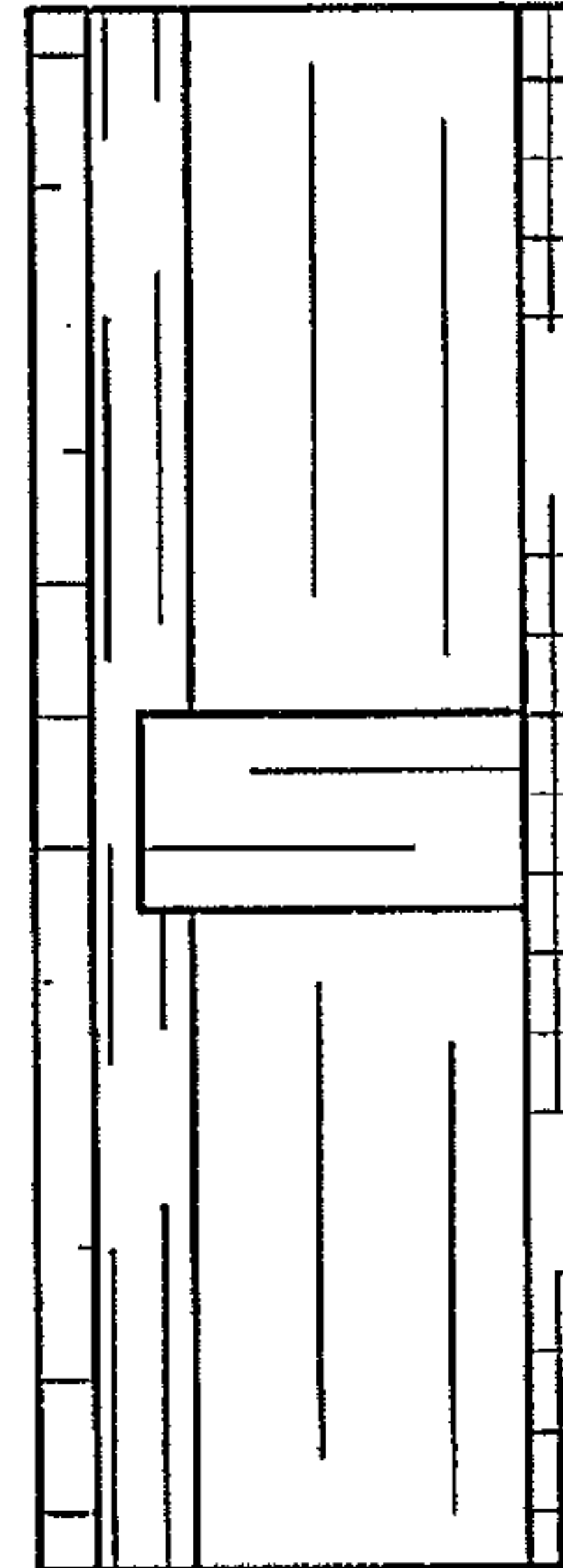

FIG. 11

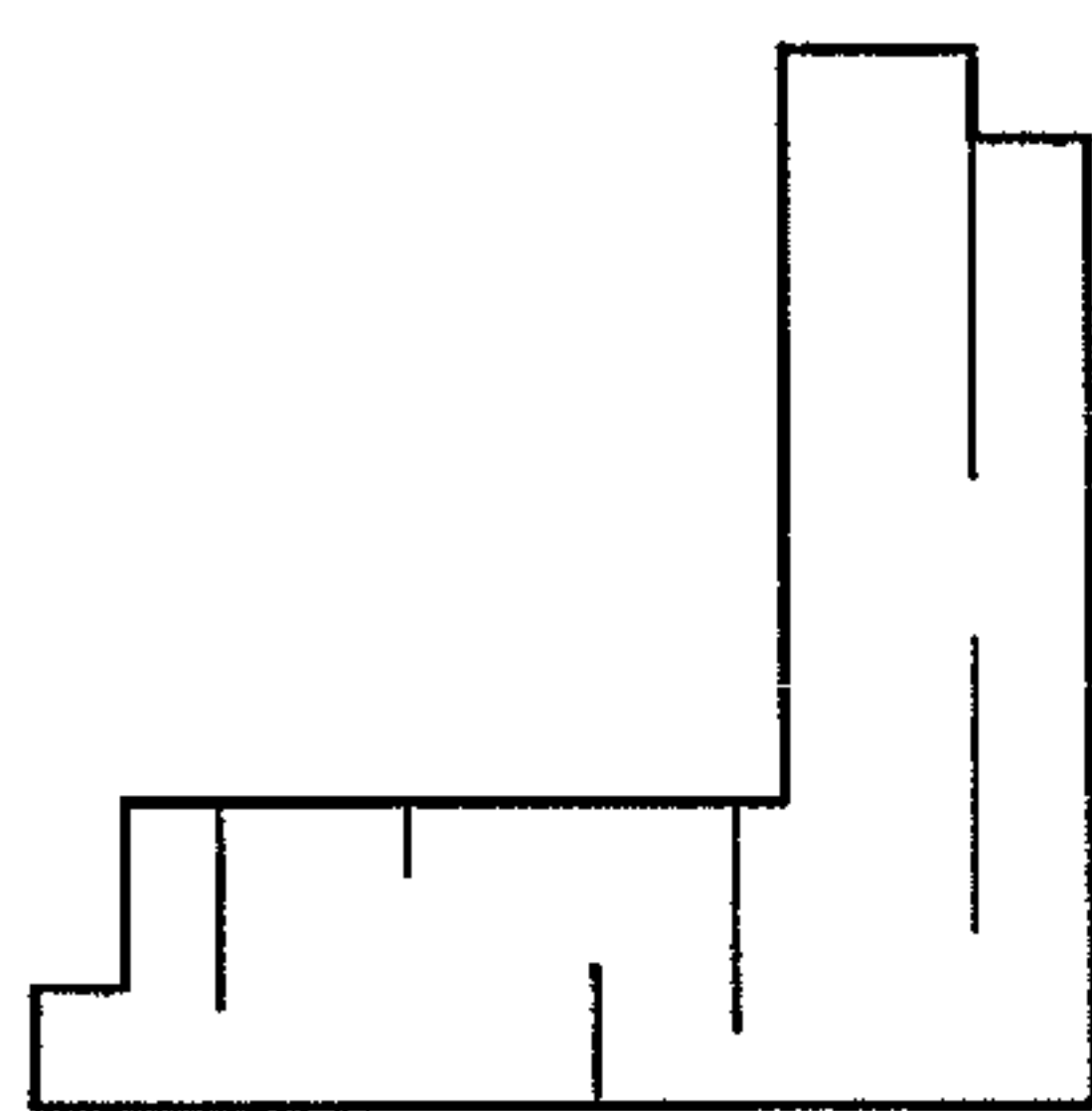

FIG. 12

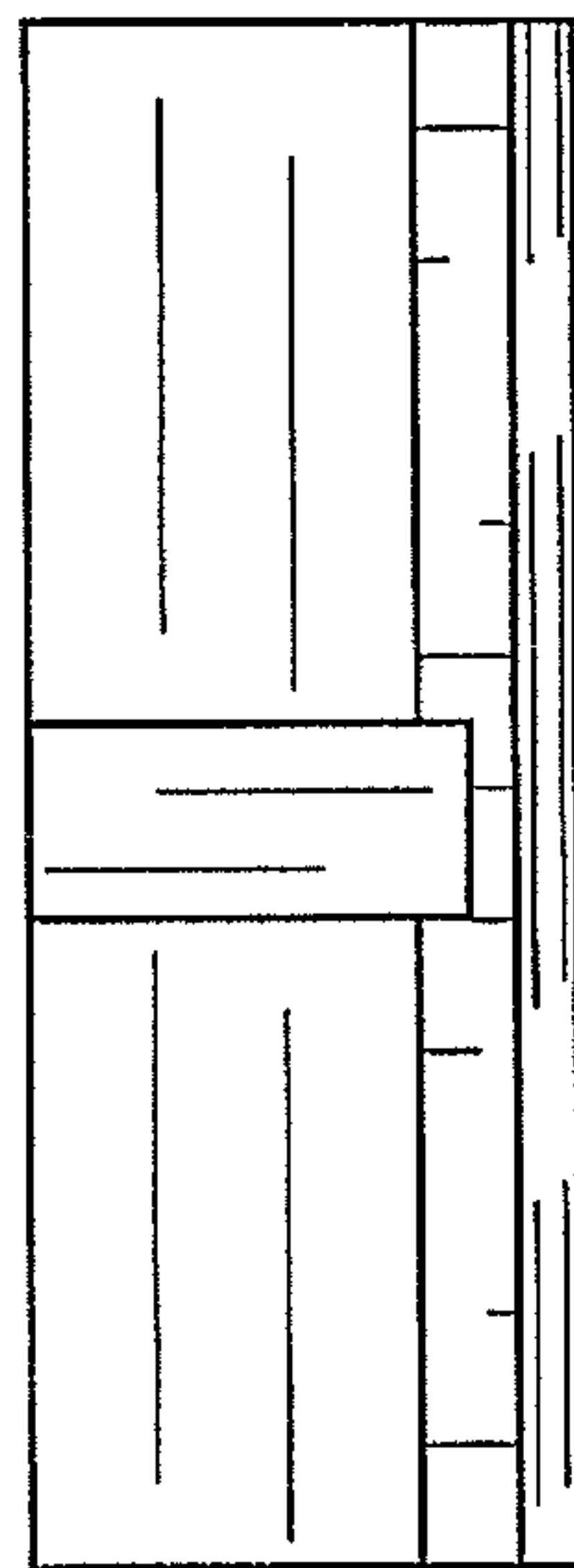

FIG. 13

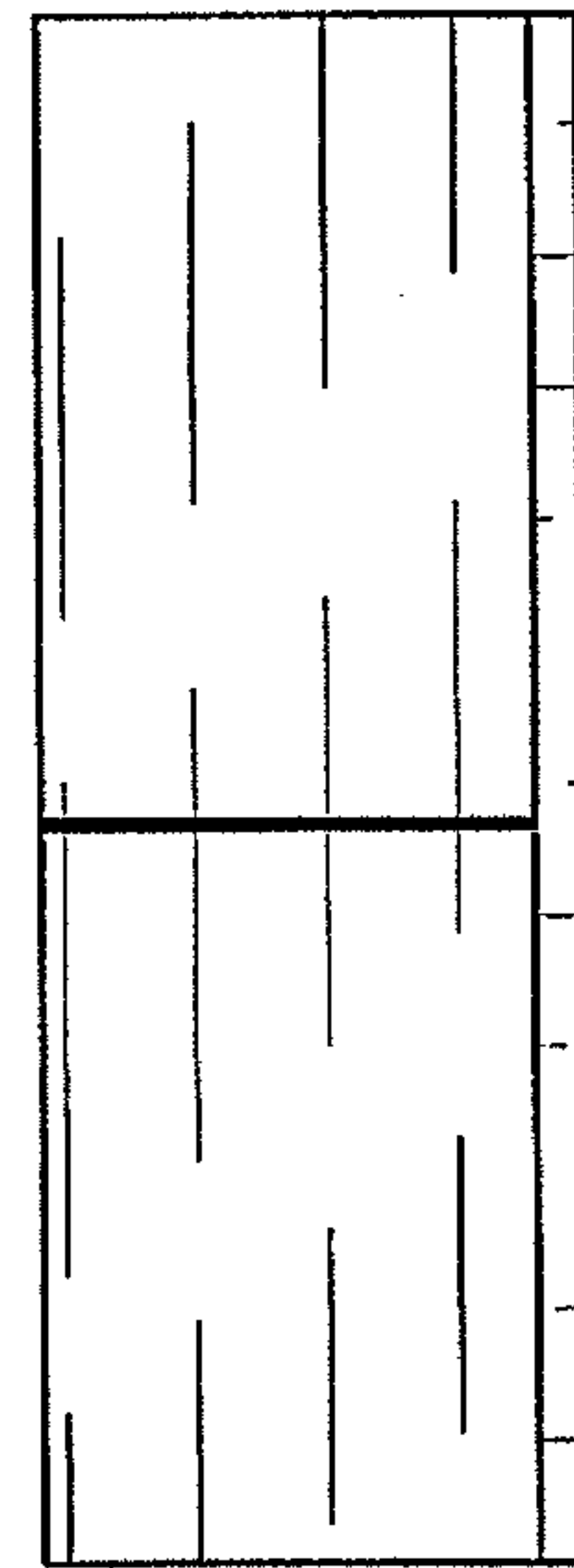

FIG. 14



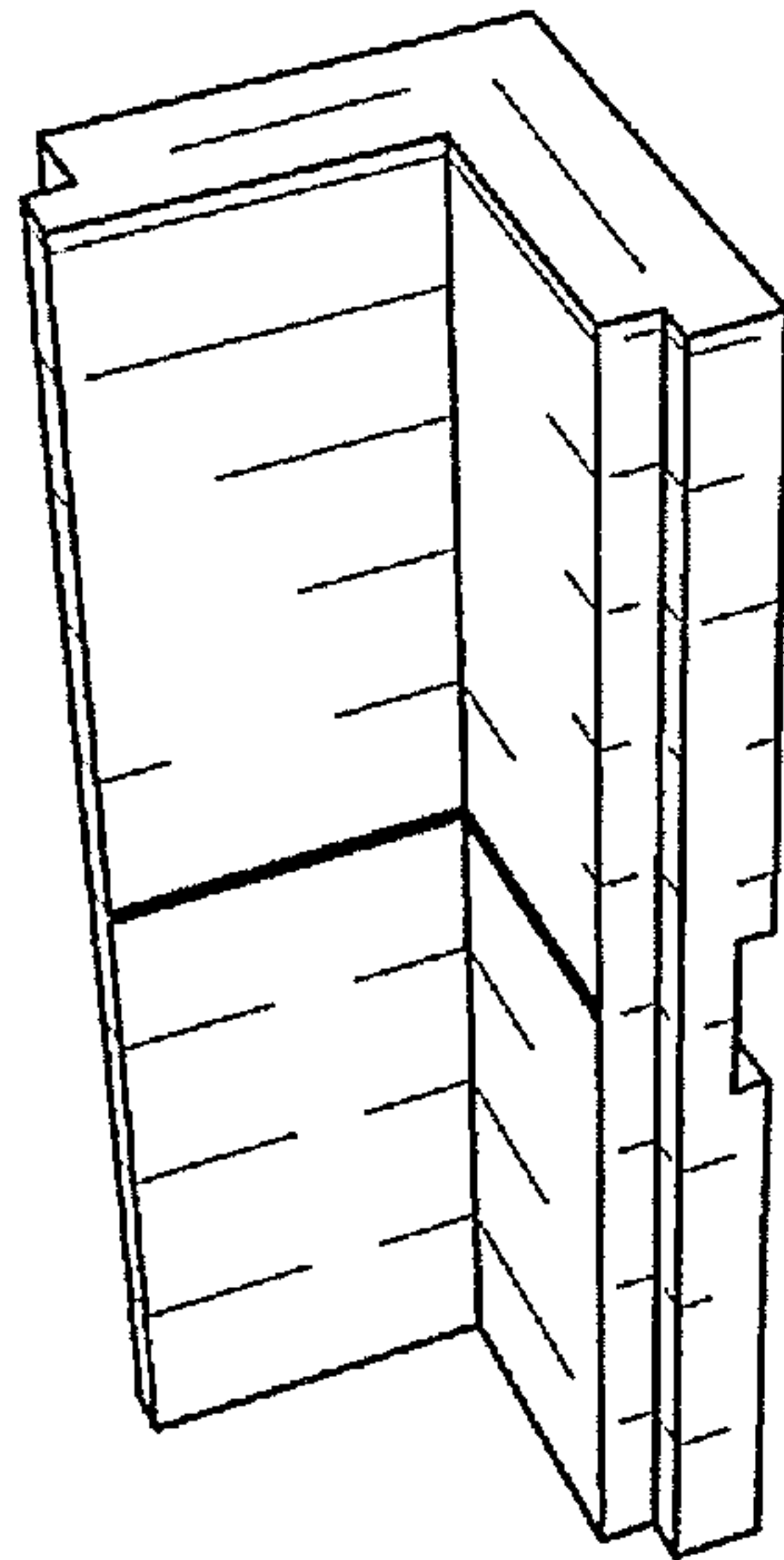

FIG. 15

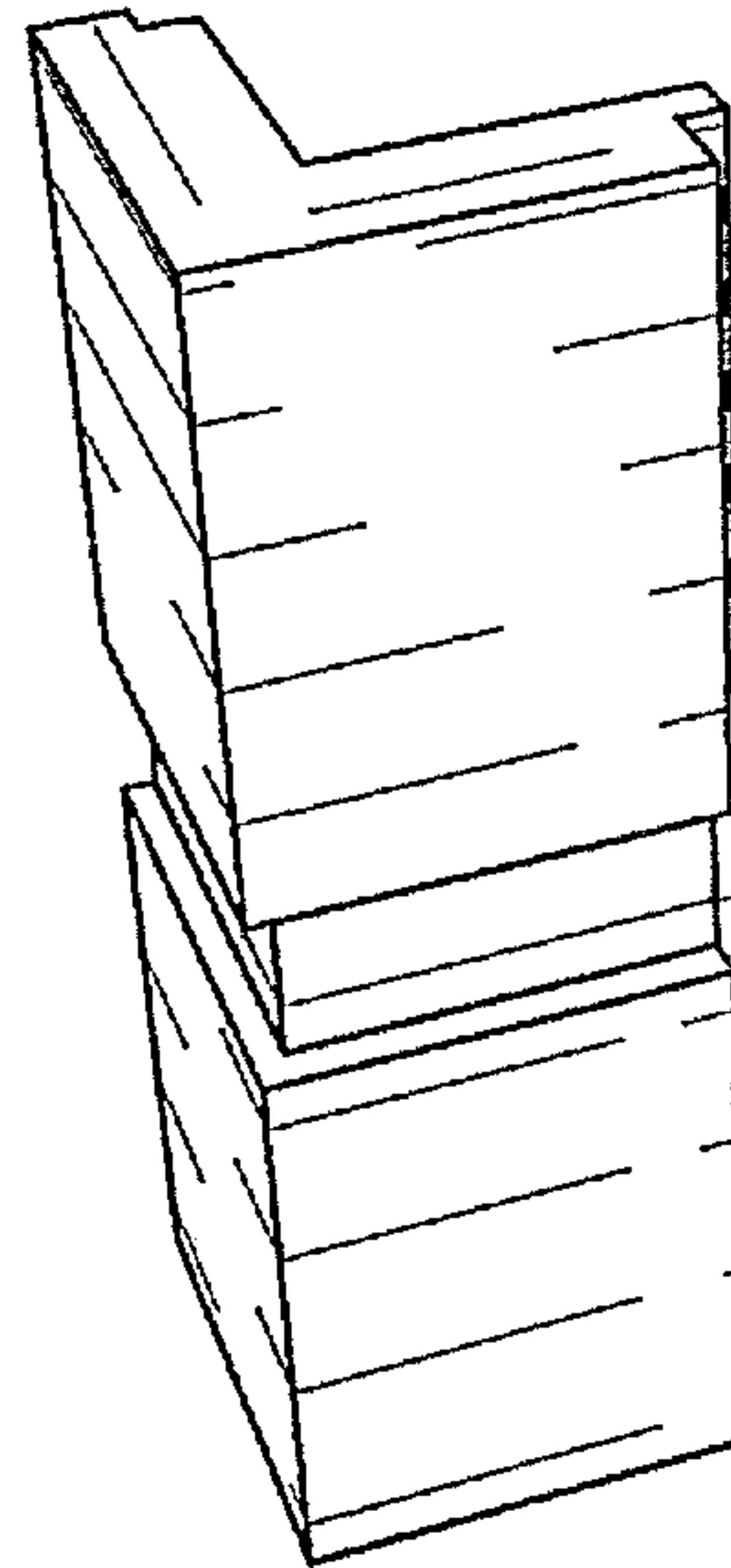

FIG. 16

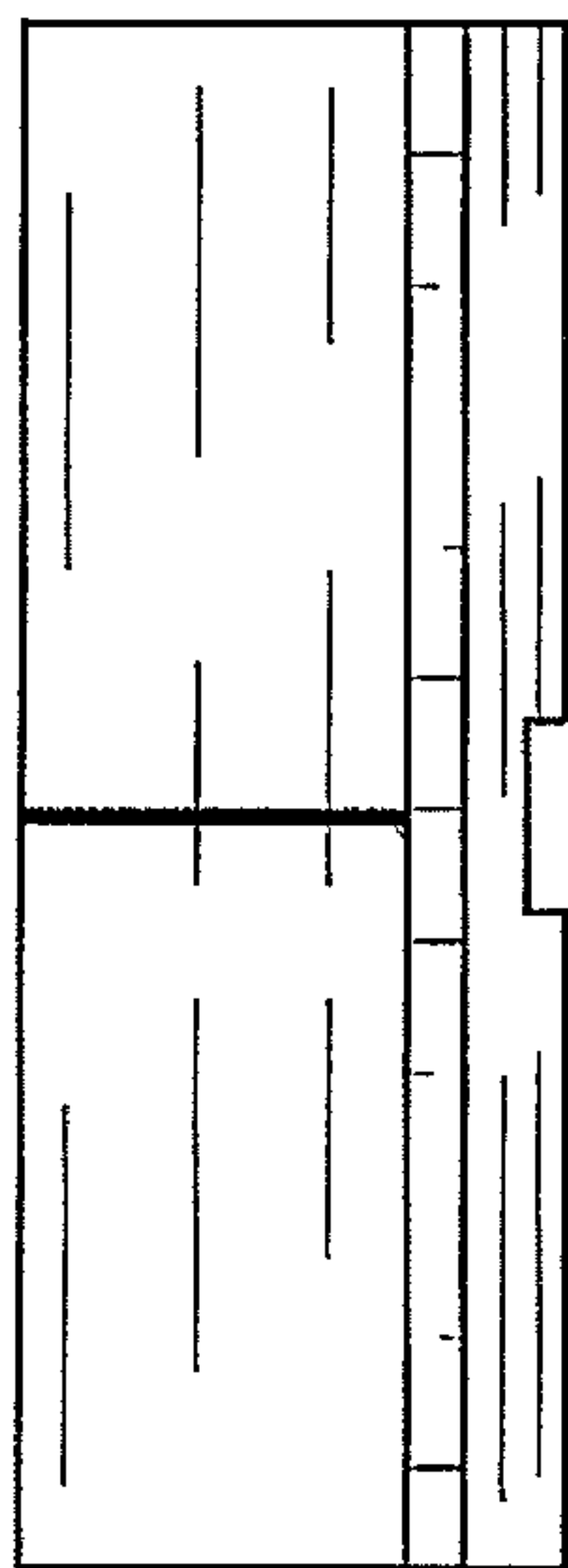

FIG. 17

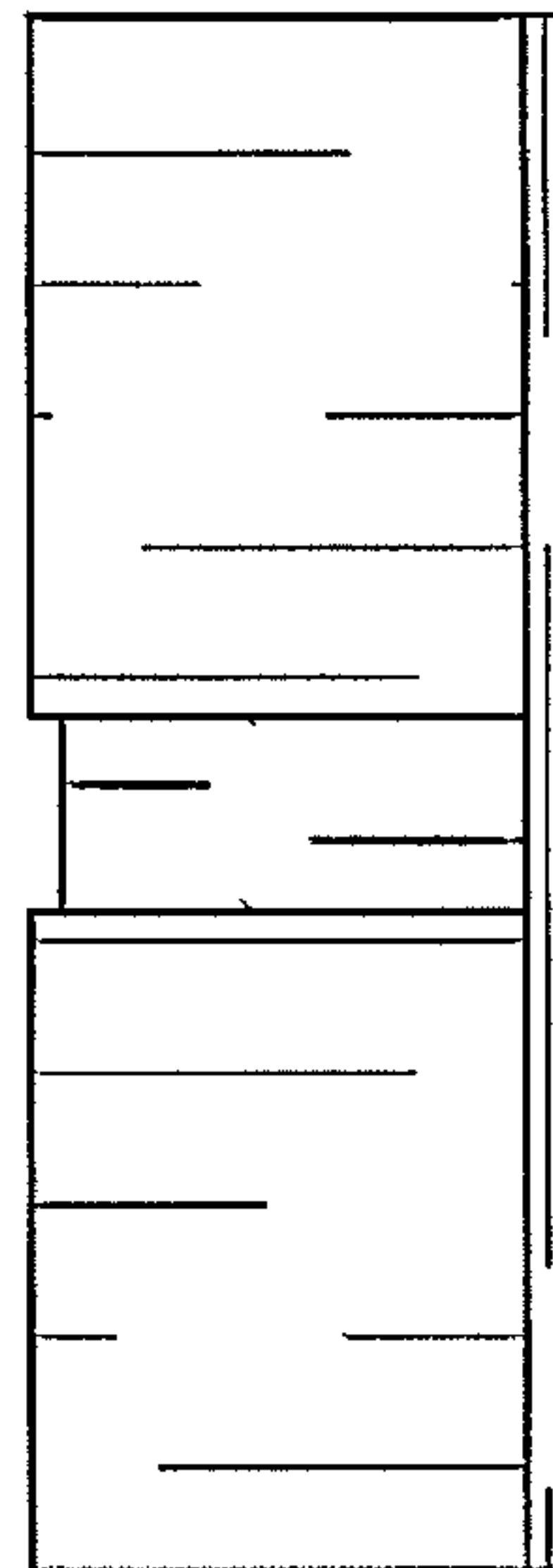

FIG. 18

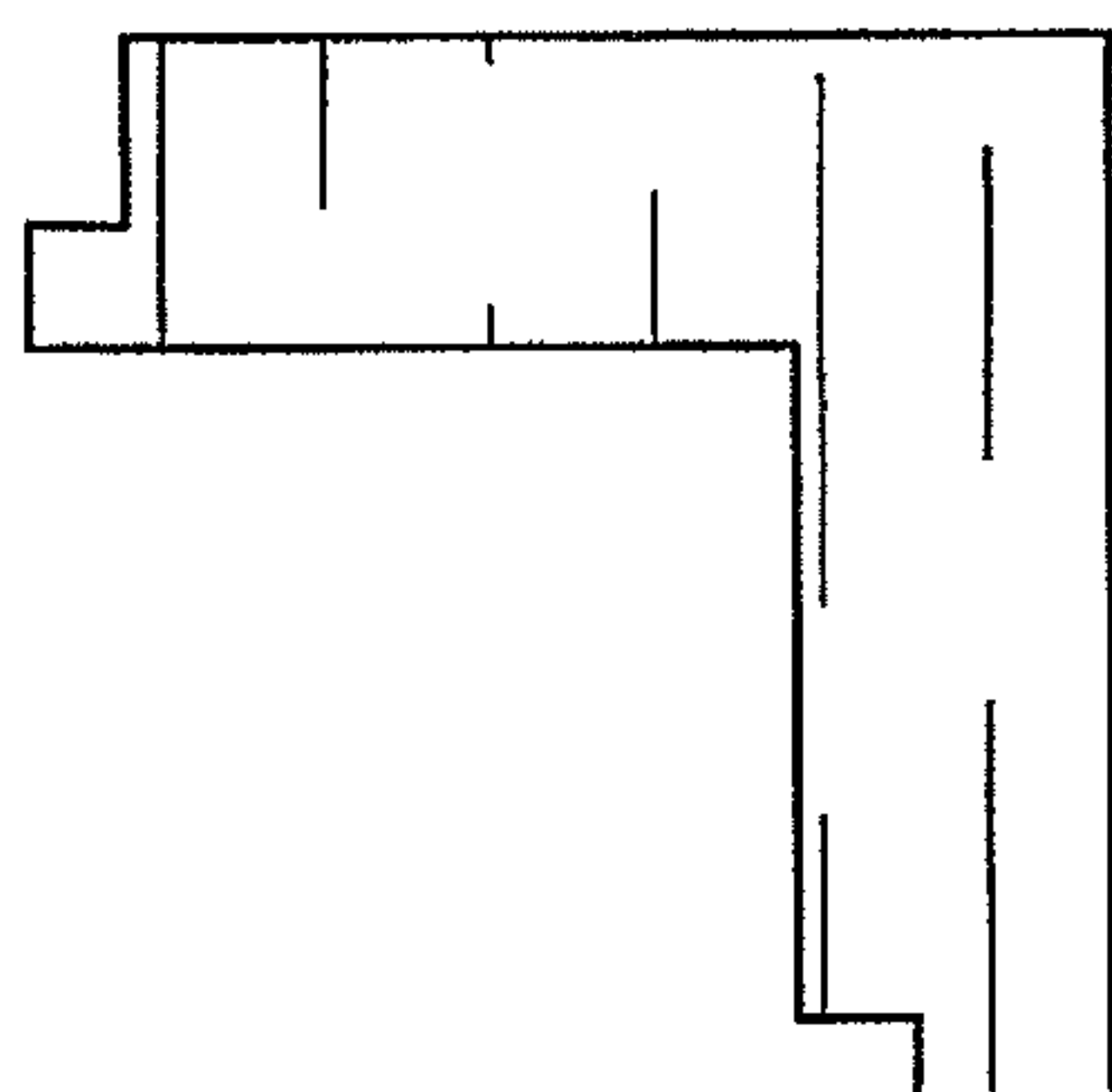

FIG. 19

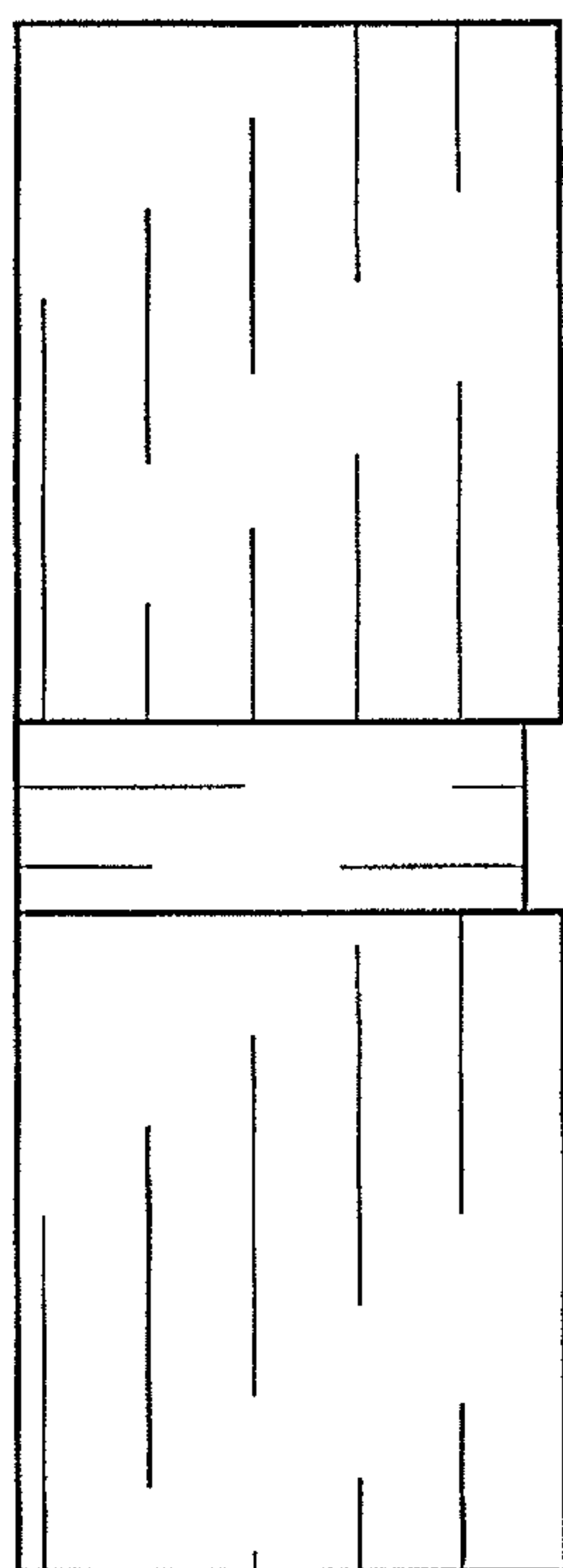

FIG. 20

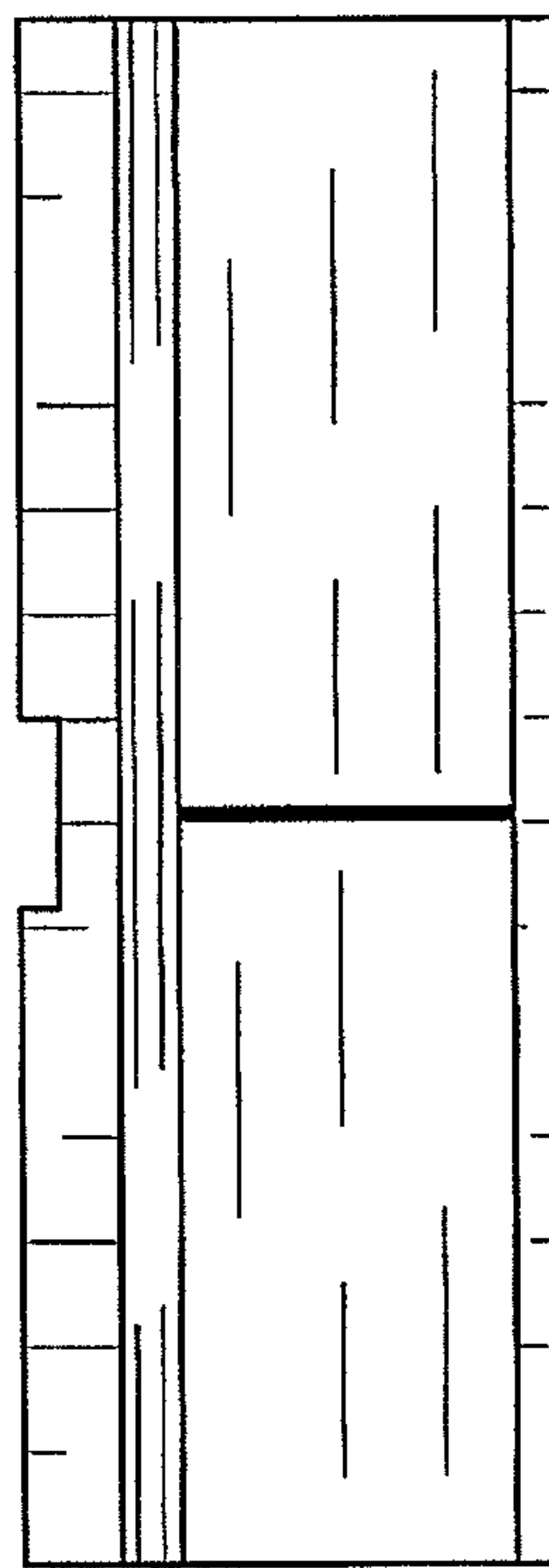

FIG. 21

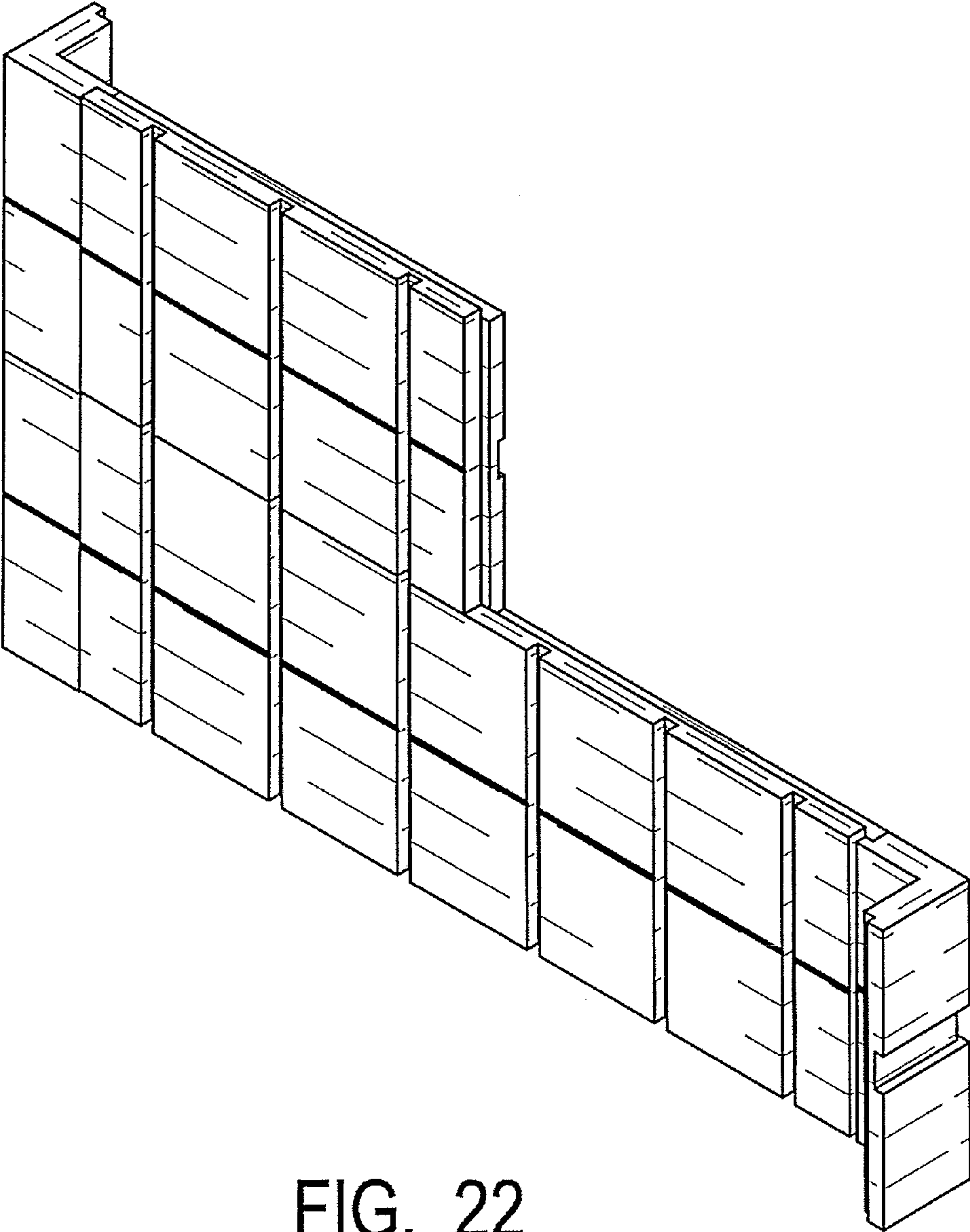

FIG. 22



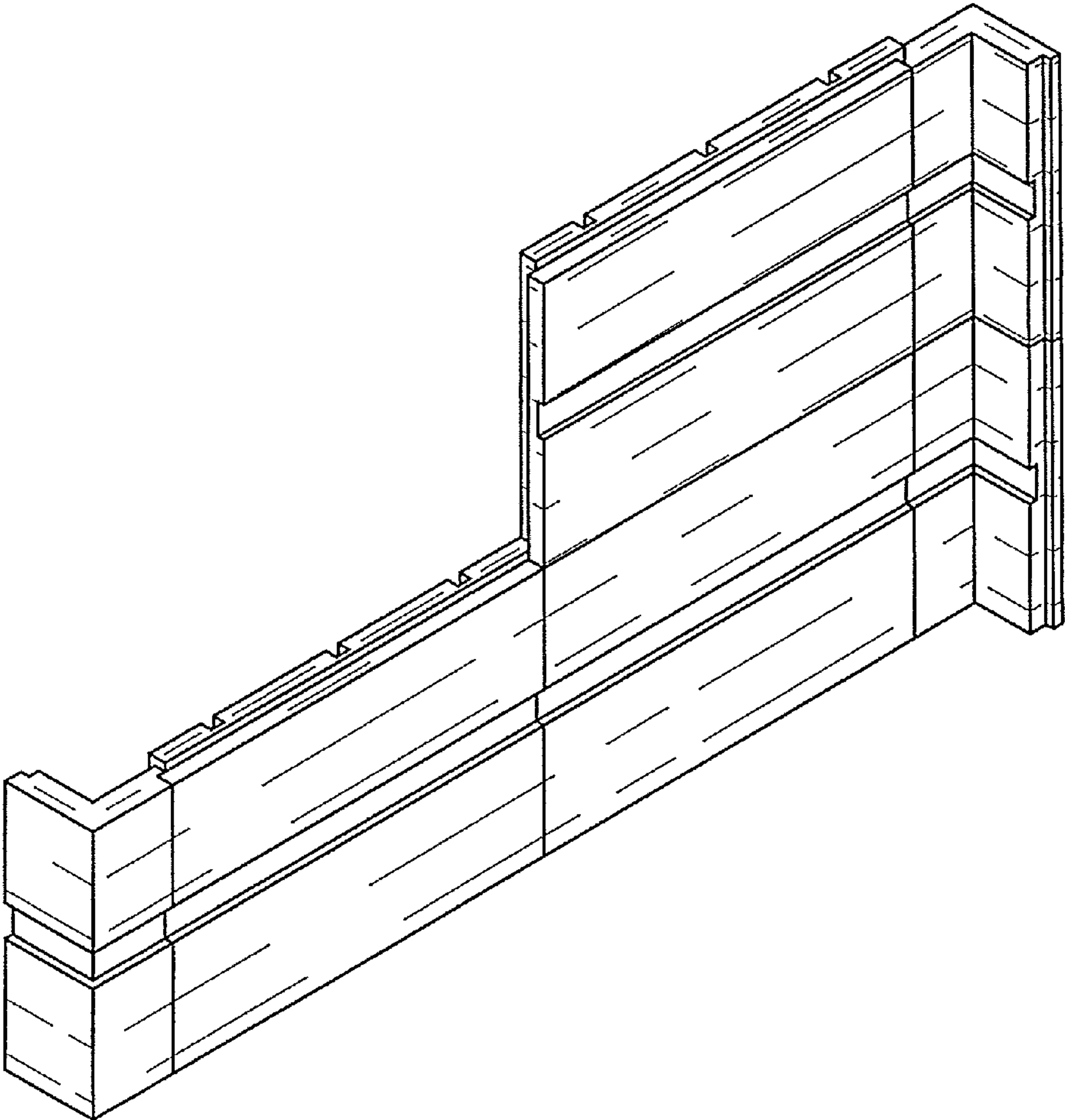

FIG. 23