



US00D710857S

(12) **United States Design Patent**
Mecchella et al.

(10) **Patent No.:** **US D710,857 S**
(45) **Date of Patent:** **** Aug. 12, 2014**

(54) **ELECTRONIC DEVICE COVER**
(75) Inventors: **Monica Liane Mecchella**, San Francisco, CA (US); **Wilfrido Loor Canizares**, San Francisco, CA (US); **Hoang M. Nguyen**, San Francisco, CA (US); **Christopher Green**, San Francisco, CA (US)

(73) Assignee: **Amazon Technologies, Inc.**, Reno, NV (US)

(**) Term: **14 Years**

(21) Appl. No.: **29/430,007**

(22) Filed: **Aug. 20, 2012**

(51) **LOC (10) Cl.** **14-02**

(52) **U.S. Cl.**
USPC **D14/440**

(58) **Field of Classification Search**
USPC D14/250, 251, 253, 240, 217, 496, 440, D14/203.3, 203.4, 203.5, 203.8, 341, 318; D3/218, 215, 201, 294, 289, 900; 220/4.02; 248/309.1; 361/679.56; 379/426, 433.11, 455; 455/575.1, 455/575.8; 190/100; 206/305, 320; D21/469

See application file for complete search history.

(56) **References Cited**

U.S. PATENT DOCUMENTS

2,354,782	A	8/1944	Stradling
4,259,568	A	3/1981	Dynesen
4,703,160	A	10/1987	Narishima et al.
4,718,550	A	1/1988	Johnson
D306,583	S	3/1990	Krolopp et al.
5,375,076	A	12/1994	Goodrich et al.
D435,550	S	12/2000	Chu et al.
D546,878	S	7/2007	Bharma
7,318,521	B2	1/2008	Lau
D579,975	S	11/2008	Brown

7,542,052	B2	6/2009	Solomon et al.
D600,699	S	9/2009	Johnston et al.
D641,348	S	7/2011	Kim et al.
D646,266	S	10/2011	Kim et al.
D652,831	S	1/2012	Lee et al.
D657,354	S	4/2012	Kim
D659,139	S	5/2012	Gengler
8,230,992	B2	7/2012	Law et al.
8,235,208	B2	8/2012	Sirichai et al.
D670,293	S *	11/2012	Shimizu et al. D14/440
D675,211	S *	1/2013	Rouser D14/440

(Continued)

OTHER PUBLICATIONS

Office action for U.S. Appl. No. 29/402,806, mailed on Sep. 12, 2012, Loor Canizares et al., "Electronic Device Cover", 8 pages.

(Continued)

Primary Examiner — Cynthia Underwood

(74) *Attorney, Agent, or Firm* — Lee & Hayes, PLLC

(57) **CLAIM**

The ornamental design for an electronic device cover, as shown and described.

DESCRIPTION

FIG. 1 is a perspective view of an electronic device cover for holding an electronic device;
FIG. 2 is a top plan view of the electronic device cover of FIG. 1;
FIG. 3 is a bottom plan view of the electronic device cover of FIG. 1;
FIG. 4 is a left-side elevation view of the electronic device cover of FIG. 1;
FIG. 5 is a right-side elevation view of the electronic device cover of FIG. 1;
FIG. 6 is a back elevation view of the electronic device cover of FIG. 1; and,
FIG. 7 is a front elevation view of the electronic device cover of FIG. 1.

1 Claim, 5 Drawing Sheets

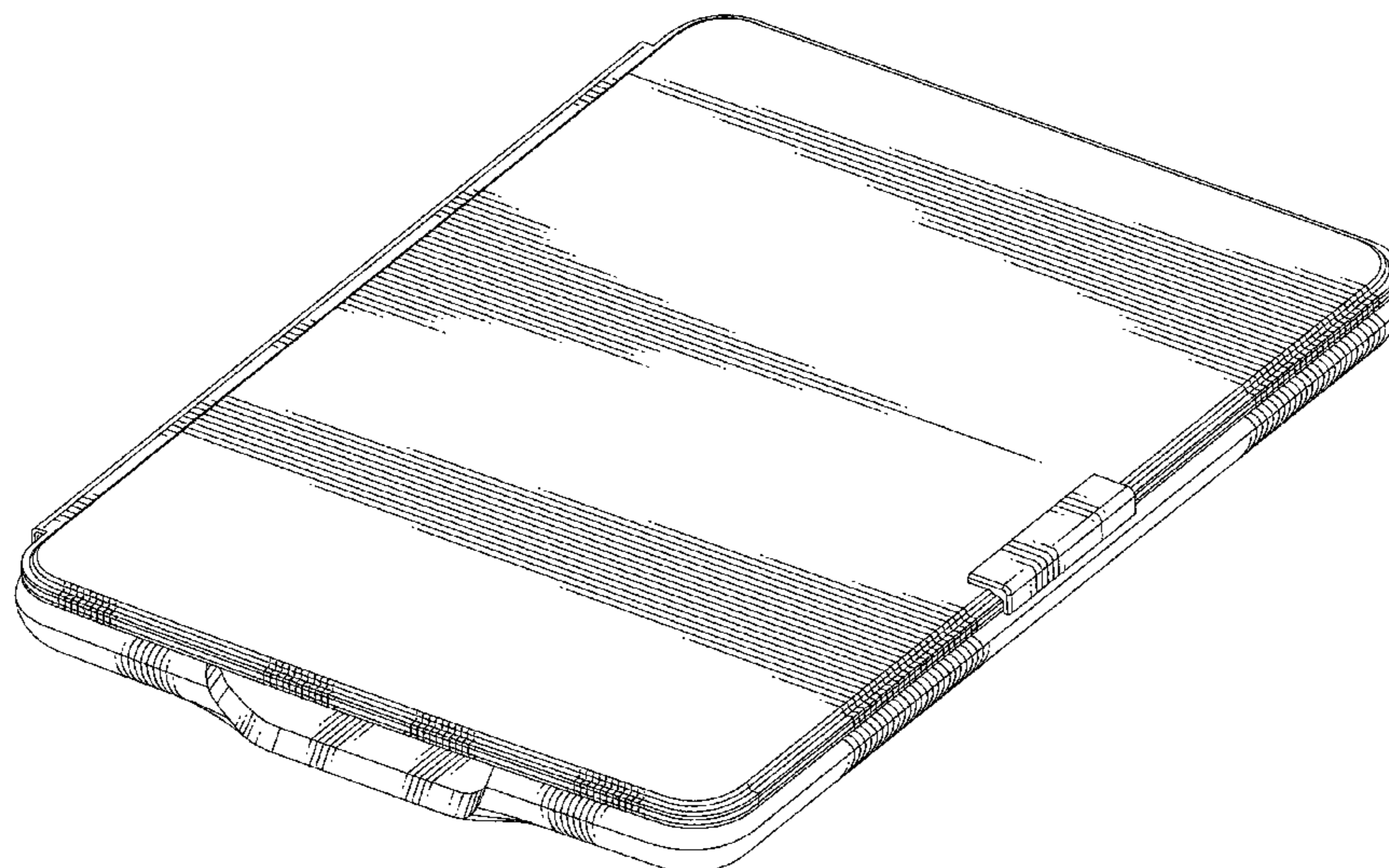

(56)

References Cited

U.S. PATENT DOCUMENTS

D685,799	S	*	7/2013	Canizares et al.	D14/440
D685,800	S	*	7/2013	Canizares et al.	D14/440
D685,801	S	*	7/2013	Canizares et al.	D14/440
D685,802	S	*	7/2013	Canizares et al.	D14/440
D696,670	S	*	12/2013	Schiller et al.	D14/440
2001/0040561	A1		11/2001	Weinzierl et al.		
2004/0202858	A1		10/2004	Lee		
2009/0017883	A1		1/2009	Lin		
2010/0294909	A1		11/2010	Hauser et al.		
2010/0300909	A1		12/2010	Hung		
2012/0043231	A1		2/2012	Perrier et al.		
2012/0194448	A1		8/2012	Rothkopf		

OTHER PUBLICATIONS

Office action for U.S. Appl. No. 29/402,809, mailed on Sep. 12, 2012, Loor Canizares et al., "Lighted Electronic Device Cover", 8 pages.
 Office action for U.S. Appl. No. 29/402,804, mailed on Sep. 14, 2012, Loor Canizares et al., "Lighted Electronic Device Cover", 8 pages.
 Office action for U.S. Appl. No. 29/402,800, mailed on Sep. 19, 2012, Loor Canizares et al., "Electronic Device Cover", 8 pages.

Japanese Office Action mailed May 25, 2012 for Japanese design application No. 2011-23924, a counterpart foreign application of Design U.S. Appl. No. 29/402,809, 5 pages.
 Japanese Office Action mailed May 25, 2012 for Japanese design application No. 2011-23922, a counterpart foreign application of Design U.S. Appl. No. 29/402,804, 5 pages.
 Japanese Office Action mailed May 25, 2012 for Japanese design application No. 2011-23923, a counterpart foreign application of Design U.S. Appl. No. 29/402,806, 5 pages.
 Japanese Office Action mailed May 25, 2012 for Japanese design application No. 2011-23921, a counterpart foreign application of Design U.S. Appl. No. 29/402,800, 5 pages.
 Office action for Design U.S. Appl. 29/402,806, mailed on Sep. 12, 2012, Loor Canizares et al., "Electronic Device Cover", 8 pages.
 Office action for Design U.S. Appl. No. 29/402,809, mailed on Sep. 12, 2012, Loor Canizares et al., "Lighted Electronic Device Cover", 8 pages.
 Office action for Design U.S. Appl. No. 29/402,804, mailed on Sep. 14, 2012, Loor Canizares et al., "Lighted Electronic Device Cover", 8 pages.
 Office action for Design U.S. Appl. No. 29/402,800, mailed on Sep. 19, 2012, Loor Canizares et al., "Electronic Device Cover", 8 pages.

* cited by examiner

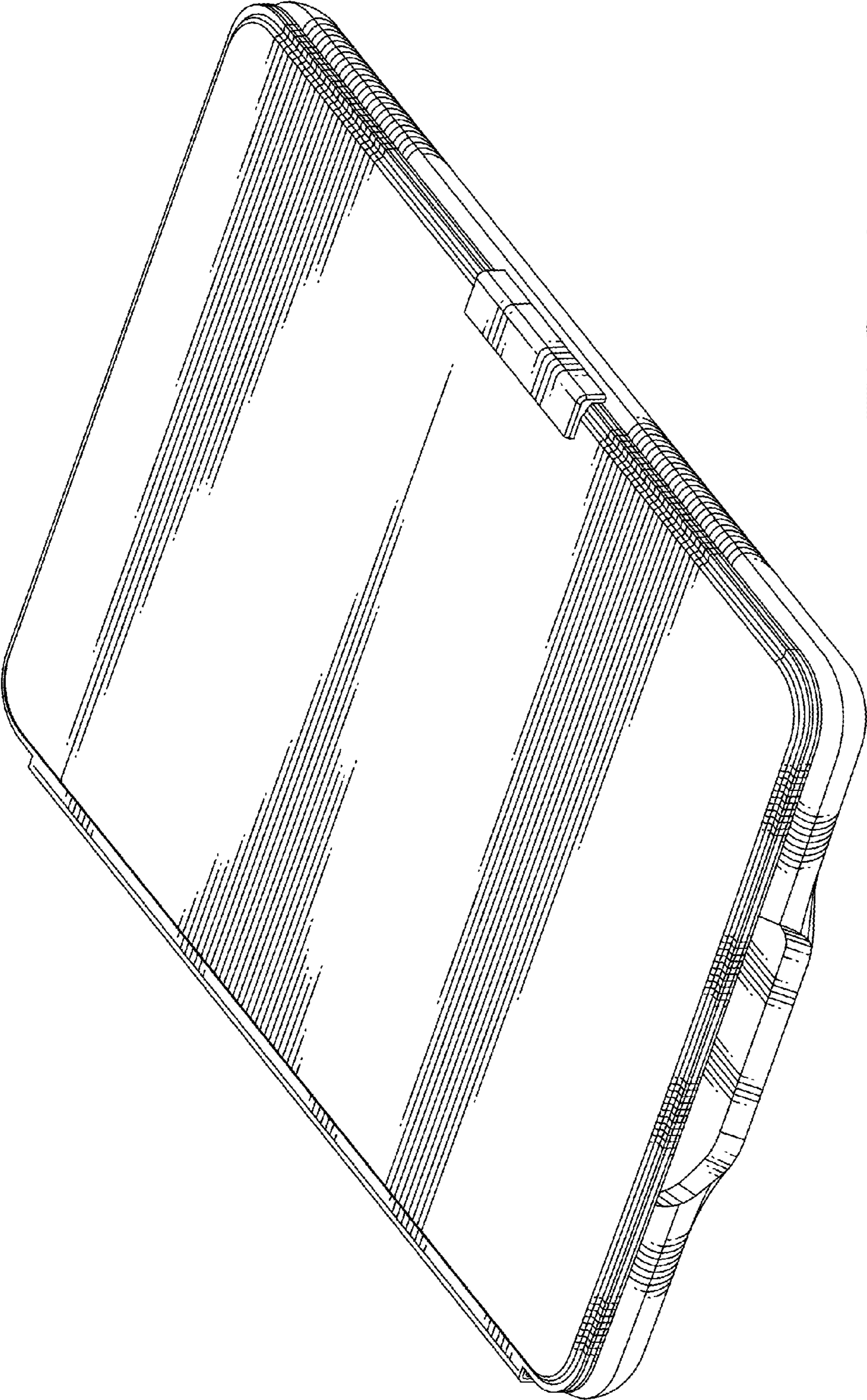

FIG. 1

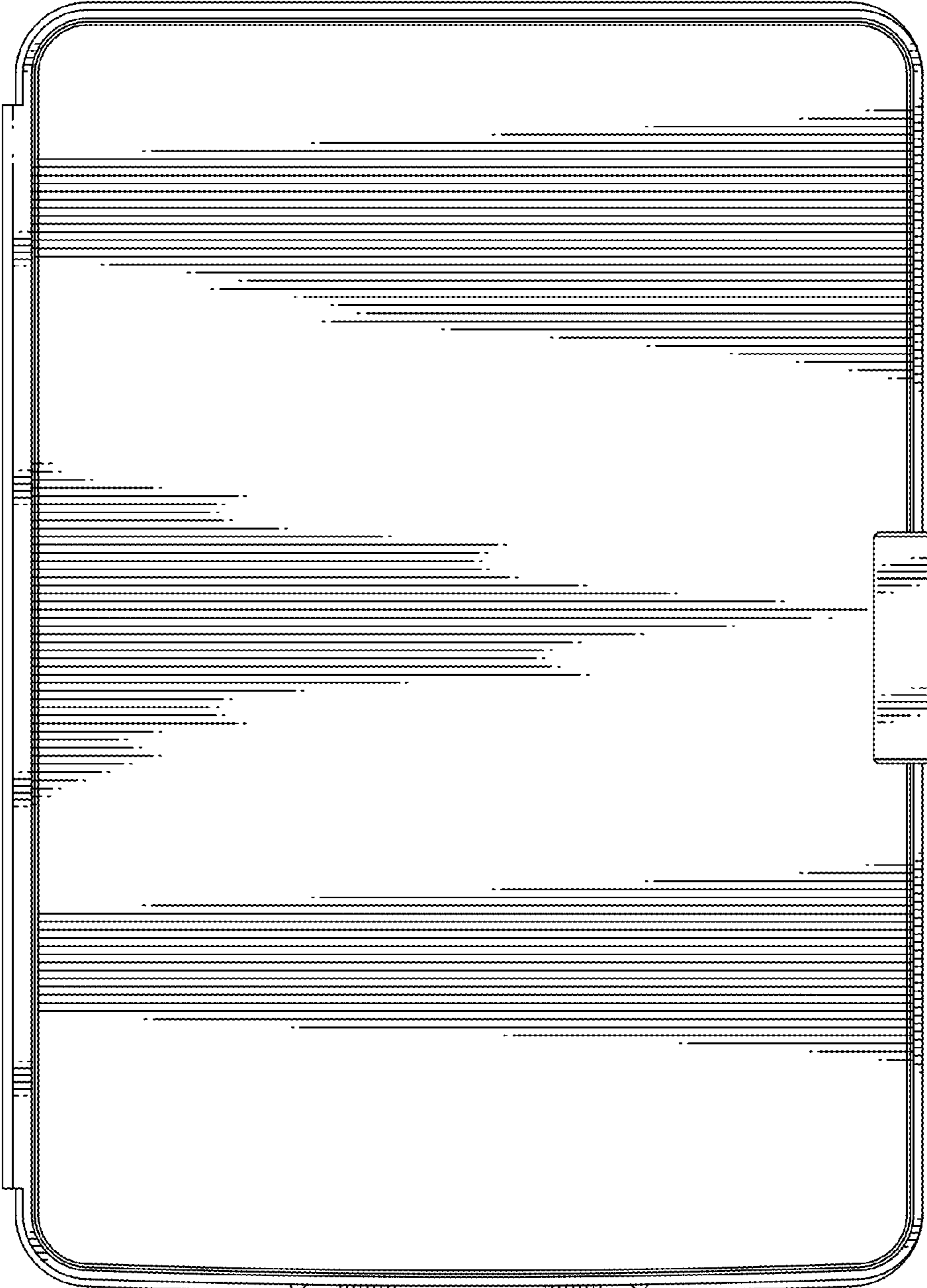

FIG. 2

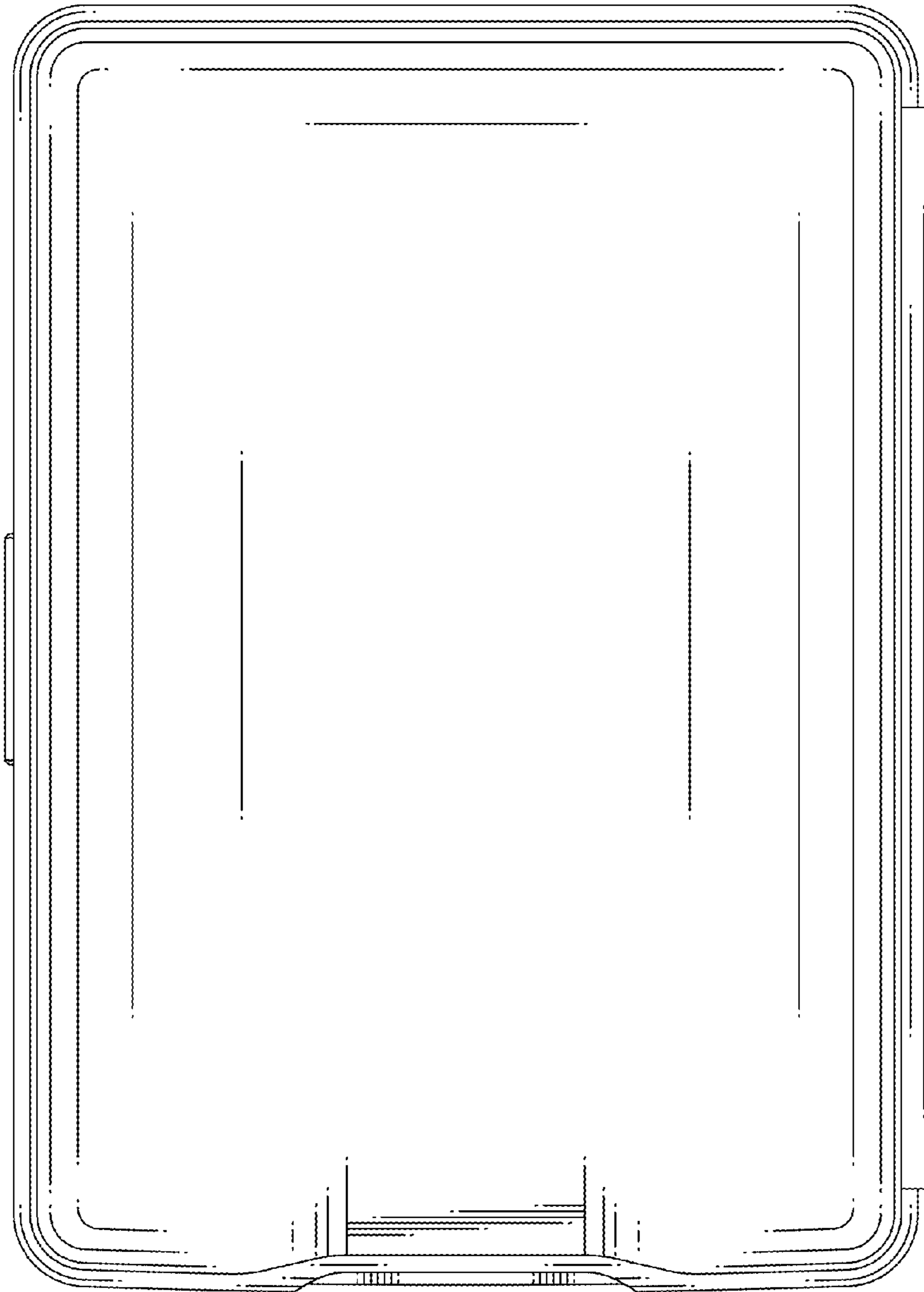

FIG. 3

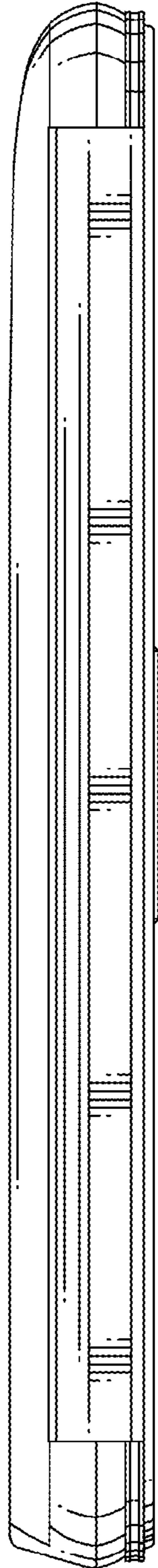

FIG. 4

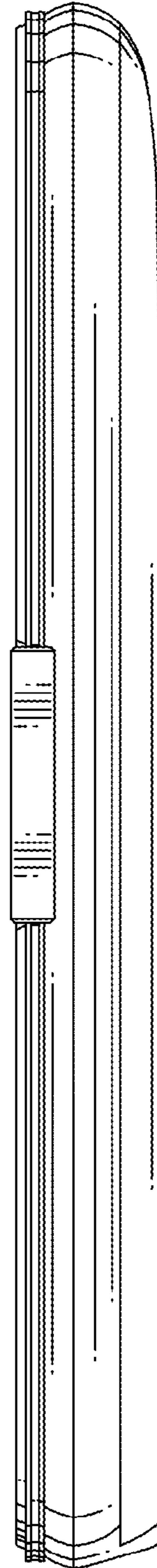

FIG. 5

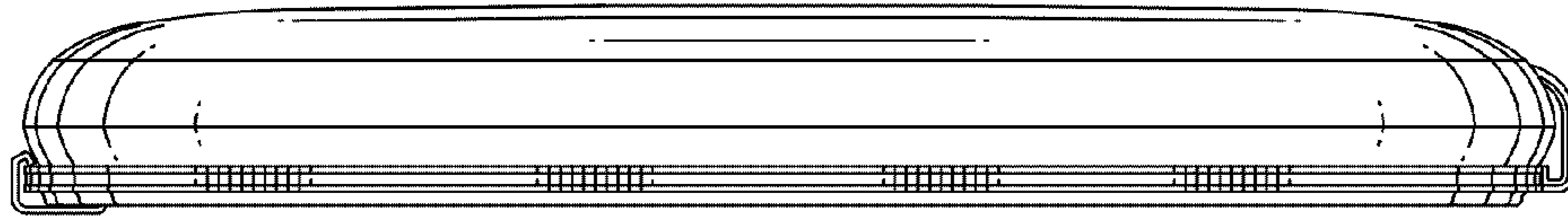

FIG. 6

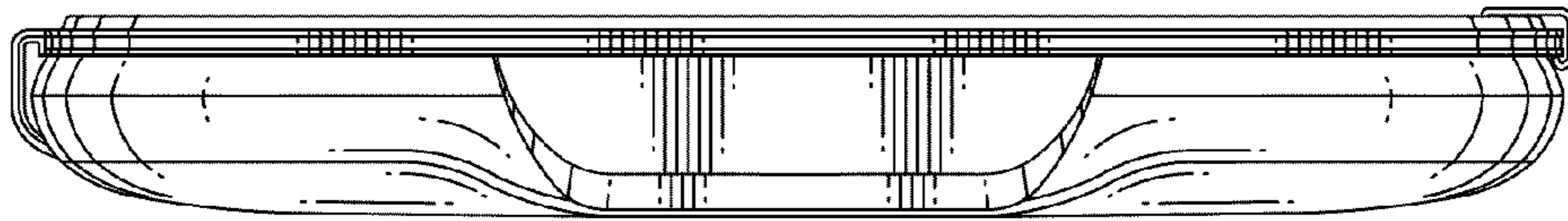

FIG. 7