



US00D710745S

(12) **United States Design Patent**
Weir

(10) **Patent No.:** **US D710,745 S**

(45) **Date of Patent:** **** Aug. 12, 2014**

(54) **EAGLE-SHAPED FLAG POLE FINIAL**

(71) Applicant: **Austin Weir**, Newport Beach, CA (US)

(72) Inventor: **Austin Weir**, Newport Beach, CA (US)

(**) Term: **14 Years**

(21) Appl. No.: **29/464,528**

(22) Filed: **Aug. 16, 2013**

(51) **LOC (10) Cl.** **11-05**

(52) **U.S. Cl.**
USPC **D11/181**

(58) **Field of Classification Search**
USPC D11/165–183; D20/16, 17, 27, 28, 30,
D20/31, 36, 41–43; 40/218, 584, 604,
40/606.1, 606.15, 607.01, 607.03, 607.05;
116/173–175; 284/200, 218.4, 511
See application file for complete search history.

(56) **References Cited**

U.S. PATENT DOCUMENTS

744,977	A *	11/1903	Nourse	116/174
D51,325	S *	10/1917	Weller	D11/182
D59,878	S *	11/1921	Travers	D12/199
D70,243	S *	5/1926	Smith	D11/174
1,748,625	A *	2/1930	Troth	116/173
D138,915	S *	9/1944	Zinser	D11/137
D201,888	S *	8/1965	Faulhaber	D11/182
D243,992	S *	4/1977	Baxter	D7/639

D244,014	S *	4/1977	Kim	D11/182
5,168,828	A *	12/1992	Smyly, Sr.	116/173
7,434,971	B1 *	10/2008	Wang	362/496
8,172,422	B2	5/2012	Kim		
8,567,337	B2 *	10/2013	Chen	116/174
2006/0086308	A1 *	4/2006	Chen	116/174
2008/0013306	A1	1/2008	Guilmette		

* cited by examiner

Primary Examiner — Karen S Acker

(74) *Attorney, Agent, or Firm* — Eric Karich

(57) **CLAIM**

The ornamental design for an “eagle-shaped flag pole finial,” as shown and described.

DESCRIPTION

FIG. 1 is a perspective view of a eagle-shaped flag pole finial, showing my new design;
FIG. 2 is a front elevational view thereof;
FIG. 3 is a rear elevational view thereof;
FIG. 4 is a left side elevational view thereof
FIG. 5 is a right side elevational view thereof;
FIG. 6 is a top plan view thereof; and,
FIG. 7 is a bottom plan view thereof.

The broken lines in the drawings represent unclaimed portions of the eagle-shaped flag pole finial and form no part of the claimed design. The broken lines representing a mounting post represent unclaimed environmental subject matter and form no part of the claimed design.

1 Claim, 3 Drawing Sheets

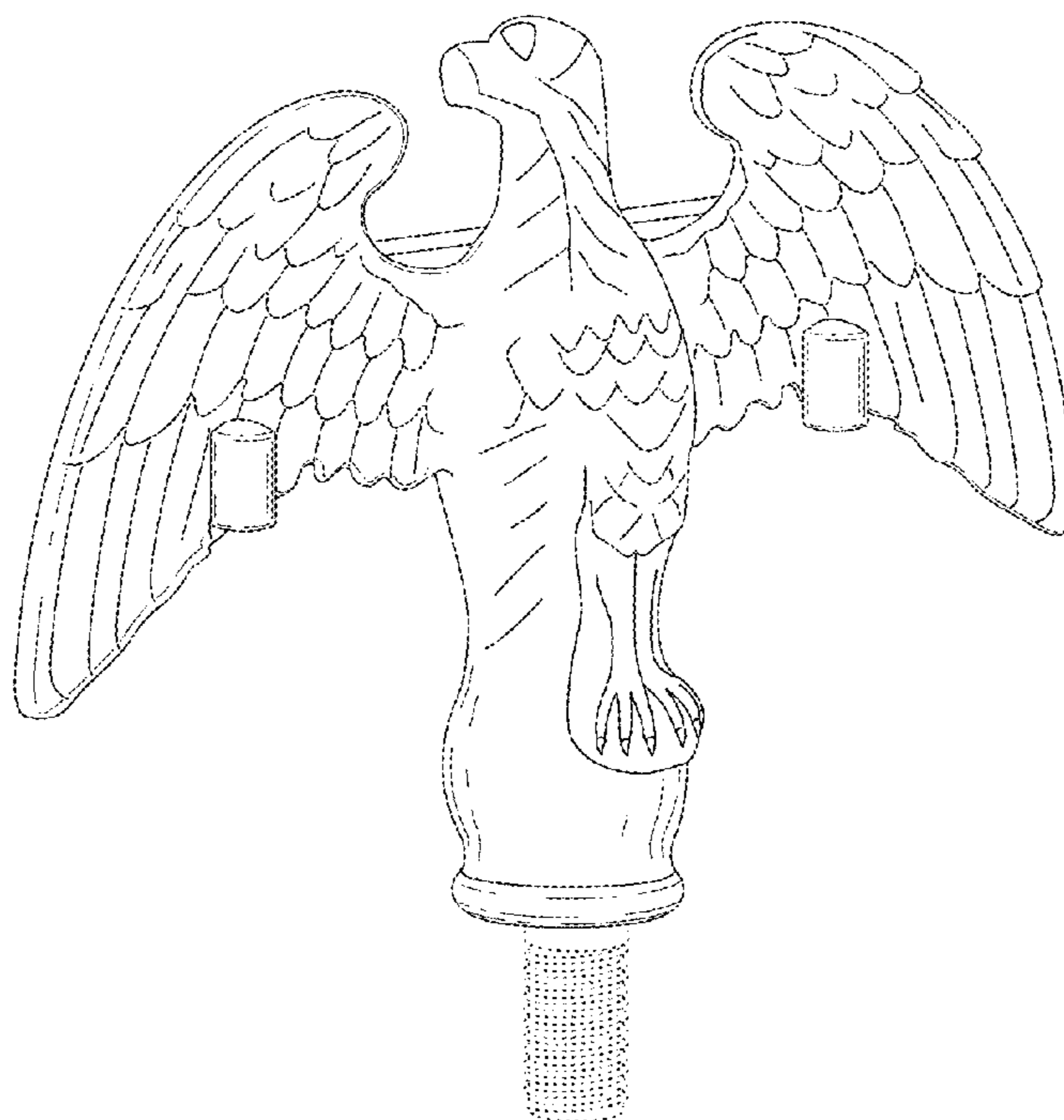

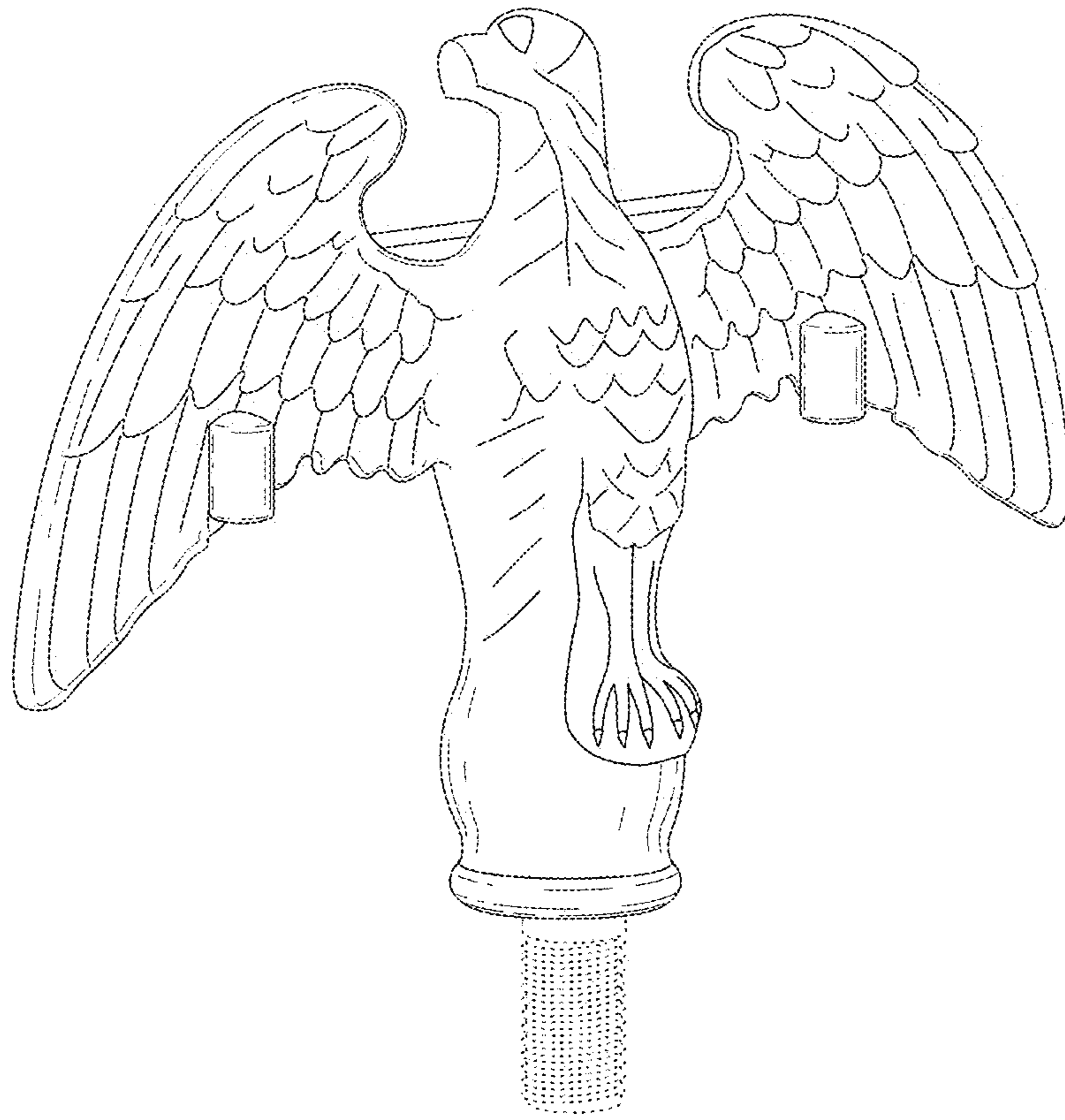

Fig. 1

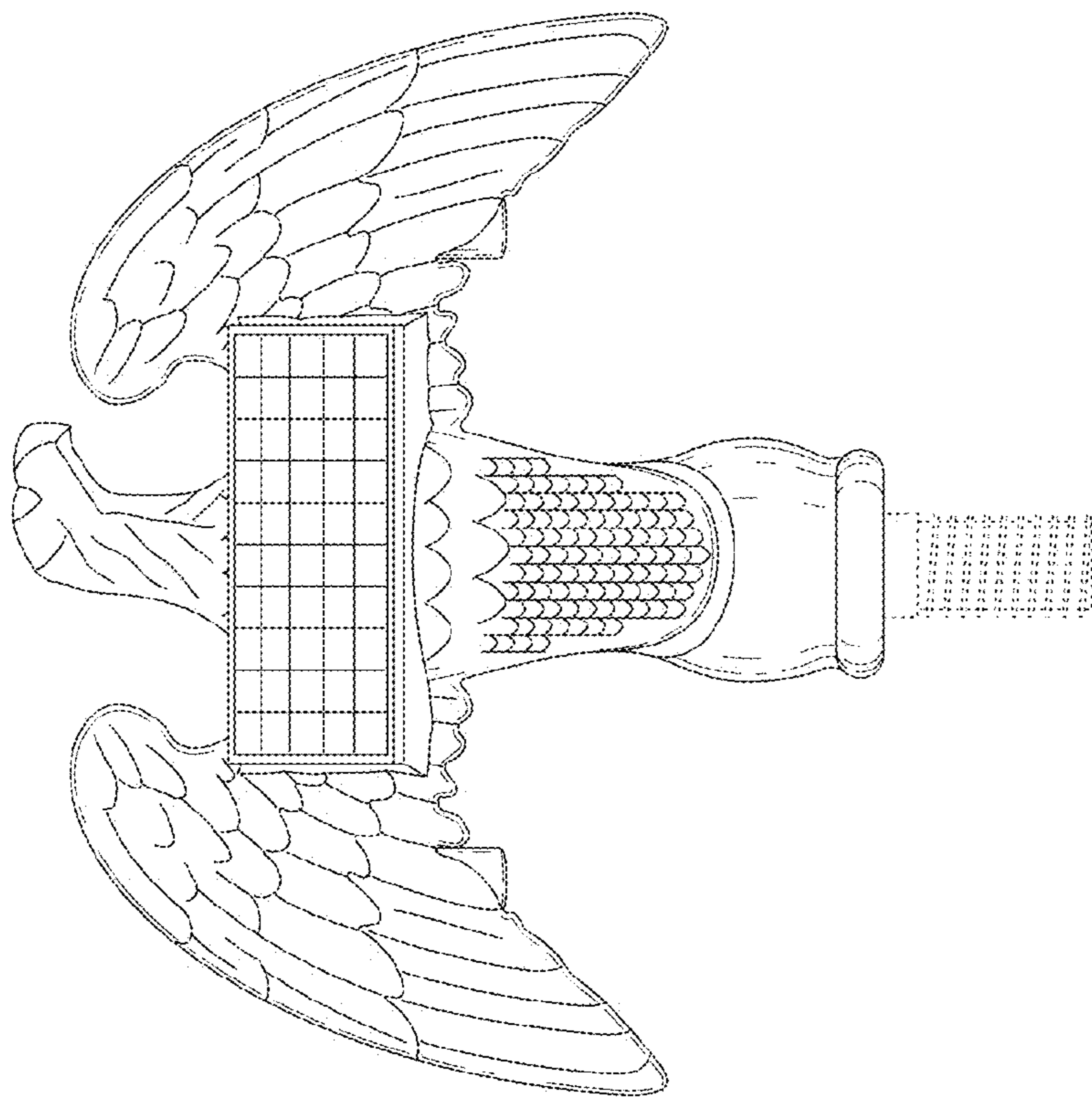

Fig. 2

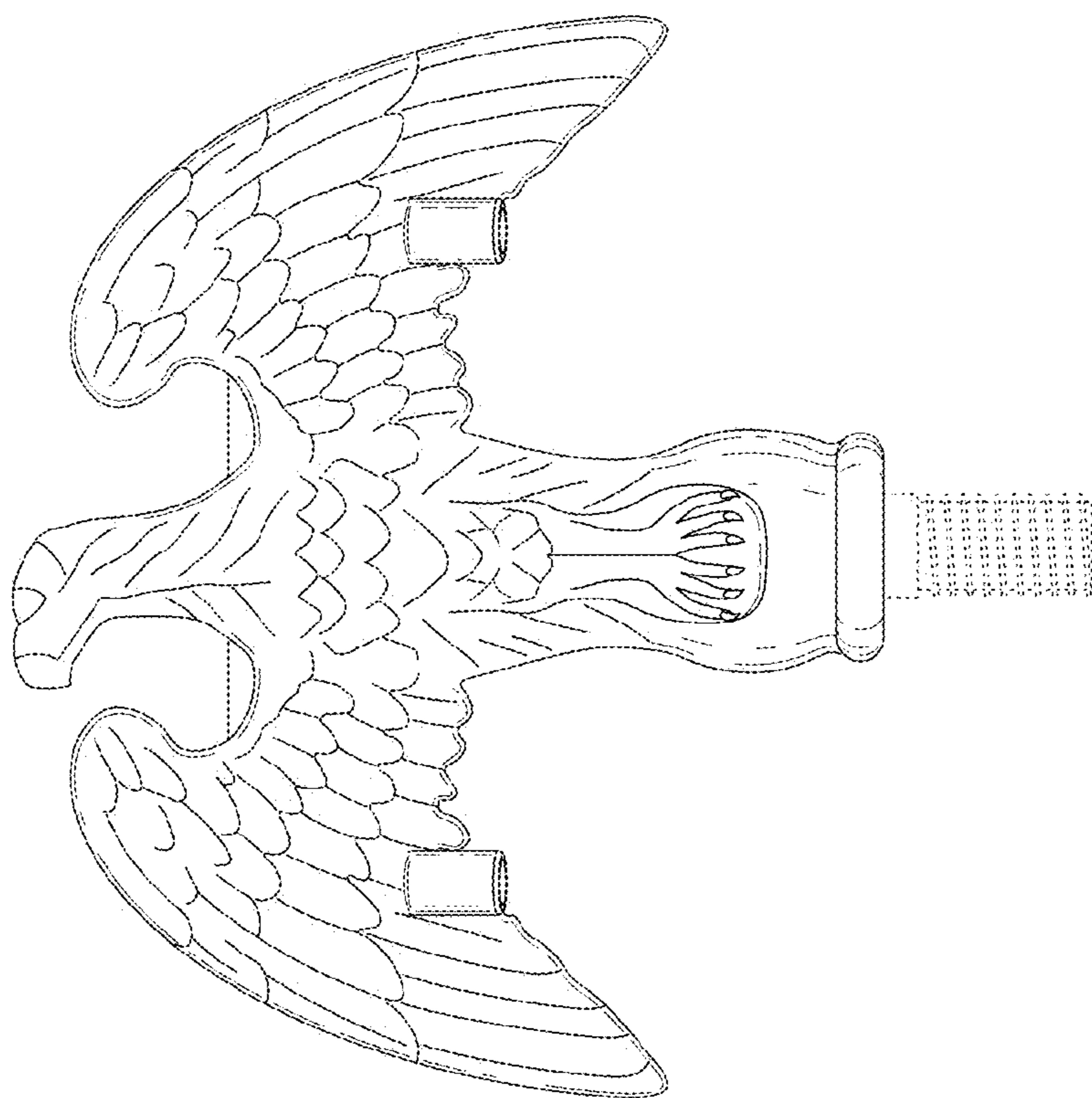

Fig. 3

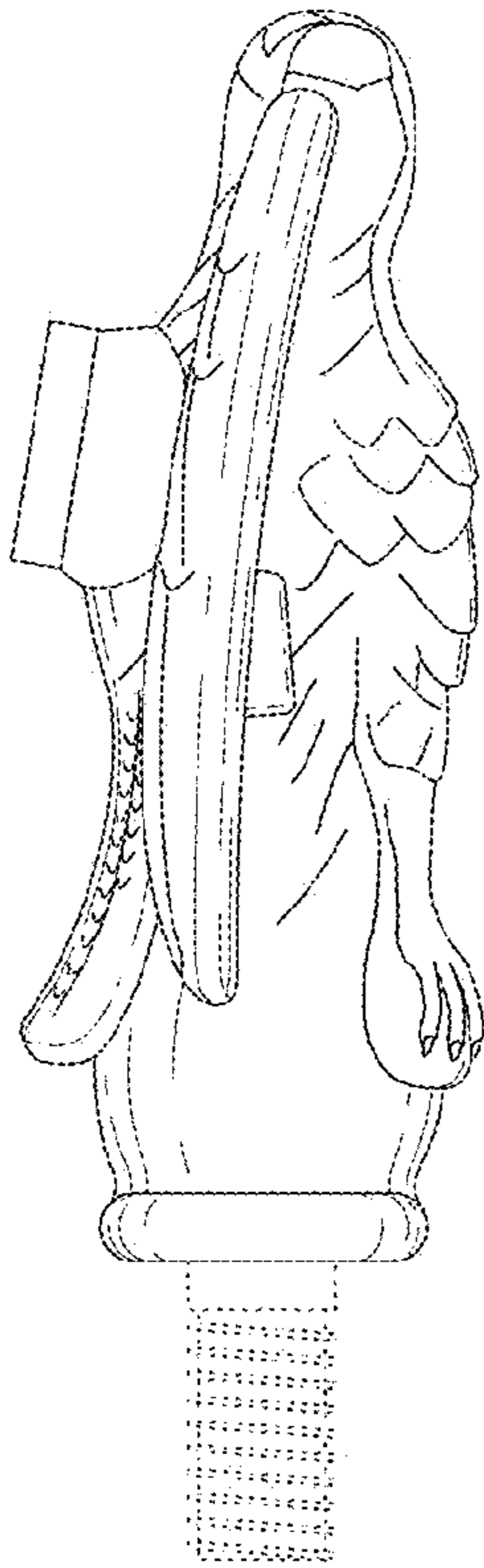

Fig. 4

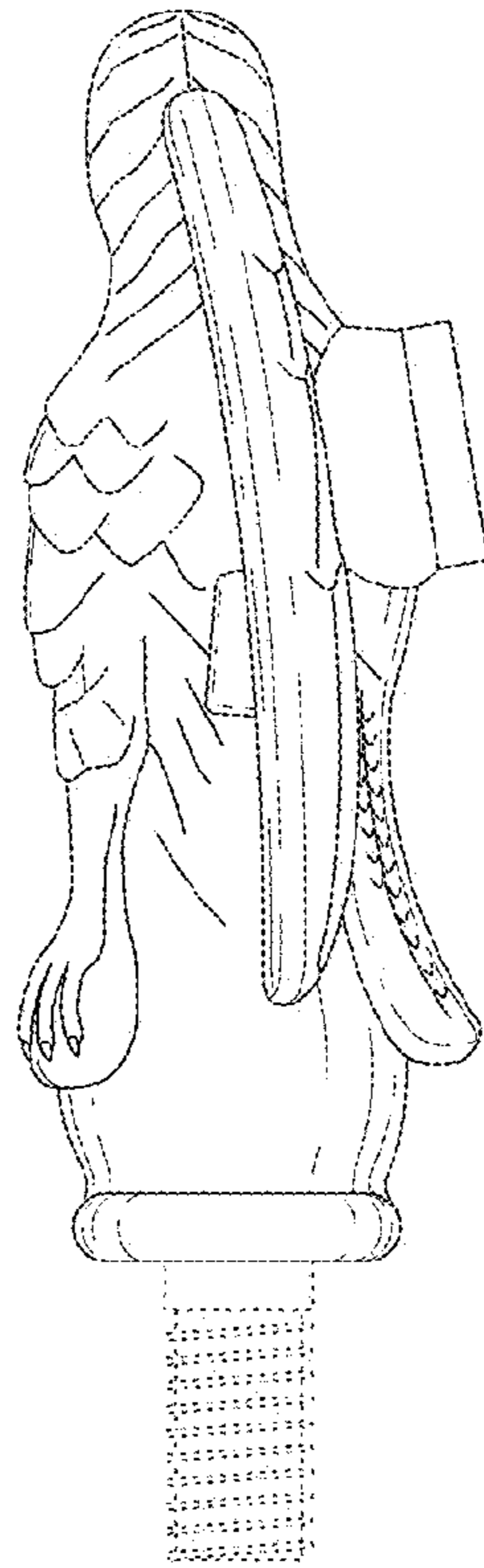

Fig. 5

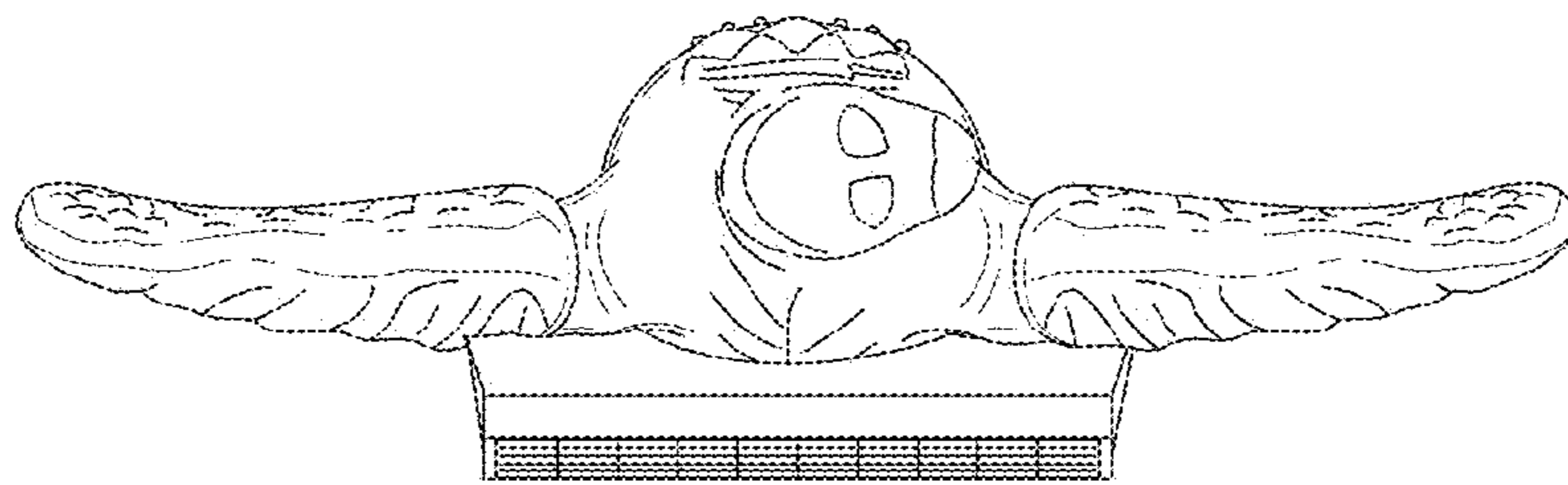

Fig. 6

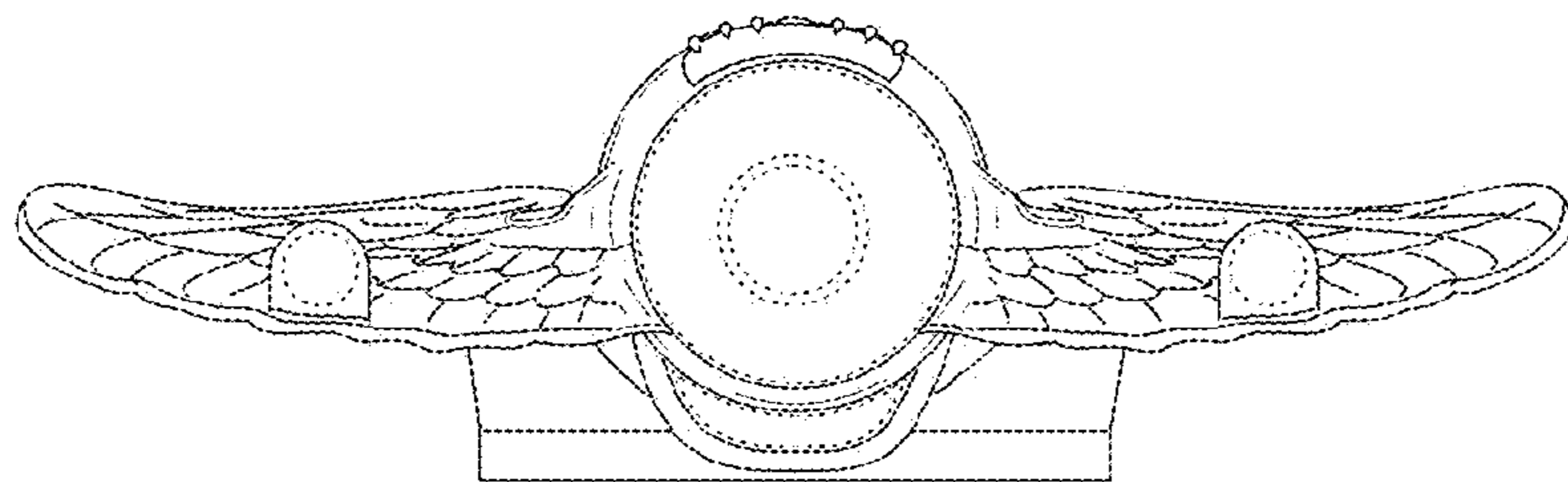

Fig. 7