



US00D710707S

(12) **United States Design Patent**
Colloud

(10) **Patent No.:** **US D710,707 S**

(45) **Date of Patent:** **** Aug. 12, 2014**

(54) **BOTTLE**

(56)

References Cited

U.S. PATENT DOCUMENTS

(71) Applicant: **Societe Anonyme des Eaux Minerales**
d'Evian, Evian les Bains (FR)

D332,225 S *	1/1993	Perret	D9/553
D370,178 S *	5/1996	Petre et al.	D9/552
D395,002 S *	6/1998	Monahan	D9/649
D422,490 S *	4/2000	Nemeth et al.	D9/649
D440,151 S *	4/2001	Carver et al.	D9/649
D458,144 S *	6/2002	Trabal	D9/554
D534,432 S *	1/2007	Wallwork	D9/552
D538,671 S *	3/2007	O'Danahue	D9/538
D549,107 S *	8/2007	Bourne	D9/538
D630,519 S *	1/2011	Toms et al.	D9/649

(72) Inventor: **Alain Colloud**, Reyvroz (FR)

(73) Assignee: **Societe Anonyme des Eaux Minerales**
d'Evian, Evian les Bains (FR)

(**) Term: **14 Years**

* cited by examiner

(21) Appl. No.: **29/450,774**

Primary Examiner — Sandra Morris

(22) Filed: **Mar. 22, 2013**

(74) *Attorney, Agent, or Firm* — DLA Piper LLP US; Gianni Minutoli

(51) **LOC (10) Cl.** **09-01**

(57) **CLAIM**

The ornamental design for a bottle, as shown and described.

(52) **U.S. Cl.**

DESCRIPTION

USPC **D9/649**; D9/554

(58) **Field of Classification Search**

USPC D7/514–515, 613, 619.2, 901; D9/600,
D9/649, 500–505, 516, 519, 537–540,
D9/544–545, 548, 549–558, 574–585;
206/457, 527, 540; 220/890

FIG. 1 is a perspective view of a bottle.
FIG. 2 is a front view of the bottle.
FIG. 3 is a rear view of the bottle.
FIG. 4 is a right view of the bottle.
FIG. 5 is a left view of the bottle.
FIG. 6 is a top view of the bottle; and,
FIG. 7 is a bottom view of the bottle.

See application file for complete search history.

1 Claim, 7 Drawing Sheets

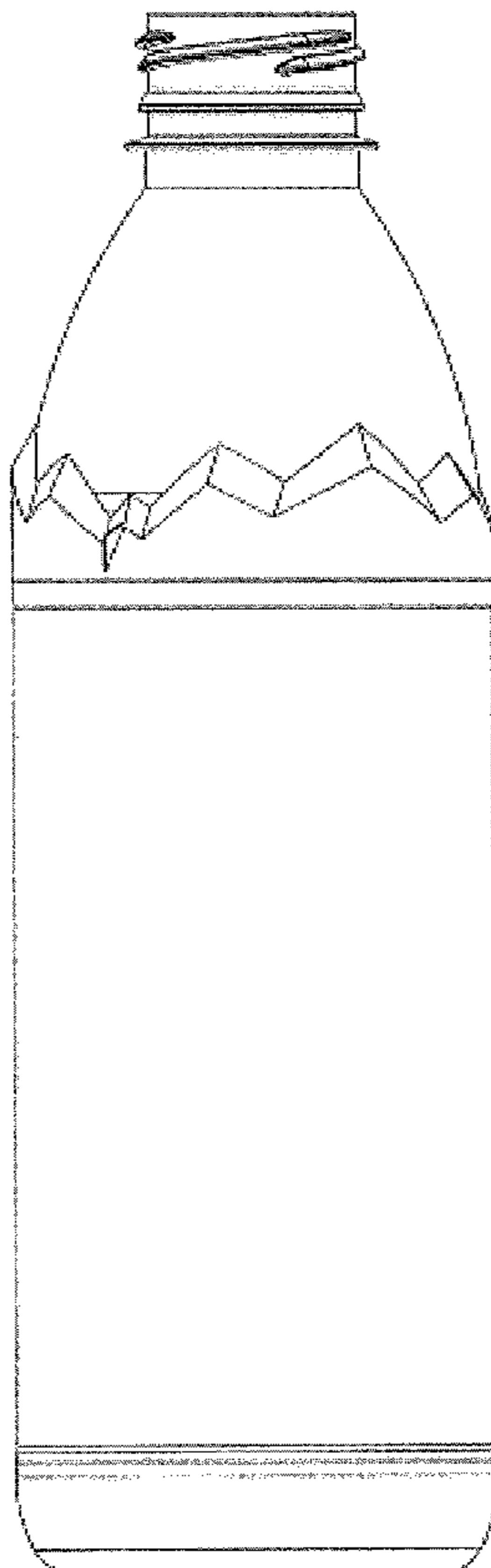

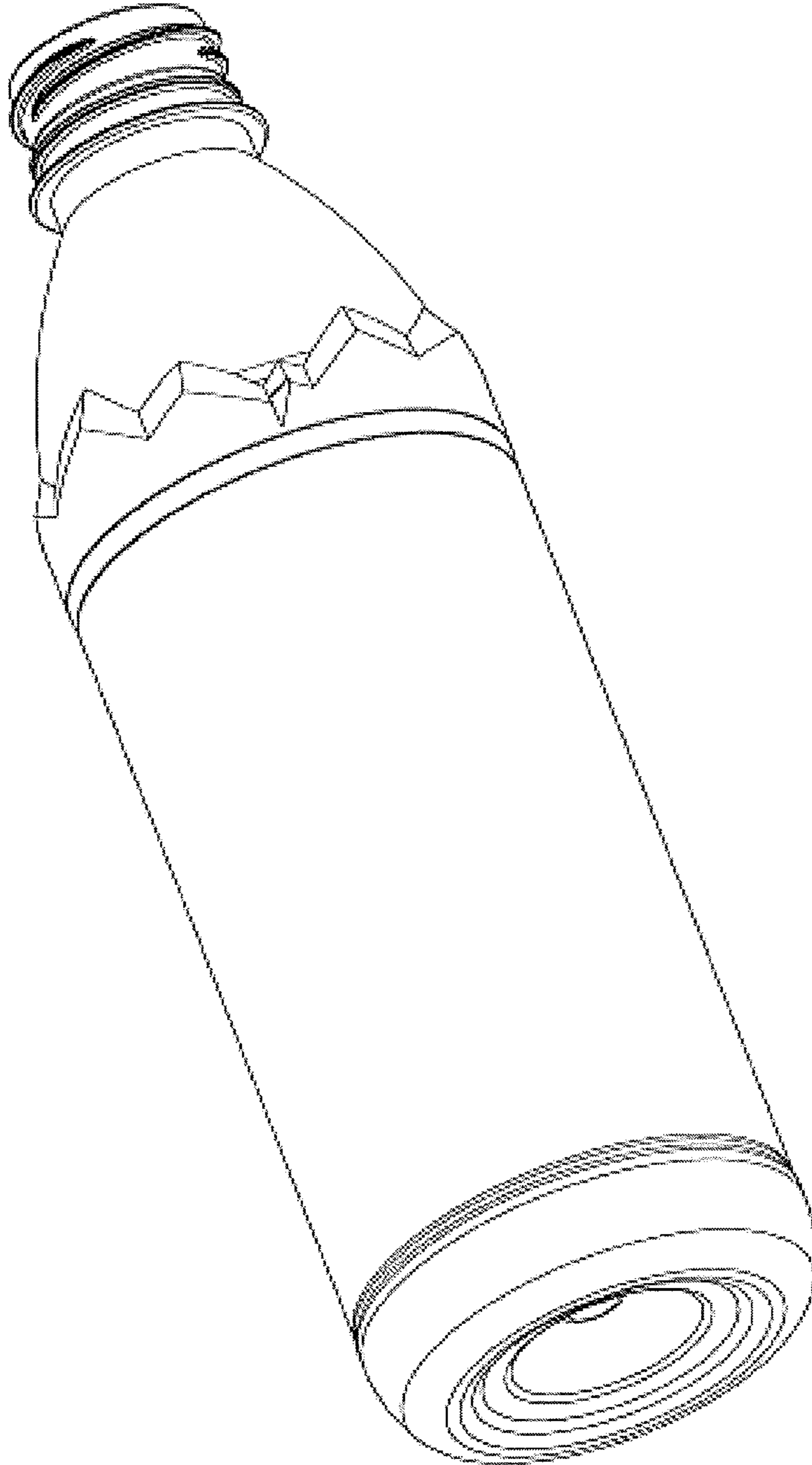

Fig. 1

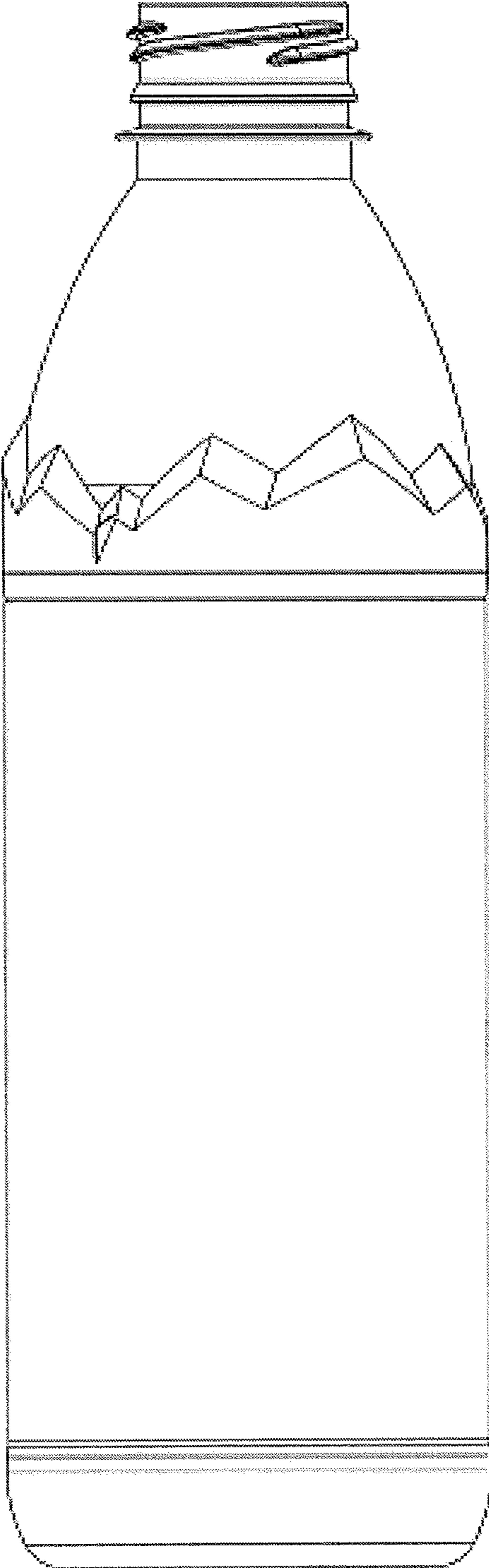

Fig. 2

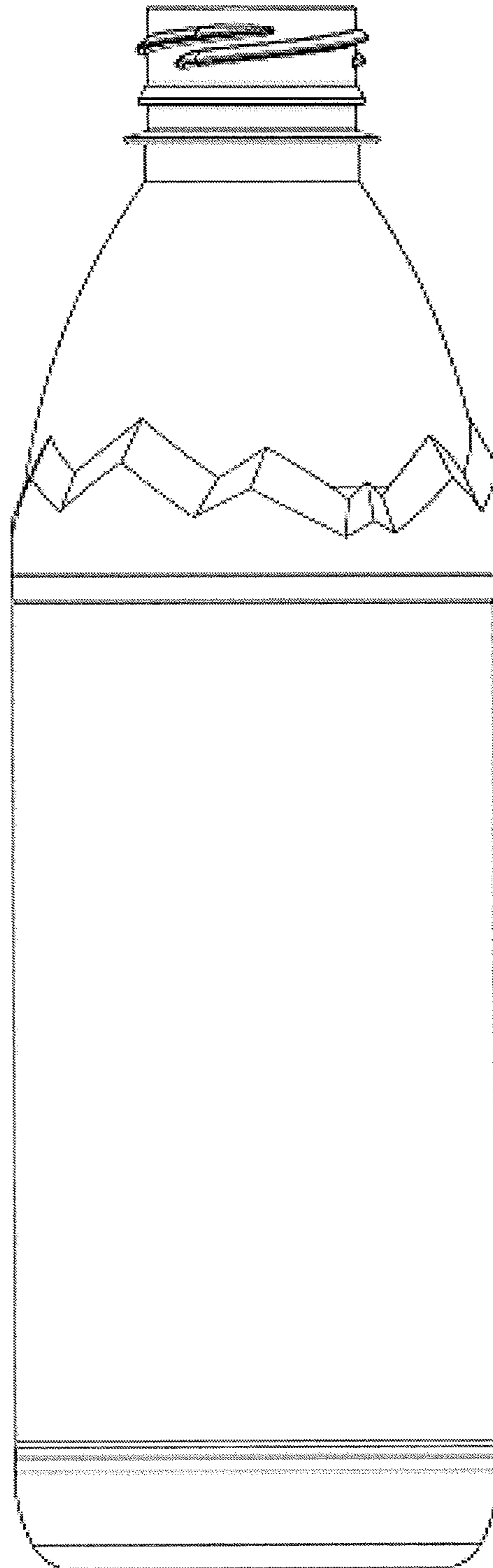

Fig. 3

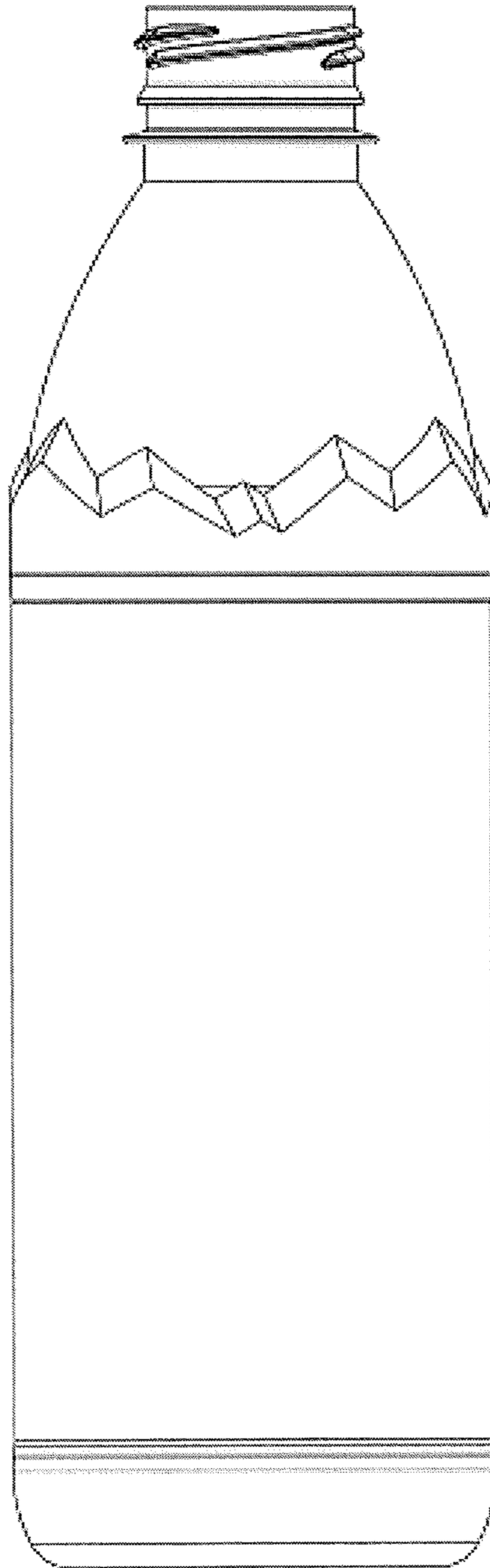

Fig. 4

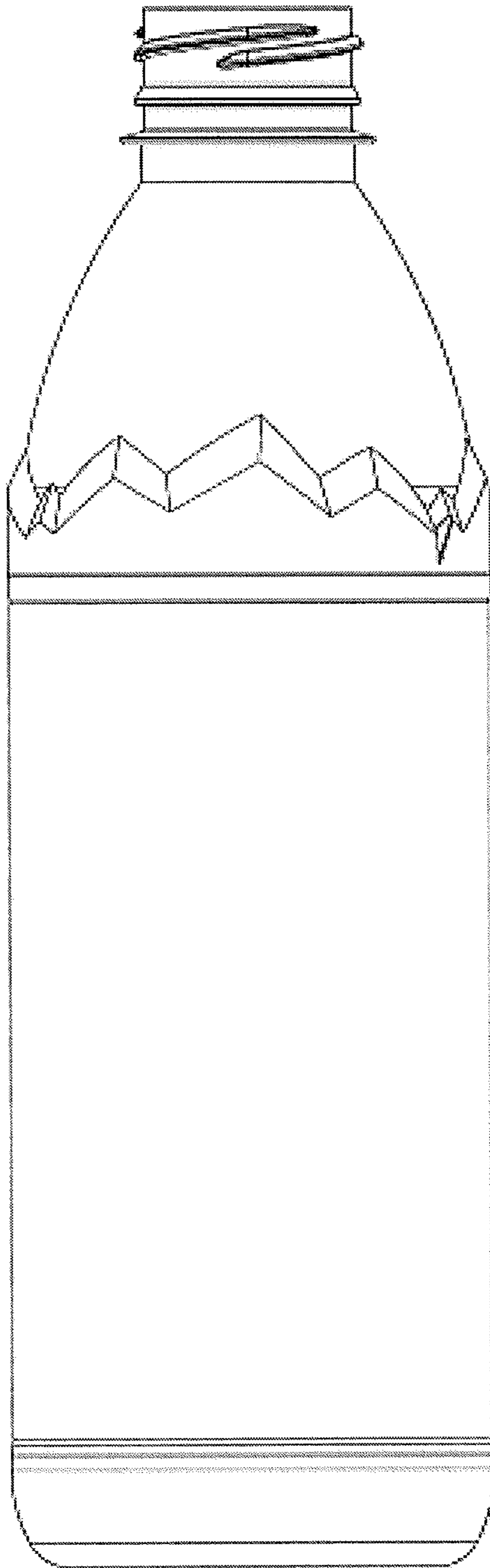

Fig. 5

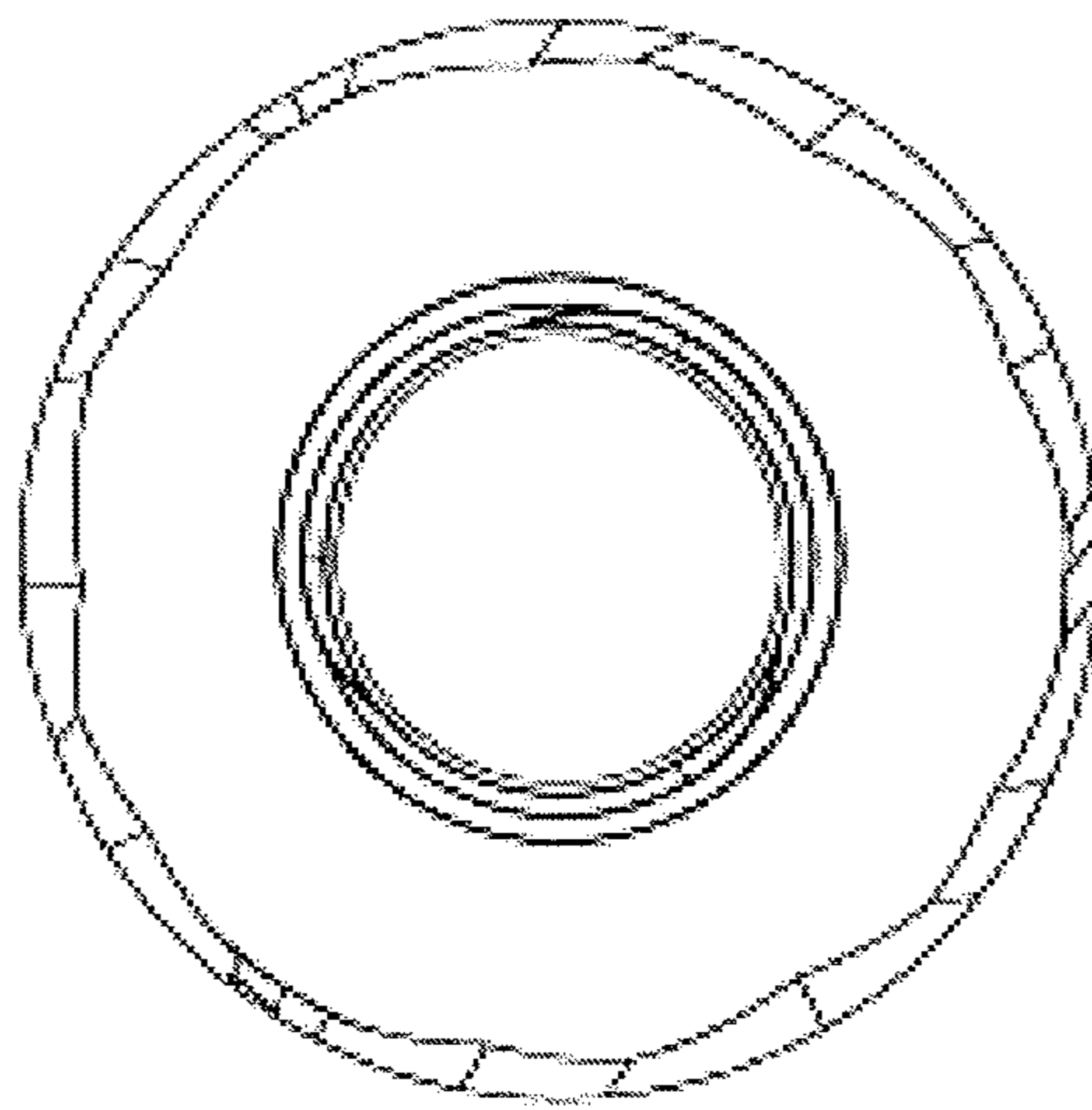

Fig. 6

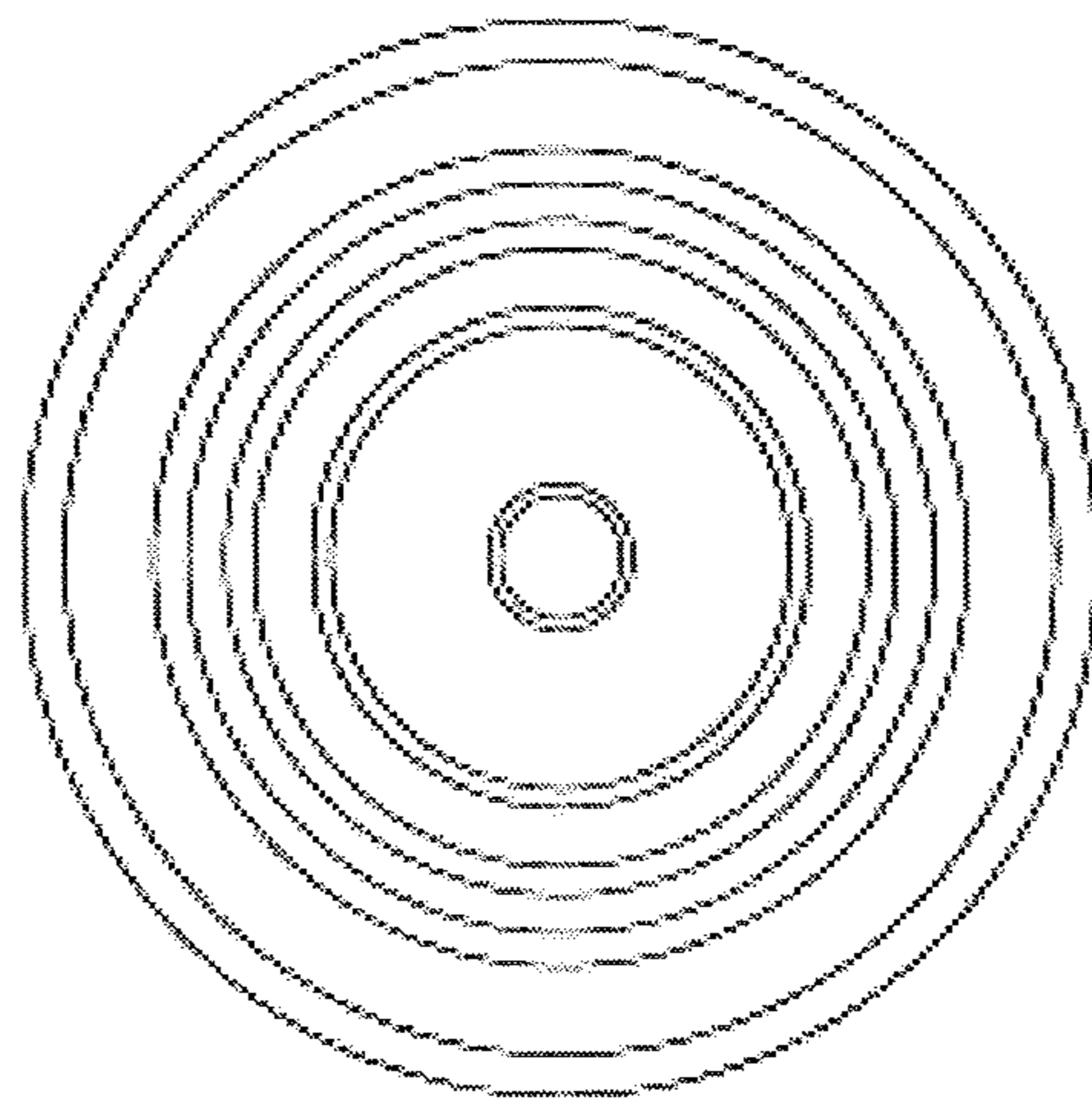

Fig. 7