



US00D710672S

(12) **United States Design Patent**  
**Roberts, III**

(10) **Patent No.:** **US D710,672 S**

(45) **Date of Patent:** **\*\* Aug. 12, 2014**

(54) **DECORATIVE LEVER**

(71) Applicant: **Ingersoll-Rand Company**, Davidson,  
NC (US)

(72) Inventor: **Rockwood T. Roberts, III**, Carmel, IN  
(US)

(73) Assignee: **Ingersoll-Rand Company**, Davidson,  
NC (US)

(\*\*) Term: **14 Years**

(21) Appl. No.: **29/456,430**

(22) Filed: **May 31, 2013**

(51) **LOC (10) Cl.** ..... **08-06**

(52) **U.S. Cl.**  
CPC ..... **E05B 85/10** (2013.01)  
USPC ..... **D8/308**

(58) **Field of Classification Search**  
CPC ..... E05B 85/10  
USPC ..... D8/300, 307, 308, DIG. 10; D23/250,  
D23/252; 16/110.1, 412, 416, DIG. 30;  
292/336.3; 74/523, 543; 70/207, 192  
See application file for complete search history.

(56) **References Cited**

**U.S. PATENT DOCUMENTS**

D197,400 S *	1/1964	Patriquin	.....	D8/302
D197,401 S *	1/1964	Maffei	.....	D8/308
D269,942 S *	8/1983	Coppola	.....	D8/308
D332,904 S *	2/1993	Plummer et al.	.....	D8/308
D356,484 S *	3/1995	Scholl	.....	D8/308
D378,231 S *	2/1997	Dubin	.....	D23/252

D380,036 S *	6/1997	Short et al.	.....	D23/252
D406,042 S *	2/1999	Klinker	.....	D8/308
D431,173 S *	9/2000	Durbin	.....	D8/308
D443,918 S *	6/2001	Lord	.....	D23/252
D457,048 S *	5/2002	Zoerner et al.	.....	D8/308
D457,049 S *	5/2002	Zoerner et al.	.....	D8/308
D467,155 S *	12/2002	Underhill et al.	.....	D8/308
D510,251 S *	10/2005	Gehry	.....	D8/308
D520,333 S *	5/2006	Gilbert	.....	D8/308
D526,556 S *	8/2006	Metivier et al.	.....	D8/308
D554,971 S *	11/2007	Flory	.....	D8/308
D577,566 S *	9/2008	Grohmann	.....	D8/308
D591,835 S *	5/2009	Williams	.....	D23/252

\* cited by examiner

*Primary Examiner* — Paula Greene

(74) *Attorney, Agent, or Firm* — Krieg DeVault LLP

(57) **CLAIM**

The ornamental design for a decorative lever, as shown and described.

**DESCRIPTION**

FIG. 1 is a front, right-side perspective view of the decorative lever.

FIG. 2 is a front view thereof.

FIG. 3 is a top view thereof.

FIG. 4 is a right-side view thereof.

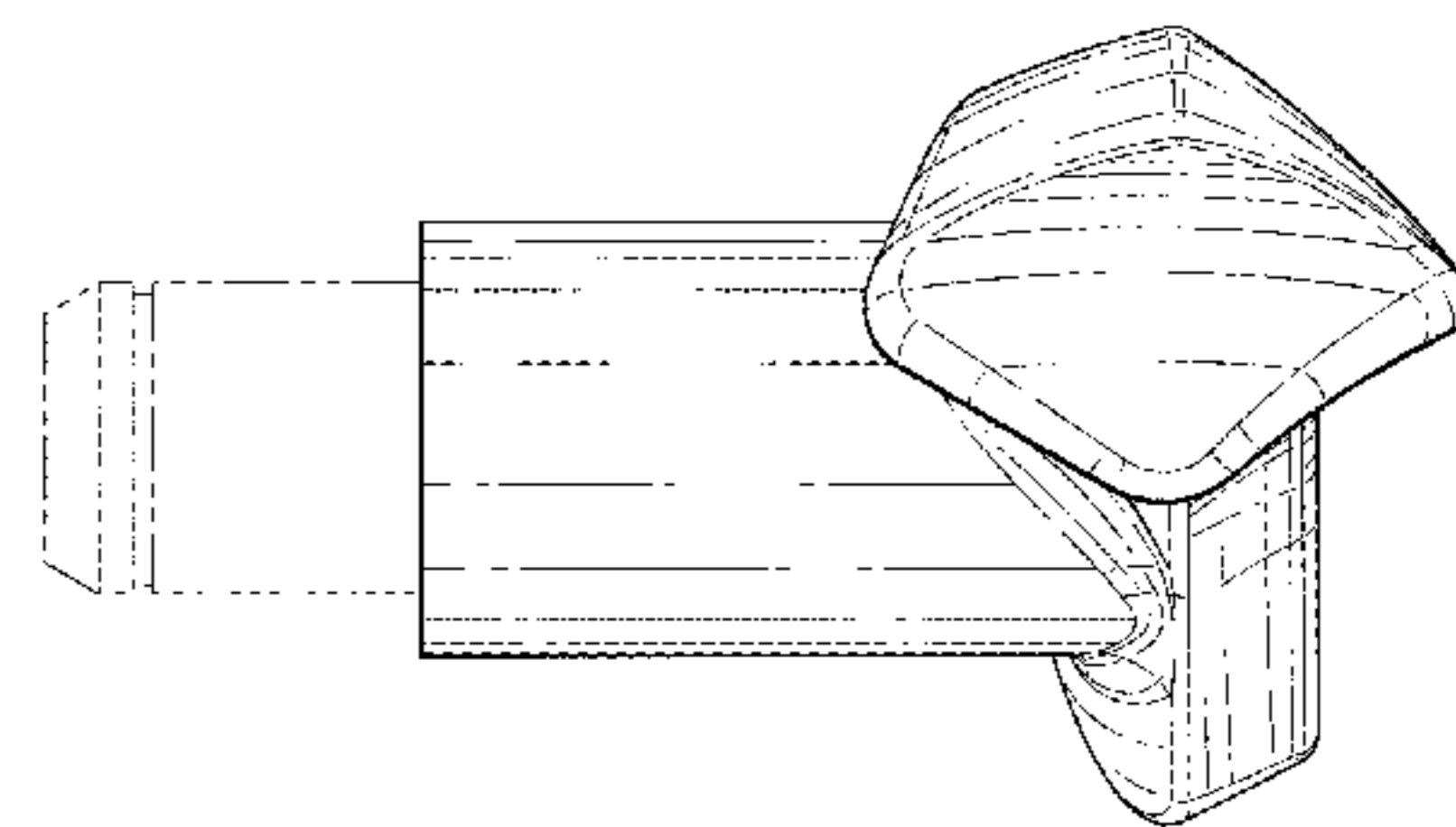
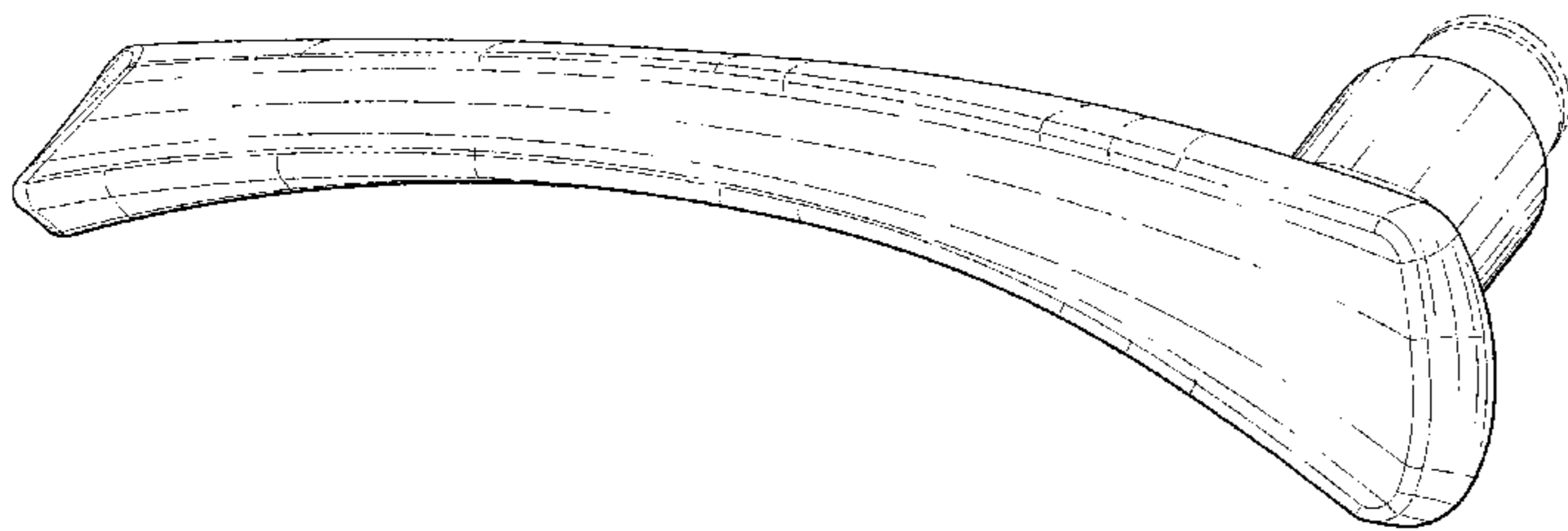
FIG. 5 is a left-side view thereof.

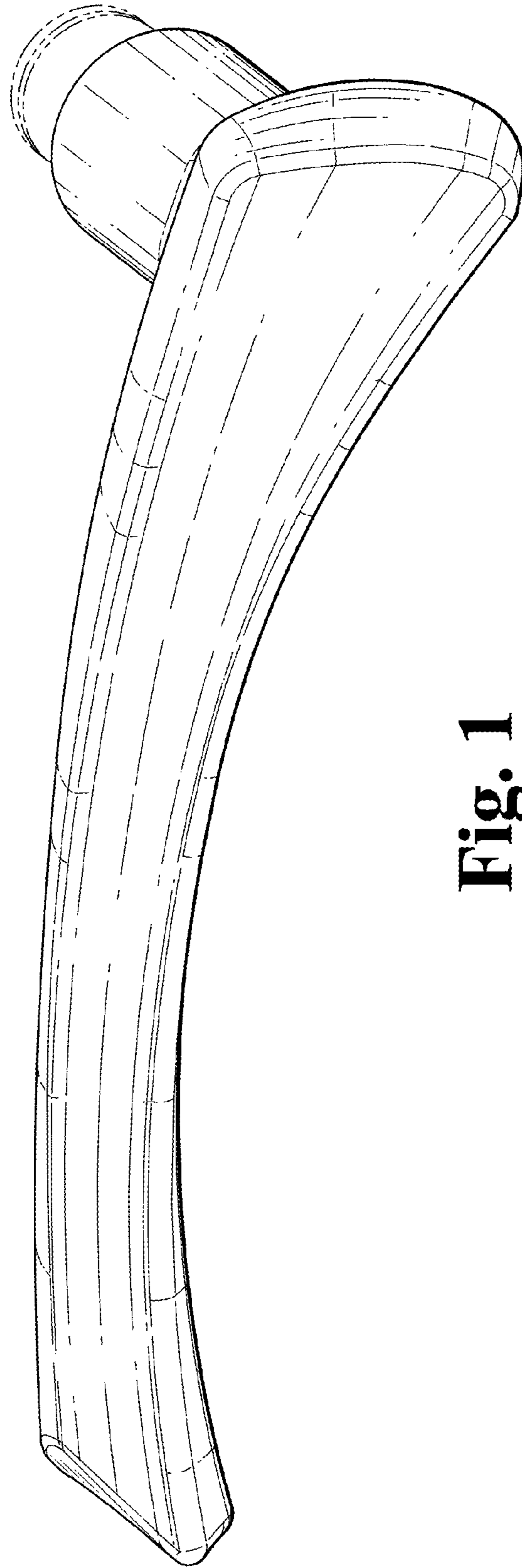
FIG. 6 is a bottom view thereof; and,

FIG. 7 is a rear view thereof.

The broken lines are for the purpose of showing illustrative attachment shanks for the decorative lever, and they form no part of the claimed design.

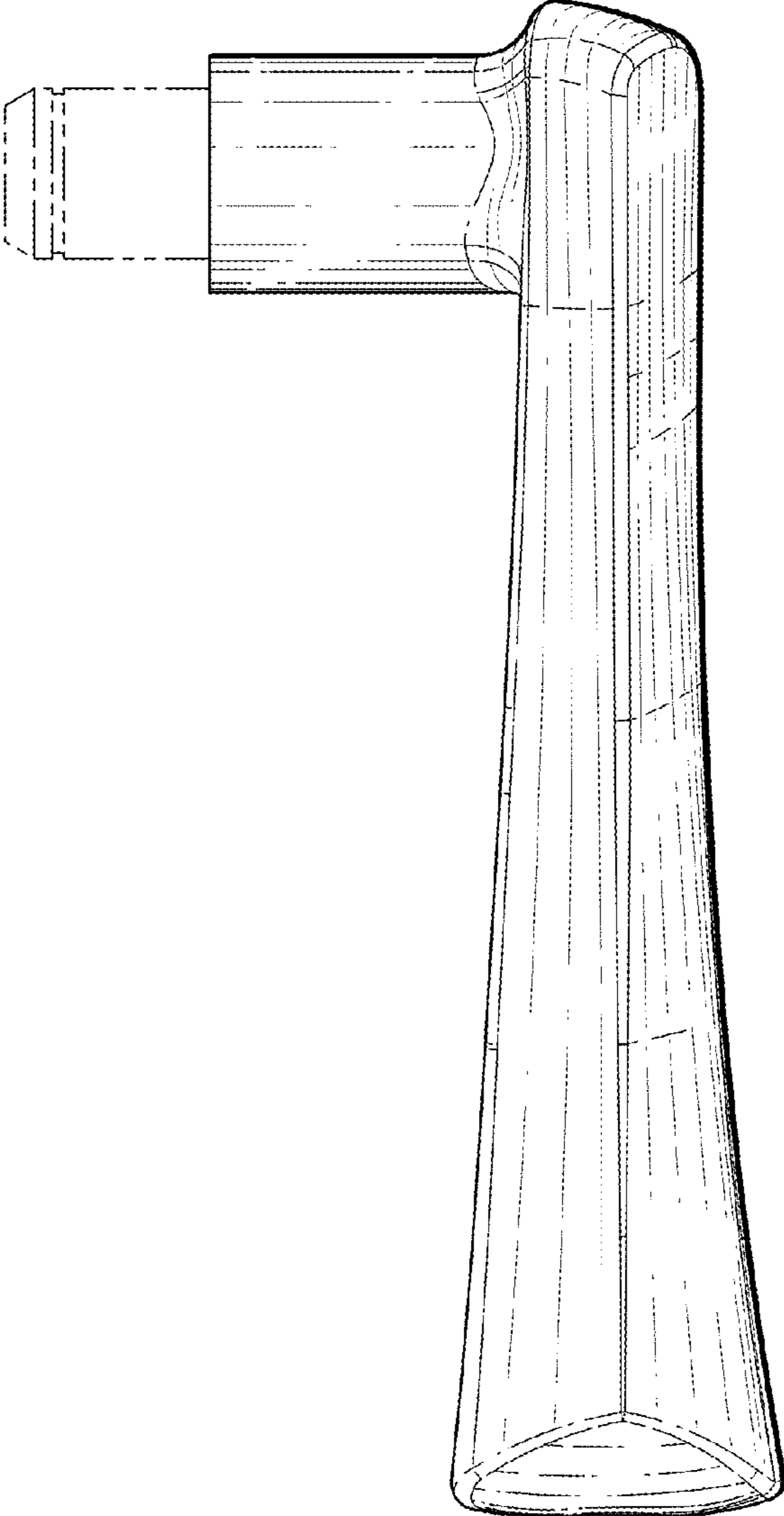
**1 Claim, 4 Drawing Sheets**



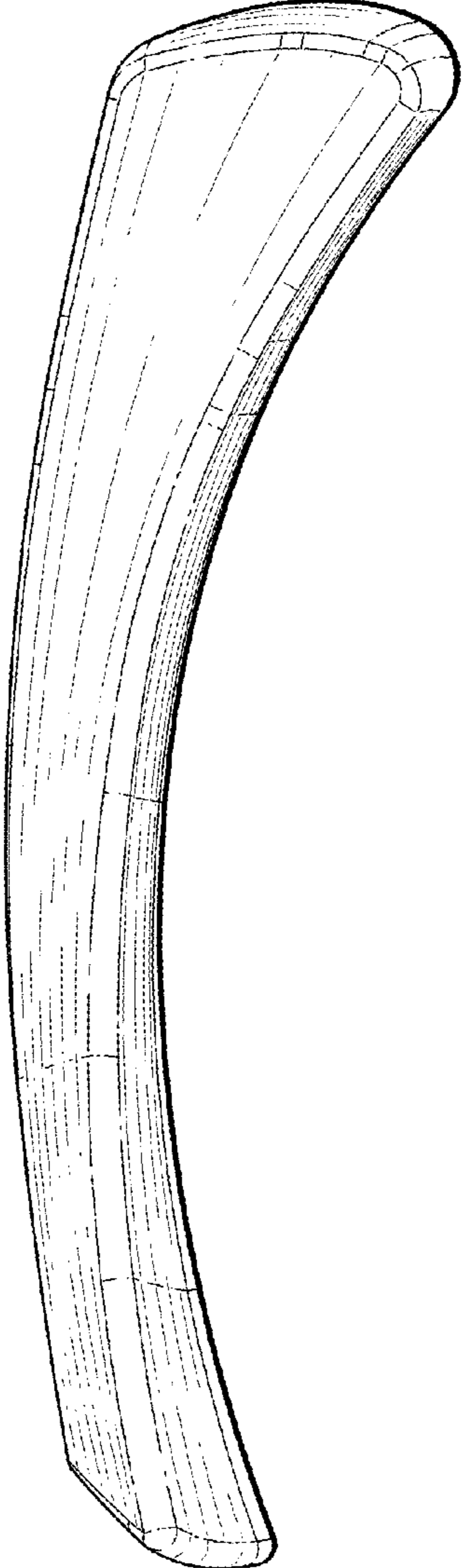


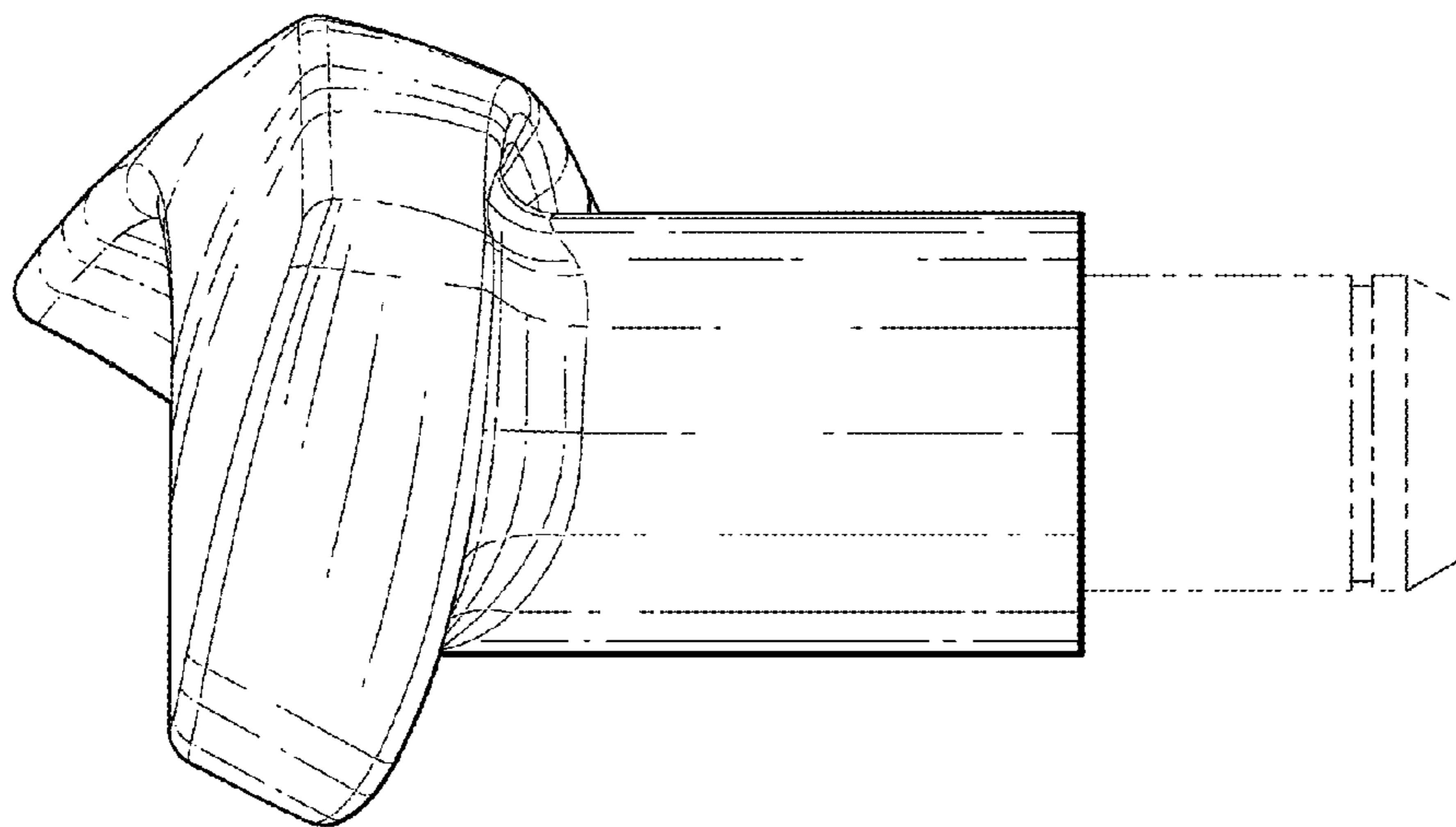
**Fig. 1**

**Fig. 3**

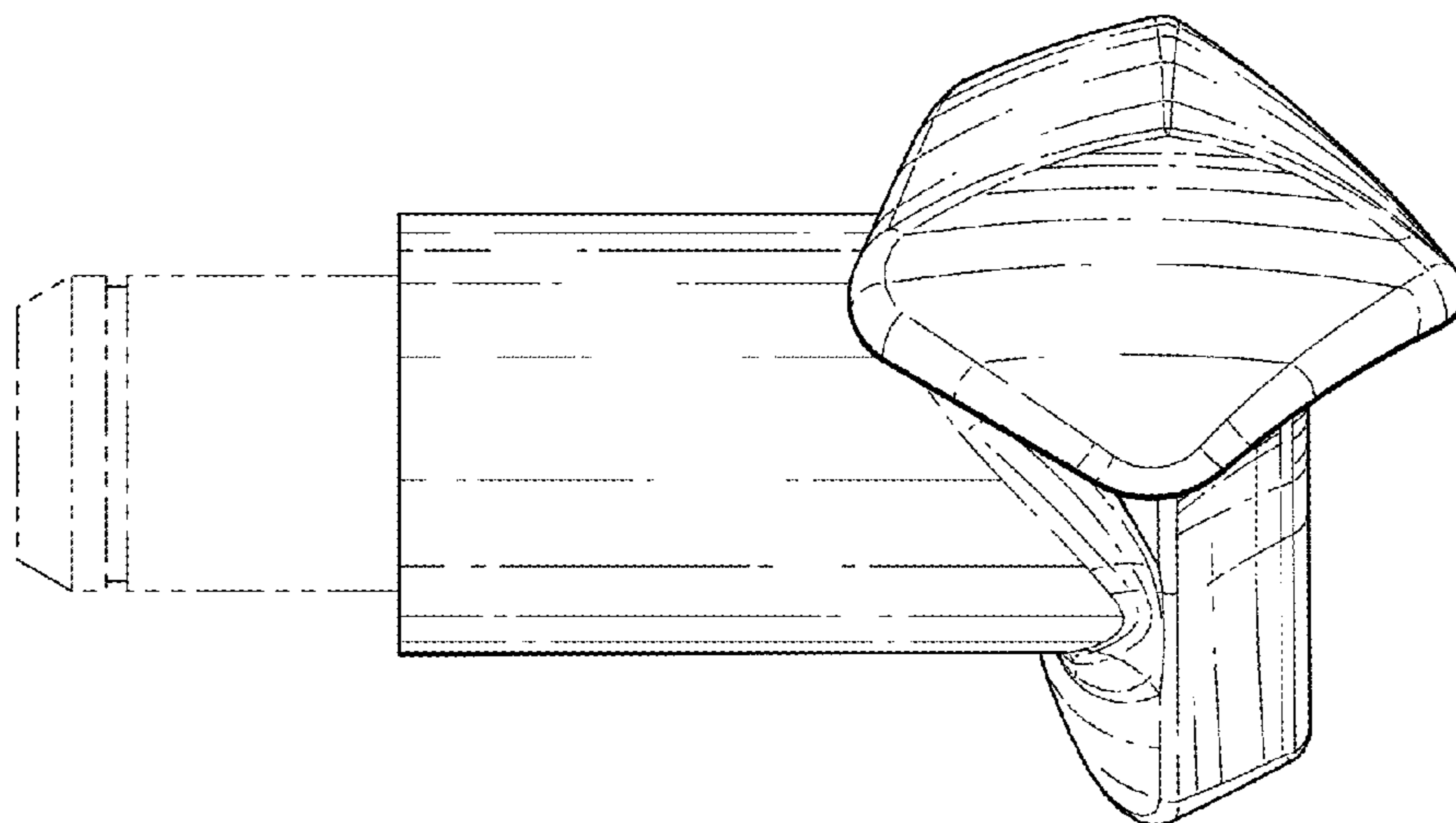


**Fig. 2**



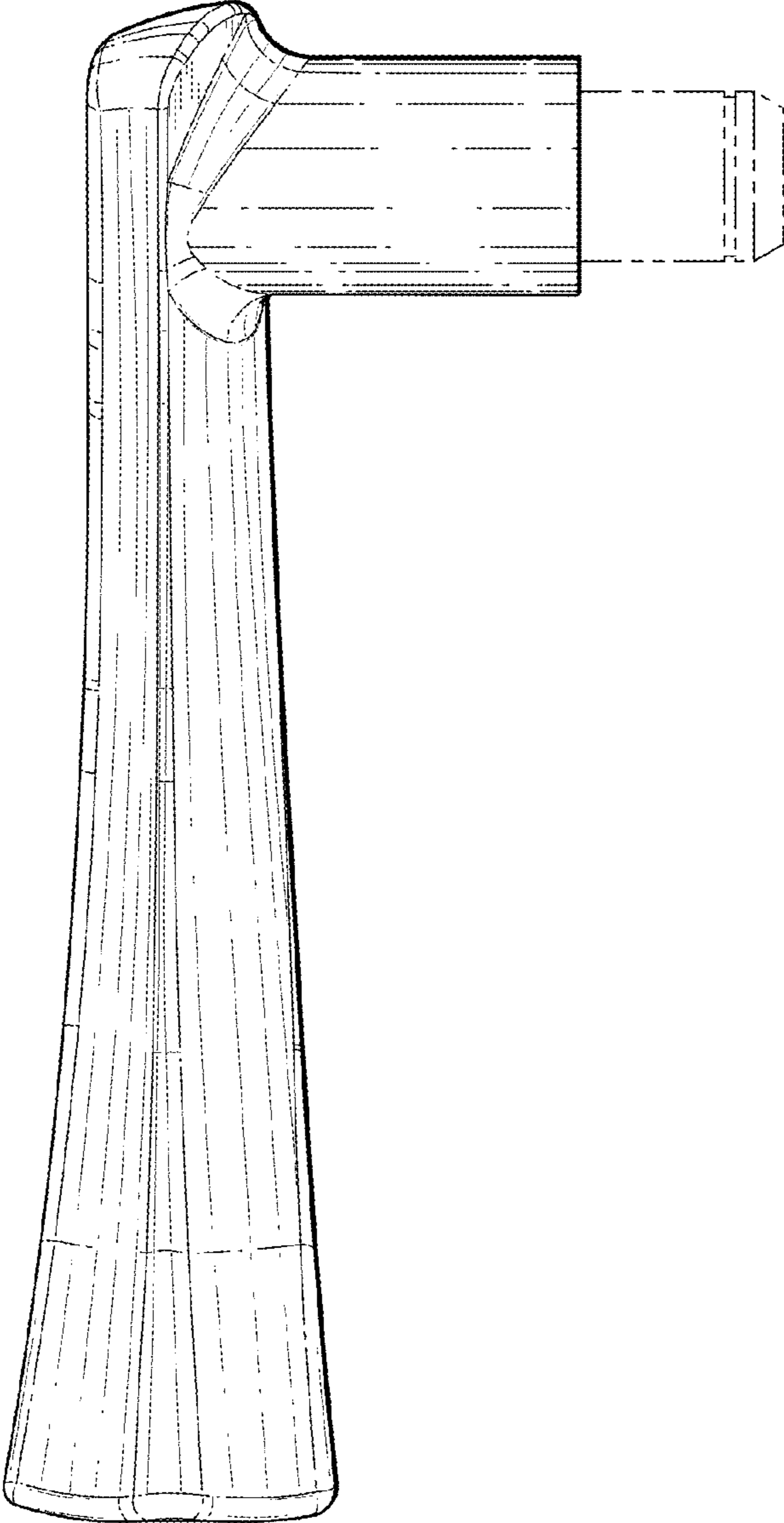


**Fig. 4**



**Fig. 5**

**Fig. 6**



**Fig. 7**

