



US00D710558S

(12) **United States Design Patent**
Mitchell et al.

(10) **Patent No.:** **US D710,558 S**

(45) **Date of Patent:** **** Aug. 5, 2014**

(54) **VACUUM CLEANER**

(71) Applicant: **Dyson Technology Limited**, Wiltshire (GB)

(72) Inventors: **Joanne Katy Mitchell**, Malmesbury (GB); **Paul Dawson**, Malmesbury (GB); **James Dyson**, Malmesbury (GB); **Peter David Gammack**, Malmesbury (GB)

(73) Assignee: **Dyson Technology Limited**, Malmesbury, Wiltshire (GB)

(**) Term: **14 Years**

(21) Appl. No.: **29/450,791**

(22) Filed: **Mar. 22, 2013**

(30) **Foreign Application Priority Data**

Sep. 24, 2012 (EM) 001344600-0002

(51) **LOC (10) Cl.** **15-05**

(52) **U.S. Cl.**
USPC **D32/21**

(58) **Field of Classification Search**
USPC D32/21, 23, 31; 15/319.353, 320, 339, 15/340.1, 383; 180/6.2; 318/568.12
See application file for complete search history.

(56) **References Cited**

U.S. PATENT DOCUMENTS

D527,854	S *	9/2006	Marzynski	D32/21
D548,411	S *	8/2007	Schroter	D32/21
D548,902	S *	8/2007	Chun et al.	D32/21
D556,961	S *	12/2007	Swyst et al.	D32/21
7,441,298	B2 *	10/2008	Svensen et al.	15/49.1
D586,959	S *	2/2009	Geringer et al.	D32/21
D593,265	S *	5/2009	Carr et al.	D32/21

D596,815	S *	7/2009	Baek	D32/21
7,832,048	B2 *	11/2010	Harwig et al.	15/320
D658,341	S *	4/2012	Nam et al.	D32/21
D659,920	S *	5/2012	Lee et al.	D32/21
D661,032	S *	5/2012	Lee et al.	D32/21
D661,439	S *	6/2012	Lee et al.	D32/21
D661,440	S *	6/2012	Lee et al.	D32/21
D665,547	S *	8/2012	Nam et al.	D32/21
D669,235	S *	10/2012	Bassett et al.	D32/21
D670,877	S *	11/2012	Geringer et al.	D32/21
8,370,985	B2 *	2/2013	Schnittman et al.	15/41.1
8,438,695	B2 *	5/2013	Gilbert et al.	15/319
D690,478	S *	9/2013	Li et al.	D32/21
D691,337	S *	10/2013	Kim et al.	D32/21
8,584,307	B2 *	11/2013	Won et al.	15/319
8,627,542	B2 *	1/2014	Kim et al.	15/319
2006/0288519	A1 *	12/2006	Jaworski et al.	15/340.1
2007/0266508	A1 *	11/2007	Jones et al.	15/49.1
2011/0191976	A1 *	8/2011	Yan	15/319
2012/0023699	A1 *	2/2012	Shim et al.	15/319

(Continued)

Primary Examiner — Ruth McInroy

(74) *Attorney, Agent, or Firm* — Morrison & Foerster LLP

(57) **CLAIM**

We claim the ornamental design for a vacuum cleaner, as shown and described.

DESCRIPTION

FIG. 1 is a perspective view of a vacuum cleaner showing our new design;

FIG. 2 is a top view thereof;

FIG. 3 is a front view thereof;

FIG. 4 is a side view thereof;

FIG. 5 is a rear view thereof;

FIG. 6 is a side view of the opposite side of FIG. 4; and,

FIG. 7 is a bottom view thereof.

The details shown in broken lines form no part of the claimed design.

1 Claim, 7 Drawing Sheets

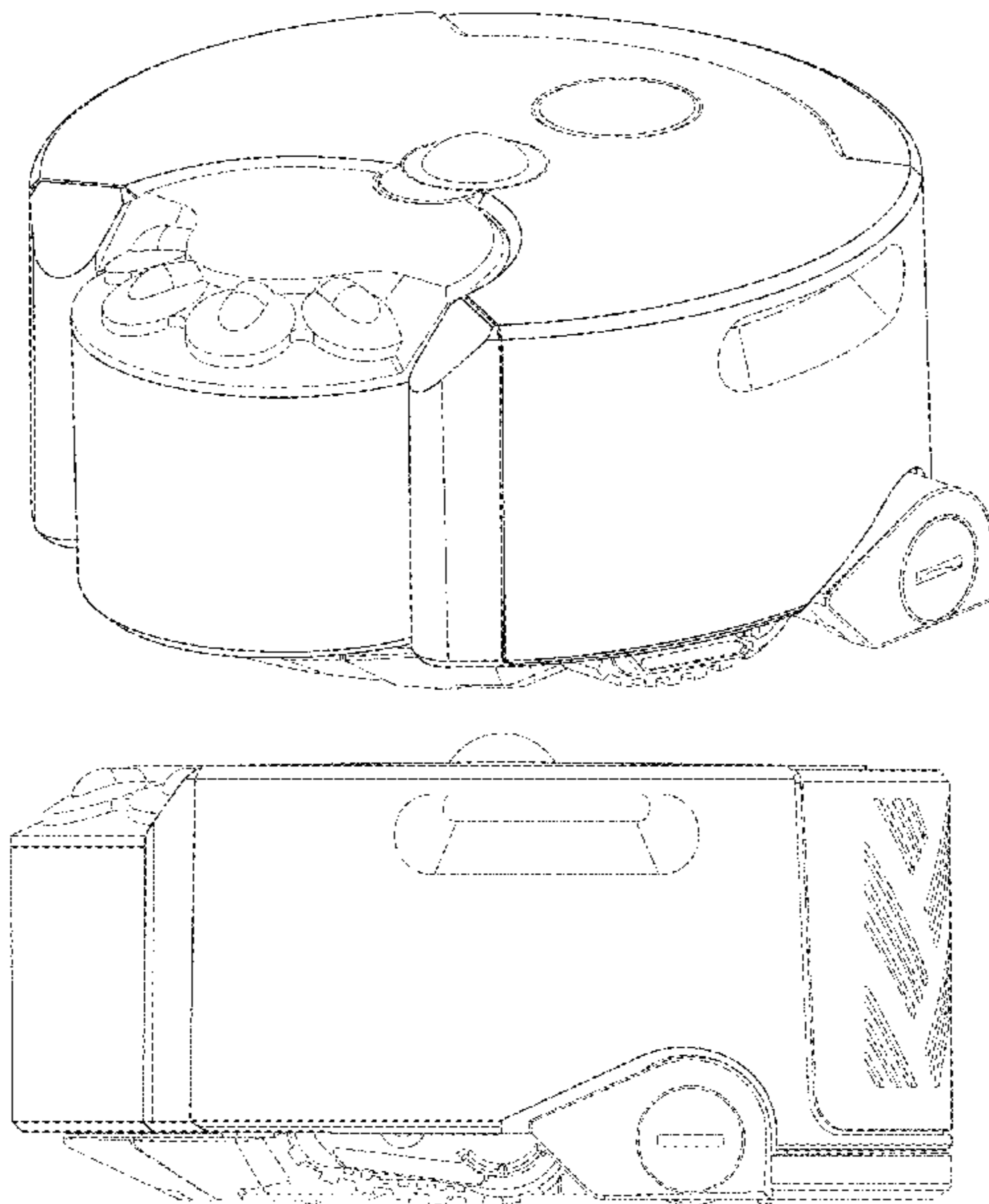

(56)

References Cited

U.S. PATENT DOCUMENTS

2012/0047676 A1* 3/2012 Jung et al. 15/319
2012/0084934 A1* 4/2012 Li 15/319
2012/0317744 A1* 12/2012 Gilbert et al. 15/319
2012/0317745 A1* 12/2012 Jung et al. 15/319
2013/0025085 A1* 1/2013 Kim et al. 15/319

2013/0061417 A1* 3/2013 Vanderstegen-Drake
et al. 15/319
2013/0086760 A1* 4/2013 Han et al. 15/49.1
2013/0152332 A1* 6/2013 Jang 15/319
2013/0305484 A1* 11/2013 Dyson et al. 15/353
2013/0340201 A1* 12/2013 Jang et al. 15/319

* cited by examiner

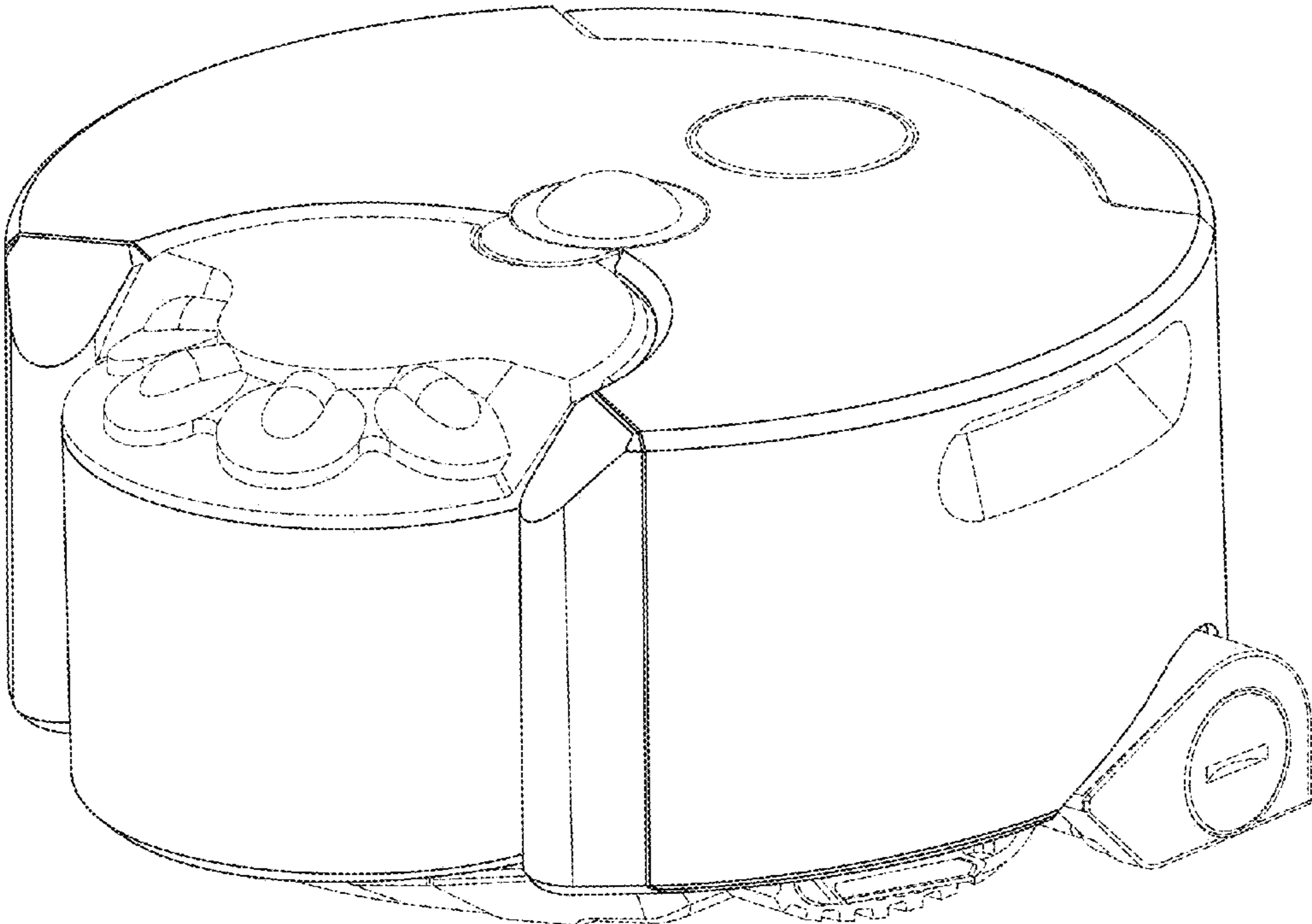

FIG. 1

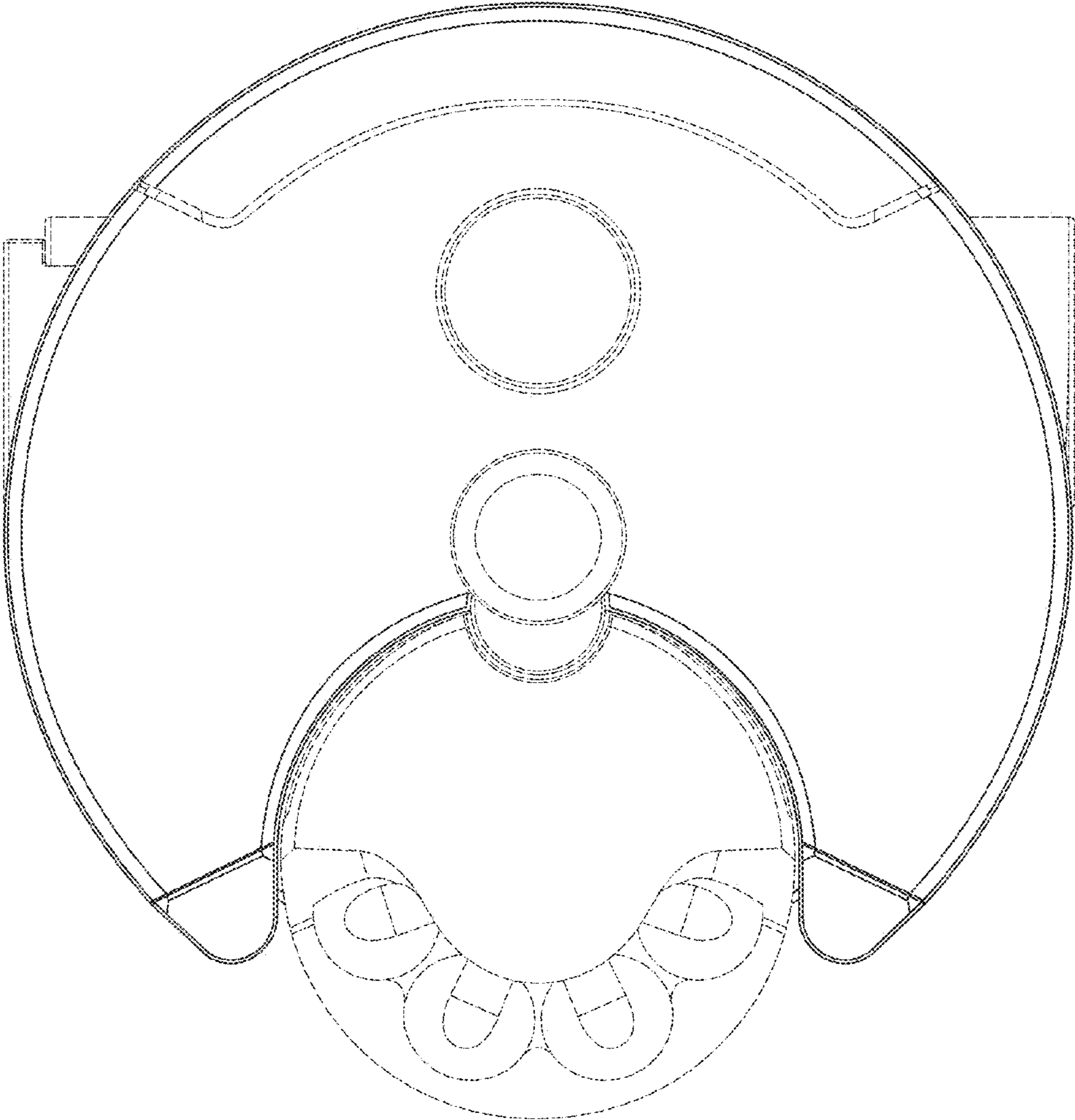

FIG. 2

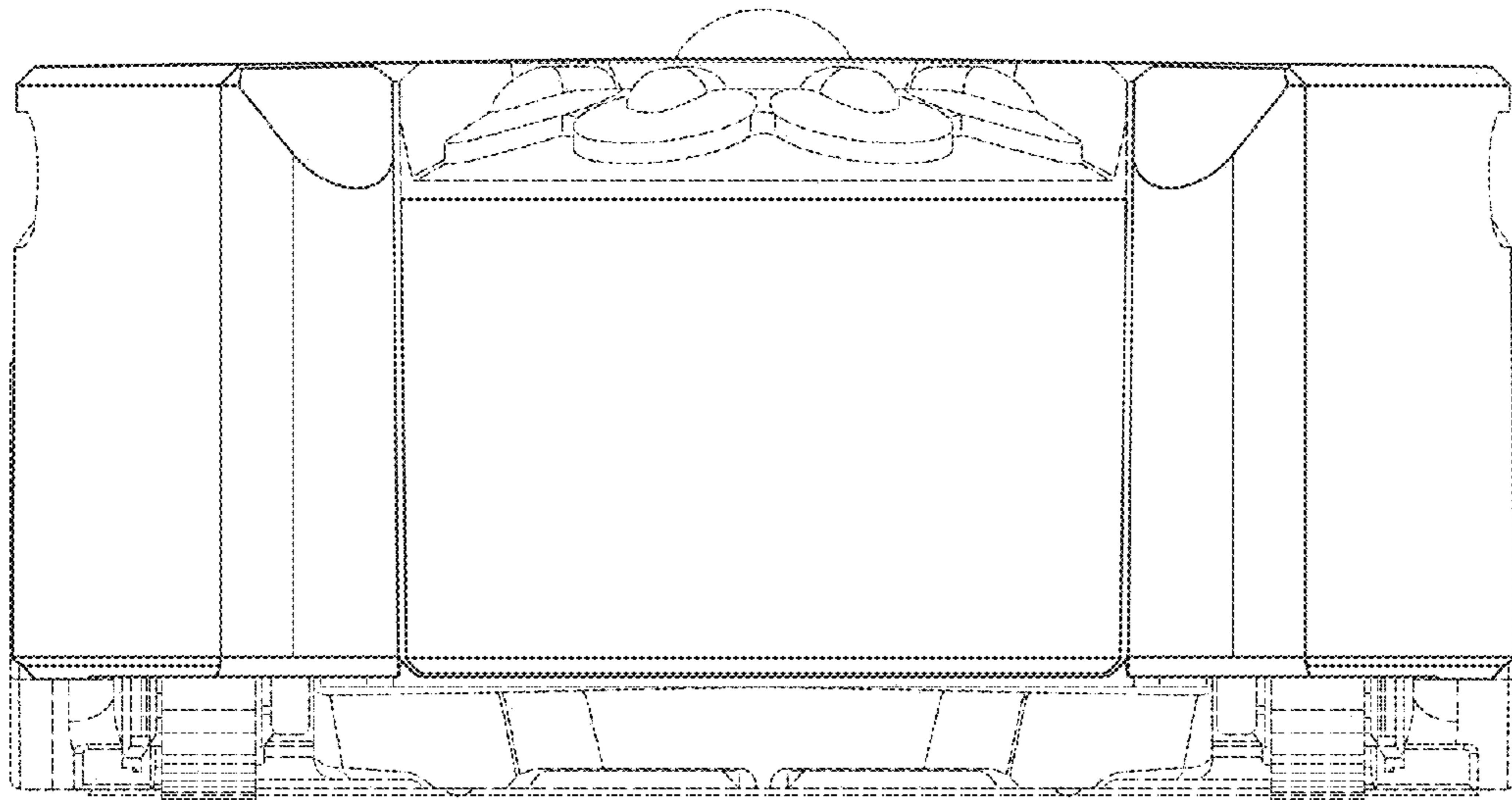

FIG. 3

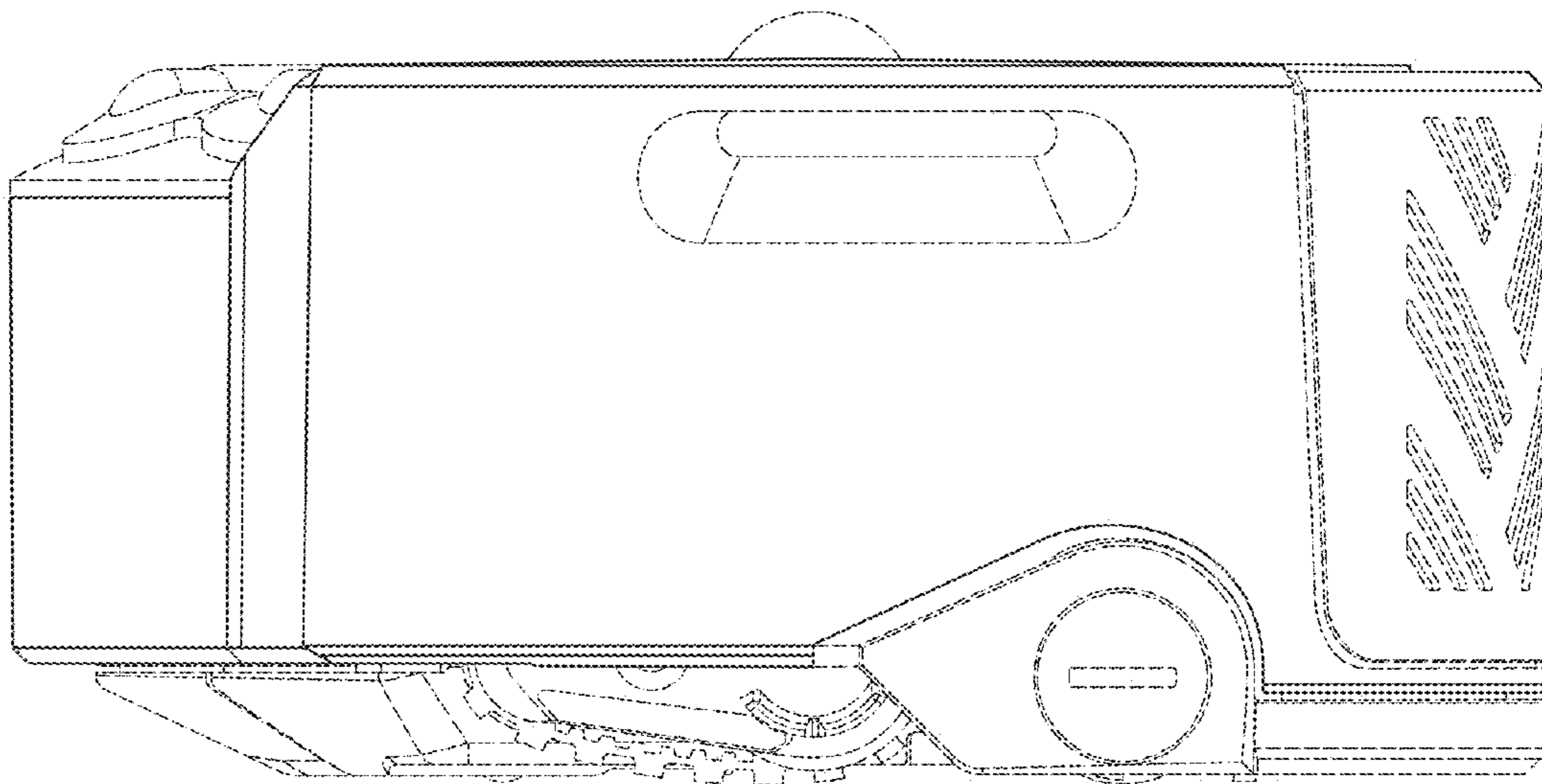

FIG. 4

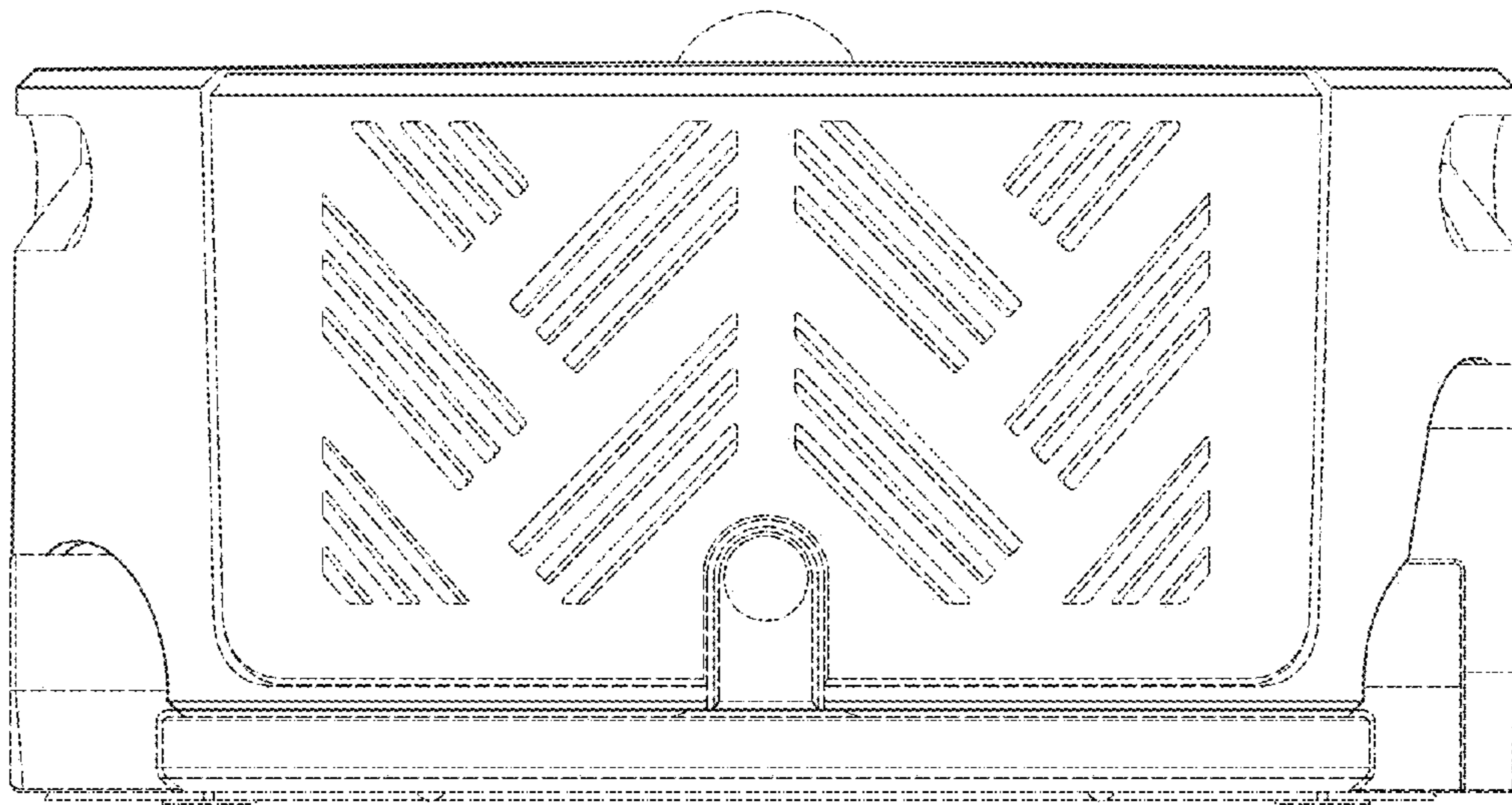

FIG. 5

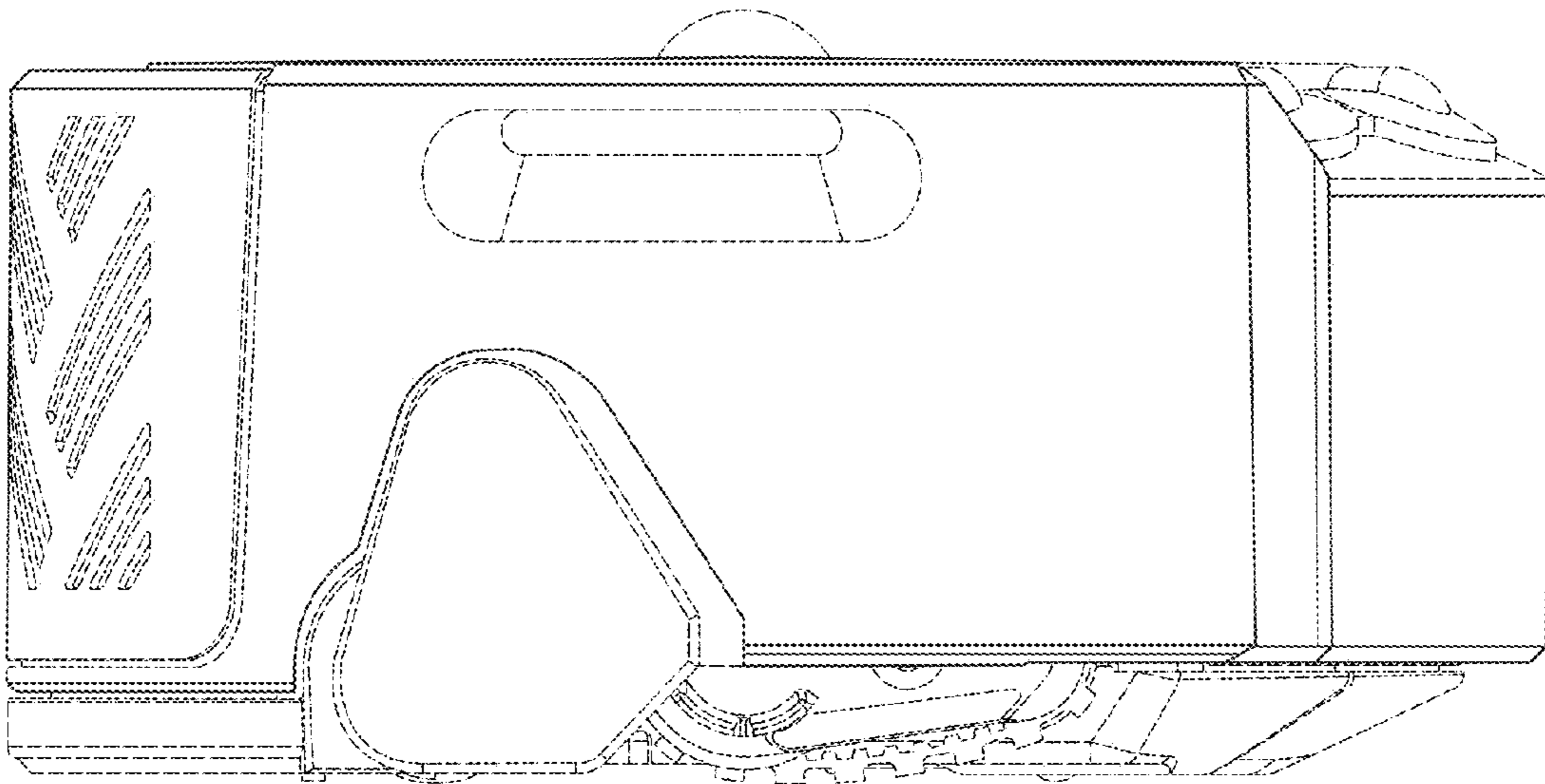

FIG. 6

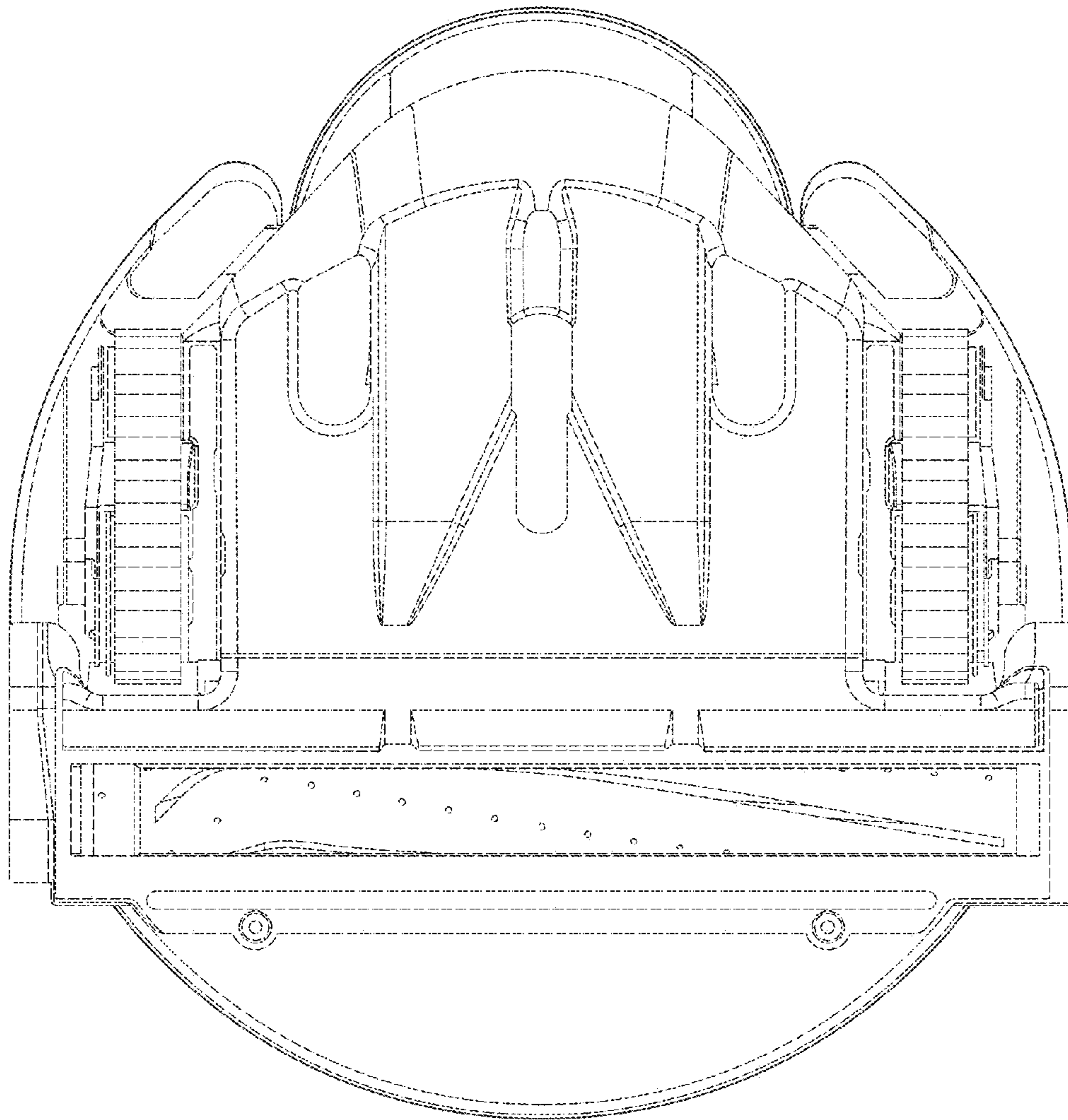

FIG. 7

UNITED STATES PATENT AND TRADEMARK OFFICE
CERTIFICATE OF CORRECTION

PATENT NO. : D710,558 S
APPLICATION NO. : 29/450791
DATED : August 5, 2014
INVENTOR(S) : Joanne Katy Mitchell et al.

Page 1 of 9

It is certified that error appears in the above-identified patent and that said Letters Patent is hereby corrected as shown below:

The title page showing the illustrative figure should be deleted to be replaced with the attached title page.

The drawing sheets, consisting of Figs. 1-7, should be deleted to be replaced with the drawing sheets, consisting of Figs. 1-7, as shown on the attached pages.

Signed and Sealed this
Third Day of March, 2015



Michelle K. Lee
Deputy Director of the United States Patent and Trademark Office

(12) **United States Design Patent**
Mitchell et al.

(10) **Patent No.:** **US D710,558 S**
(45) Date of Patent: **** Aug. 5, 2014**

(54) **VACUUM CLEANER**

(71) Applicant: **Dyson Technology Limited, Wiltshire (GB)**

(72) Inventors: **Joanne Katy Mitchell, Malmesbury (GB); Paul Dawson, Malmesbury (GB); James Dyson, Malmesbury (GB); Peter David Gammack, Malmesbury (GB)**

(73) Assignee: **Dyson Technology Limited, Malmesbury, Wiltshire (GB)**

(**) Term: **14 Years**

(21) Appl. No.: **29/450,791**

(22) Filed: **Mar. 22, 2013**

(30) **Foreign Application Priority Data**

Sep. 24, 2012 (EM) 001344600-0002

(51) **LOC (10) Cl.** **15-05**

(52) **U.S. Cl.** **D32/21**
 USPC

(58) **Field of Classification Search**
 USPC D32/21, 23, 31; 15/319.353, 320, 339,
 15/340.1, 383, 180/6.2; 318/568.12
 See application file for complete search history.

(56) **References Cited**

U.S. PATENT DOCUMENTS

D527,854 S *	9/2006	Marzynski	D32/21
D548,411 S *	8/2007	Schroter	D32/21
D548,902 S *	8/2007	Chun et al.	D32/21
D556,961 S *	12/2007	Swyst et al.	D32/21
7,441,298 B2 *	10/2008	Svendsen et al.	15/49.1
D586,959 S *	2/2009	Geringer et al.	D32/21
D593,265 S *	5/2009	Carr et al.	D32/21

D596,815 S *	7/2009	Baek	D32/21
7,832,048 B2 *	11/2010	Harwig et al.	15/320
D658,341 S *	4/2012	Nam et al.	D32/21
D659,920 S *	5/2012	Lee et al.	D32/21
D661,032 S *	5/2012	Lee et al.	D32/21
D661,439 S *	6/2012	Lee et al.	D32/21
D661,440 S *	6/2012	Lee et al.	D32/21
D665,547 S *	8/2012	Nam et al.	D32/21
D669,235 S *	10/2012	Bassett et al.	D32/21
D670,877 S *	11/2012	Geringer et al.	D32/21
8,370,985 B2 *	2/2013	Schnitman et al.	15/41.1
8,438,695 B2 *	5/2013	Gilbert et al.	15/319
D690,478 S *	9/2013	Li et al.	D32/21
D691,337 S *	10/2013	Kun et al.	D32/21
8,584,307 B2 *	11/2013	Won et al.	15/319
8,627,542 B2 *	1/2014	Kim et al.	15/319
2006/0288519 A1 *	12/2006	Jaworski et al.	15/340.1
2007/0266508 A1 *	11/2007	Jones et al.	15/49.1
2011/0191976 A1 *	8/2011	Yan	15/319
2012/0023699 A1 *	2/2012	Shim et al.	15/319

(Continued)

Primary Examiner — Ruth McIntroy

(74) Attorney, Agent, or Firm — Morrison & Foerster LLP

(57) **CLAIM**

We claim the ornamental design for a vacuum cleaner, as shown and described.

DESCRIPTION

FIG. 1 is a perspective view of a vacuum cleaner showing our new design;
 FIG. 2 is a top view thereof;
 FIG. 3 is a front view thereof;
 FIG. 4 is a side view thereof;
 FIG. 5 is a rear view thereof;
 FIG. 6 is a side view of the opposite side of FIG. 4; and,
 FIG. 7 is a bottom view thereof.
 The details shown in broken lines form no part of the claimed design.

1 Claim, 7 Drawing Sheets

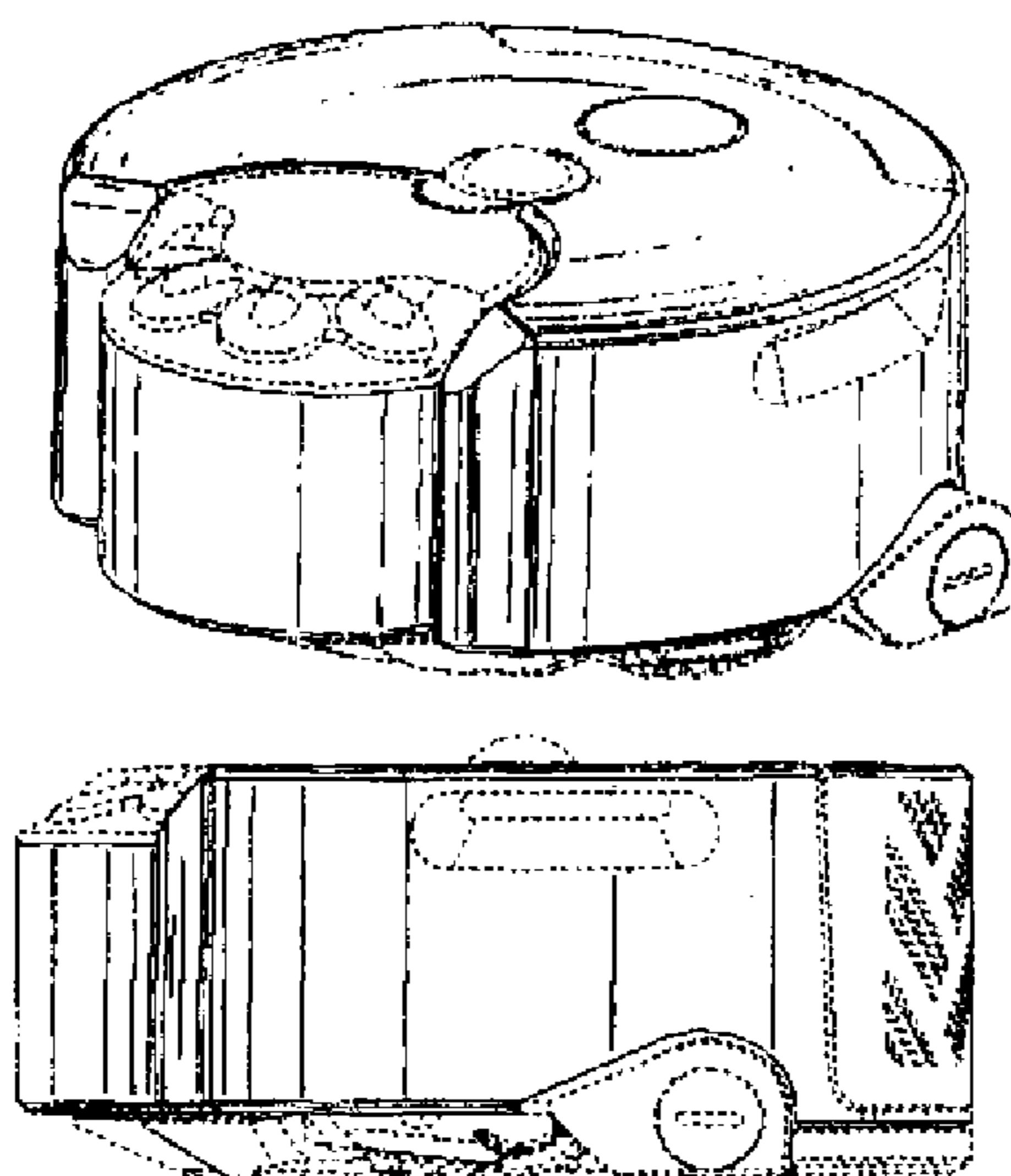

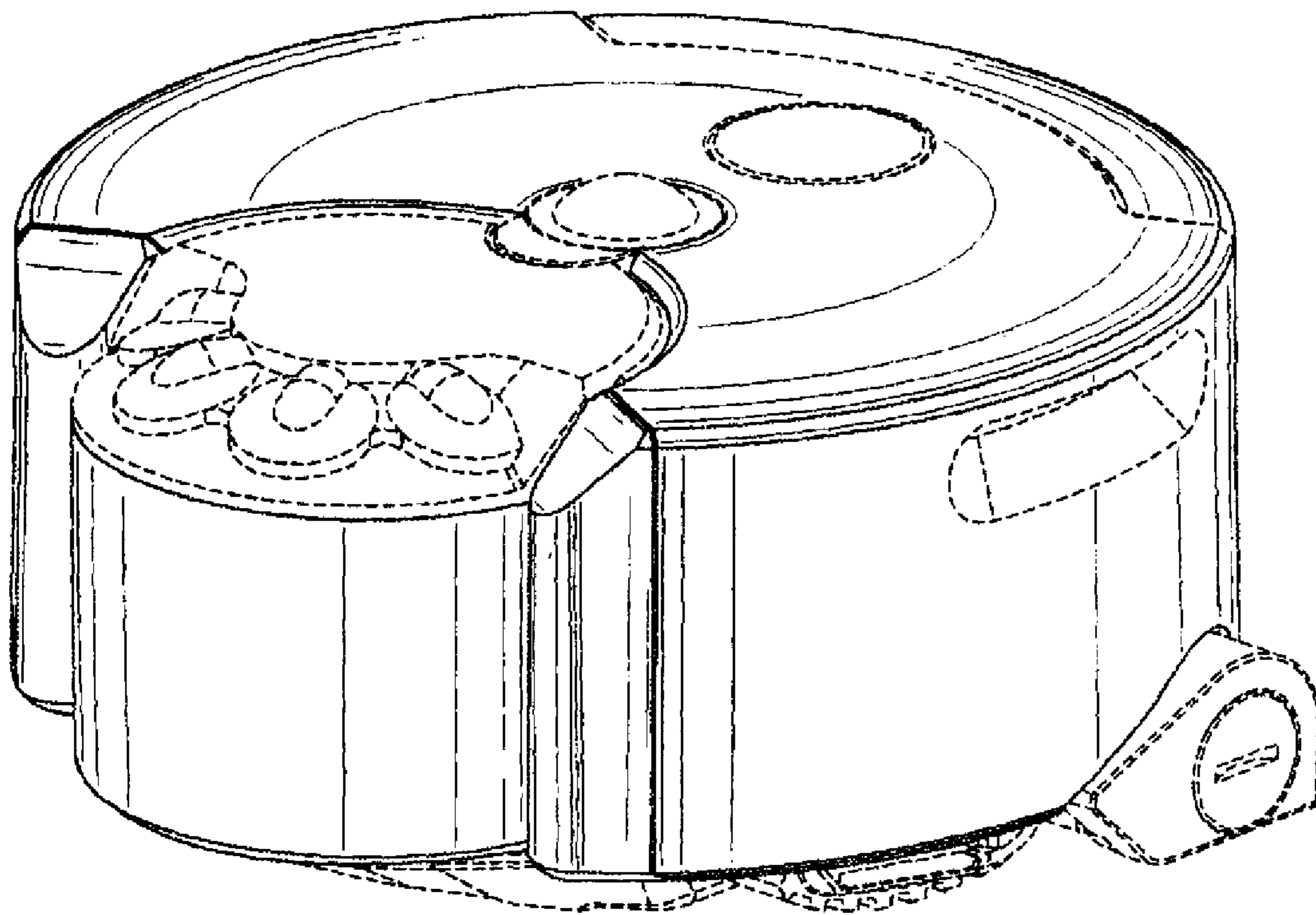

FIG. 1

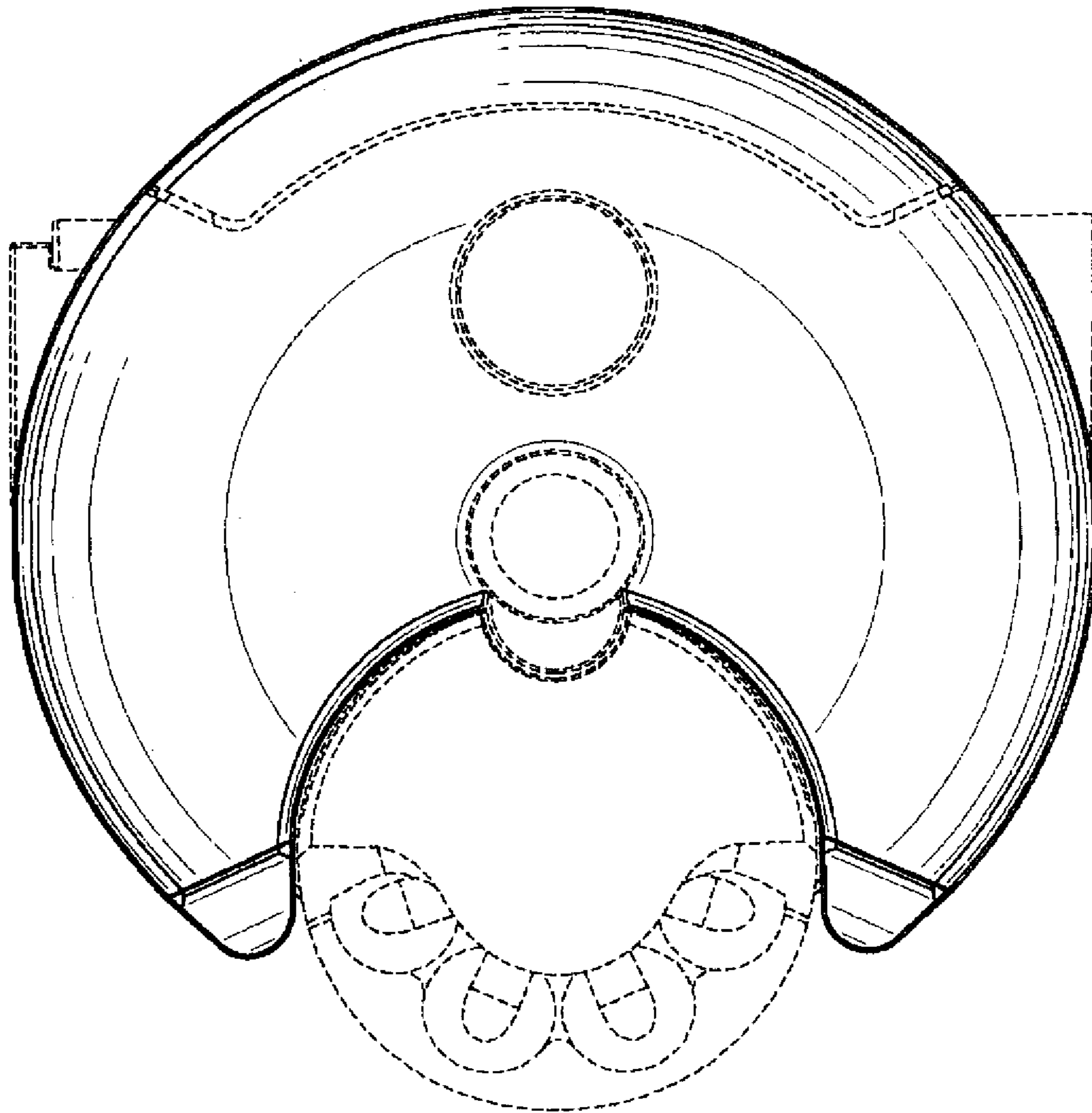

FIG. 2

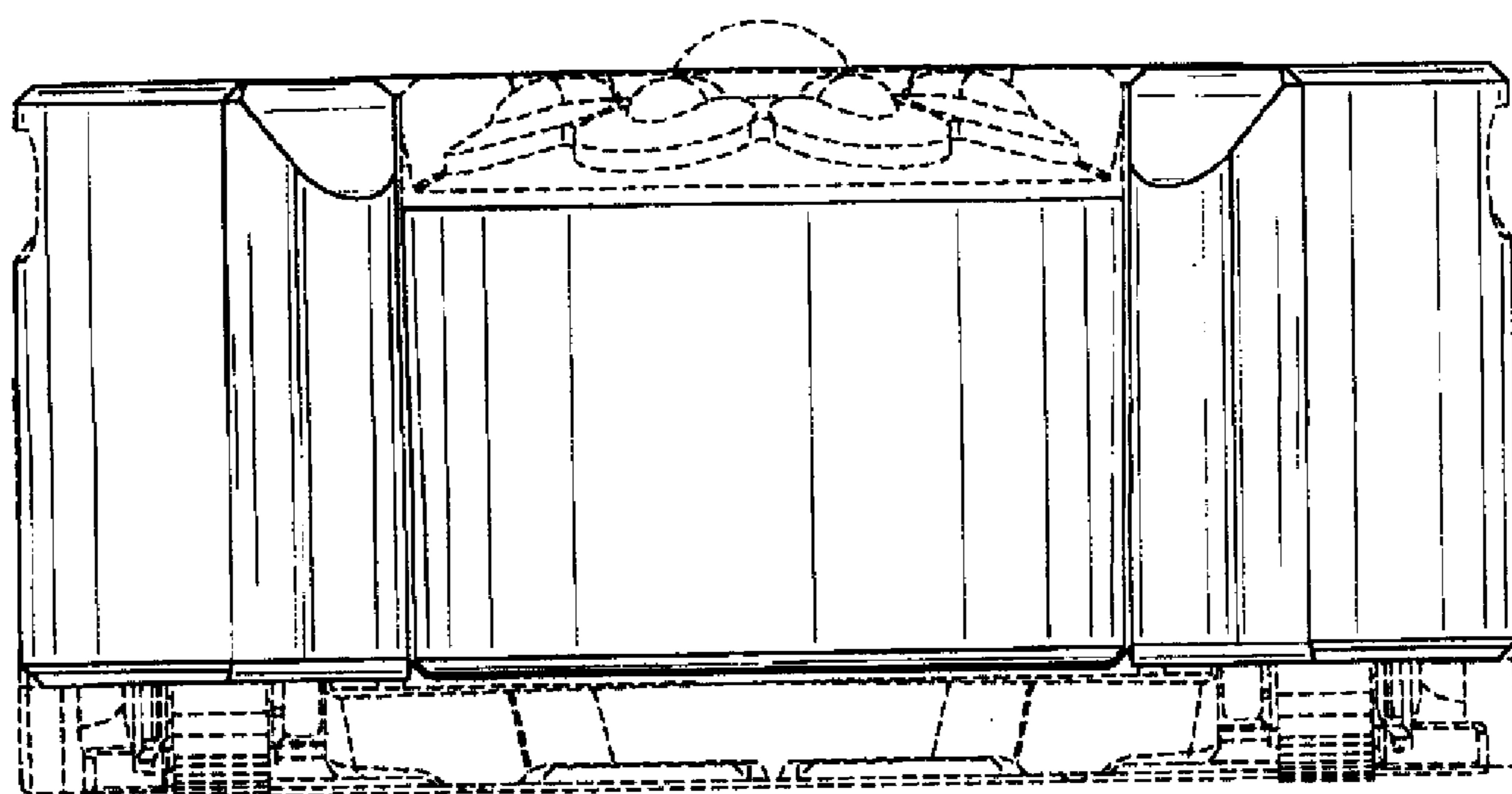

FIG. 3

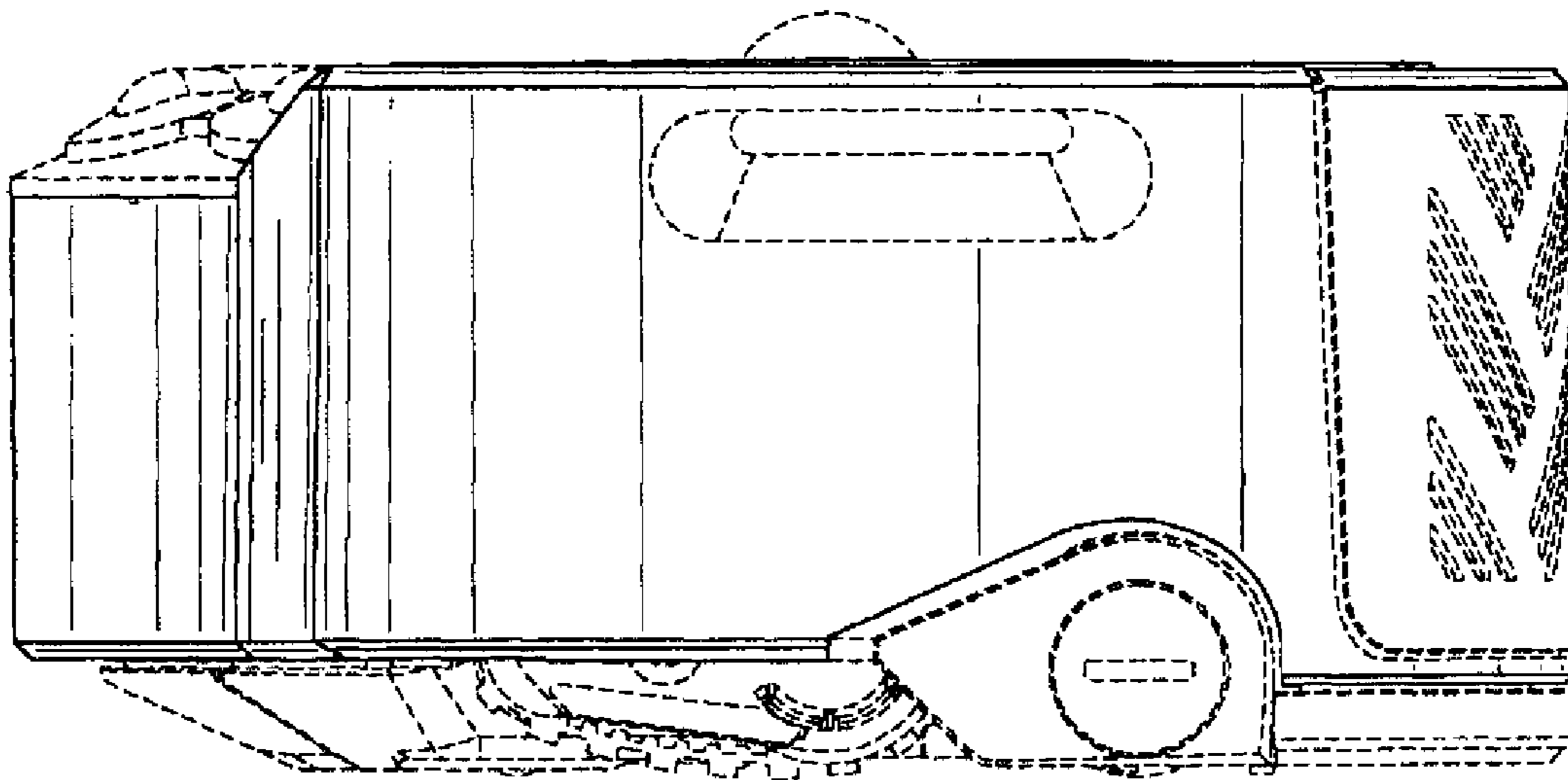

FIG. 4

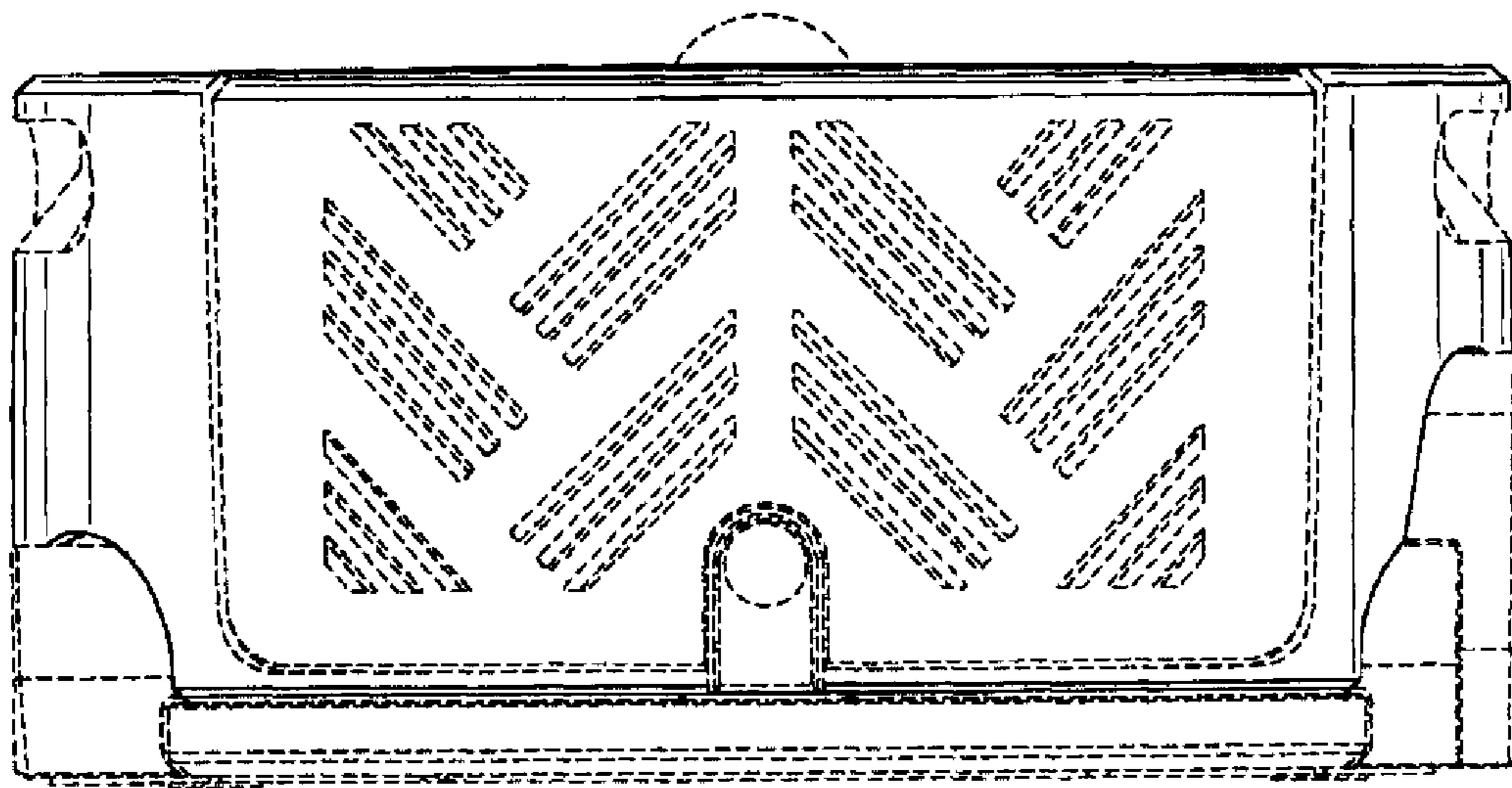

FIG. 5

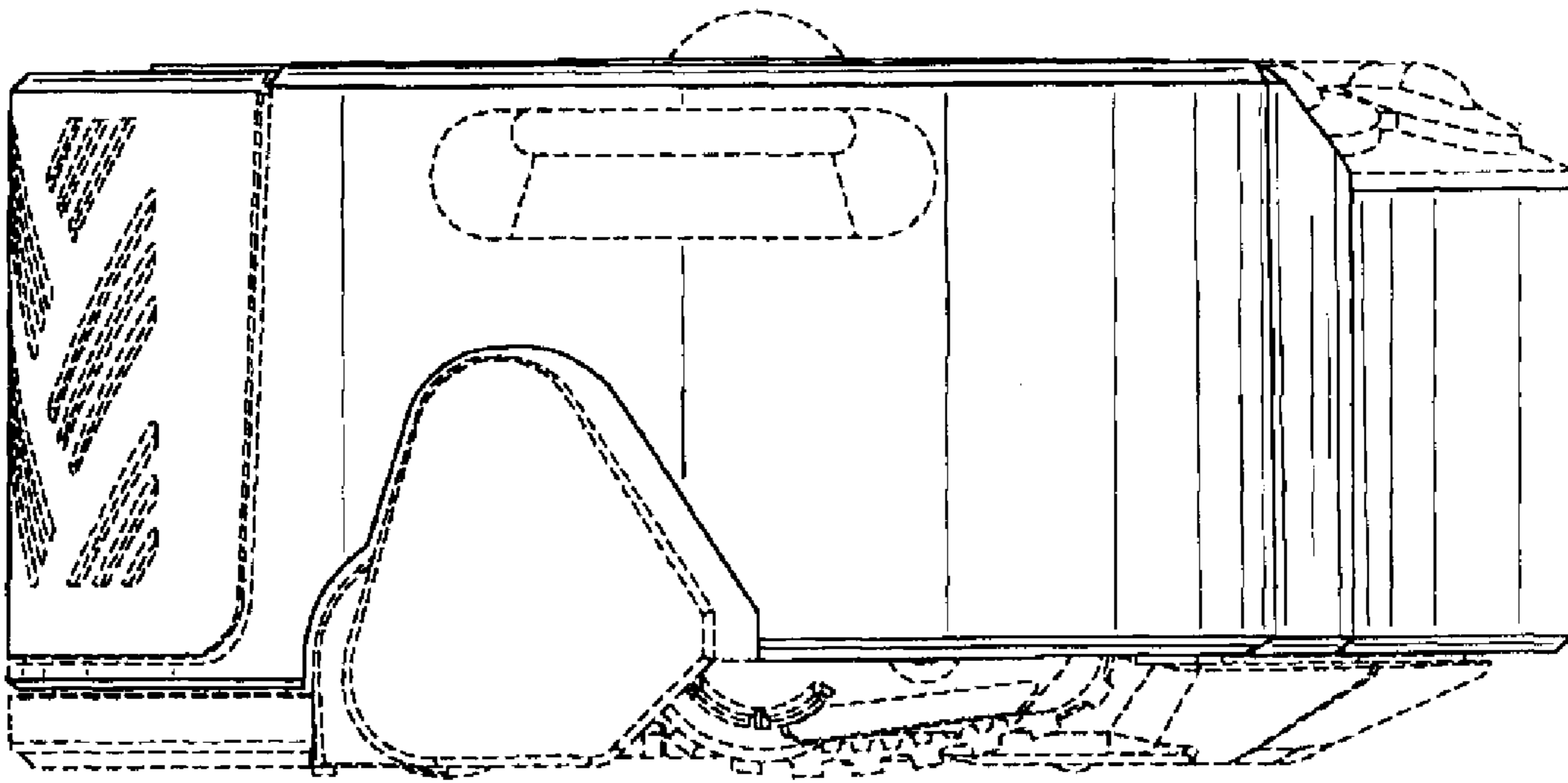

FIG. 6

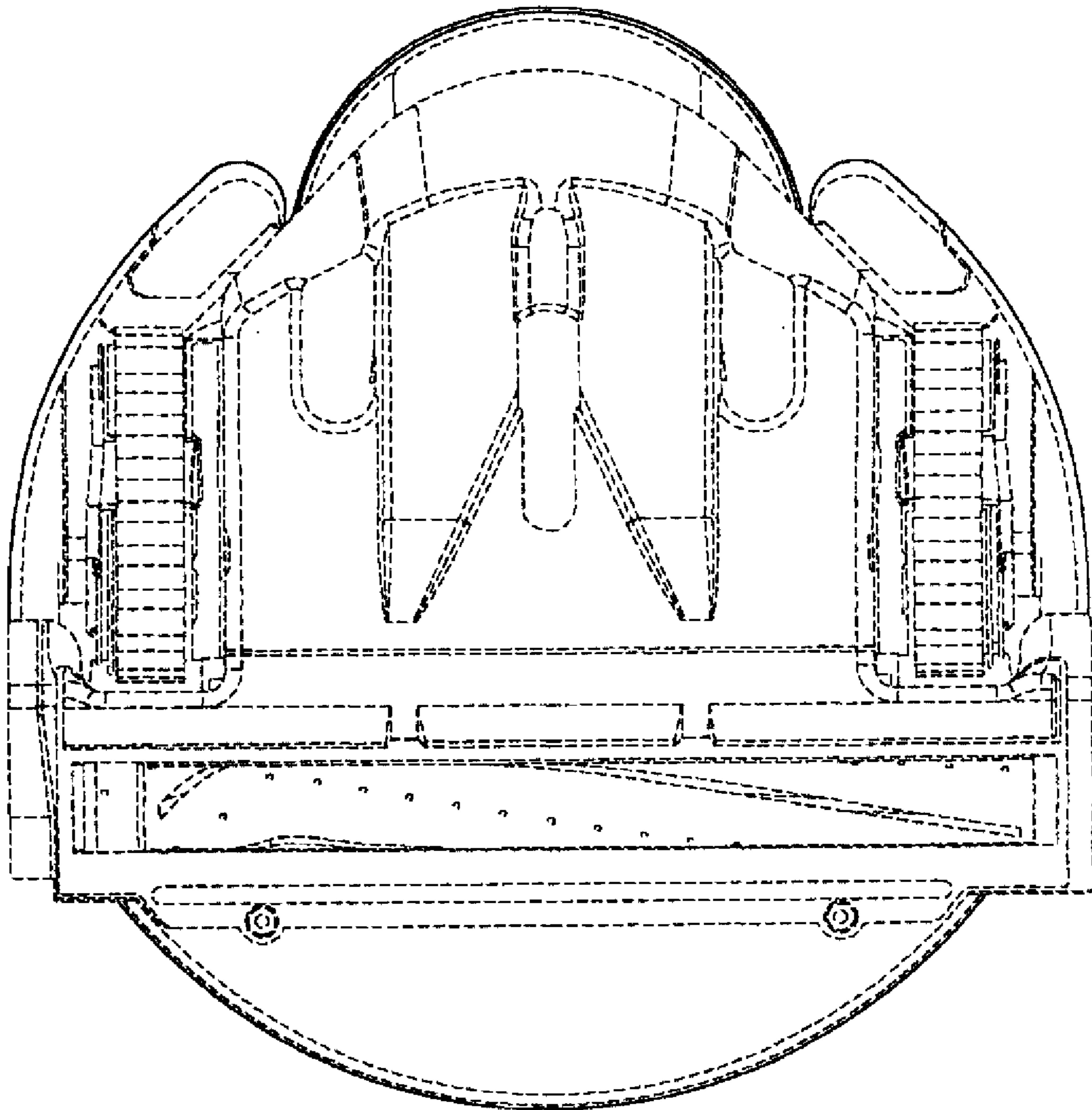

FIG. 7