



US00D710545S

(12) **United States Design Patent**  
**Wu**

(10) **Patent No.:** **US D710,545 S**

(45) **Date of Patent:** **\*\* Aug. 5, 2014**

(54) **HEAD BELT**

(71) Applicant: **Tecmen Electronics Co., Ltd.**, Nanjing (CN)

(72) Inventor: **Ziqian Wu**, Nanjing (CN)

(73) Assignee: **Tecmen Electronics Co., Ltd.**, Nanjing (CN)

(\*\*) Term: **14 Years**

(21) Appl. No.: **29/476,714**

(22) Filed: **Dec. 16, 2013**

(51) **LOC (10) Cl.** ..... **29-02**

(52) **U.S. Cl.**  
USPC ..... **D29/102**

(58) **Field of Classification Search**  
USPC ..... D29/100, 102, 103, 106, 108; 2/171,  
2/183, 455, 410, 411, 414, 417, 418, 419,  
2/421, 425

See application file for complete search history.

(56) **References Cited**

**U.S. PATENT DOCUMENTS**

4,675,919	A *	6/1987	Heine et al.	2/410
4,766,610	A *	8/1988	Mattes	2/414
D363,145	S *	10/1995	Newman et al.	D29/106
D366,732	S *	1/1996	Gregg et al.	D29/108
D370,309	S *	5/1996	Stucky	D29/102
6,266,827	B1 *	7/2001	Lampe et al.	2/414
6,301,716	B1 *	10/2001	Ross	2/171
6,374,422	B1 *	4/2002	Gonzalez et al.	2/425
D469,928	S *	2/2003	Keen et al.	D29/112

D482,163	S *	11/2003	Brown	D29/102
6,966,074	B2 *	11/2005	Huh	2/414
D564,134	S *	3/2008	Brundage	D29/102
D564,406	S *	3/2008	Chandler	D11/200
D589,686	S *	4/2009	Lowe et al.	D2/877
7,975,318	B2 *	7/2011	Zuber	2/417
8,287,045	B1 *	10/2012	Donohue et al.	297/393
8,627,517	B2 *	1/2014	Ahlgren et al.	2/416
2006/0225187	A1 *	10/2006	Wu	2/425
2008/0238174	A1 *	10/2008	Cinquanta	297/397

\* cited by examiner

*Primary Examiner* — Elizabeth J Oswecki

(74) *Attorney, Agent, or Firm* — Leydig, Voit & Mayer, Ltd.

(57) **CLAIM**

The ornamental design for a head belt, as shown and described.

**DESCRIPTION**

FIG. 1 is a top, front, right side perspective view of a head belt showing my new design;

FIG. 2 is a top plan view of the head belt shown in FIG. 1;

FIG. 3 is a bottom plan view of the head belt shown in FIG. 1;

FIG. 4 is a rear elevational view of the head belt shown in FIG. 1;

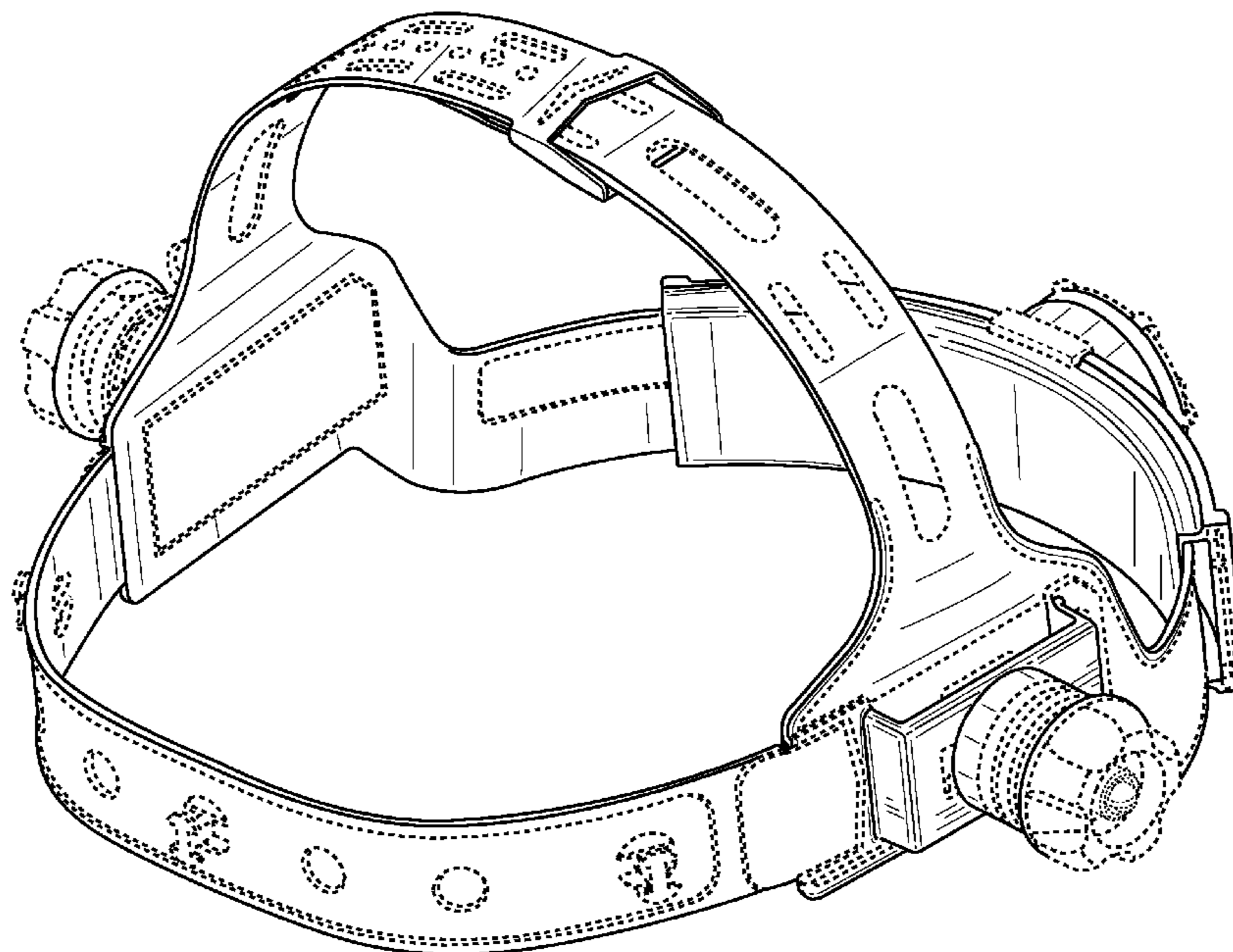
FIG. 5 is a front elevational view of the head belt shown in FIG. 1;

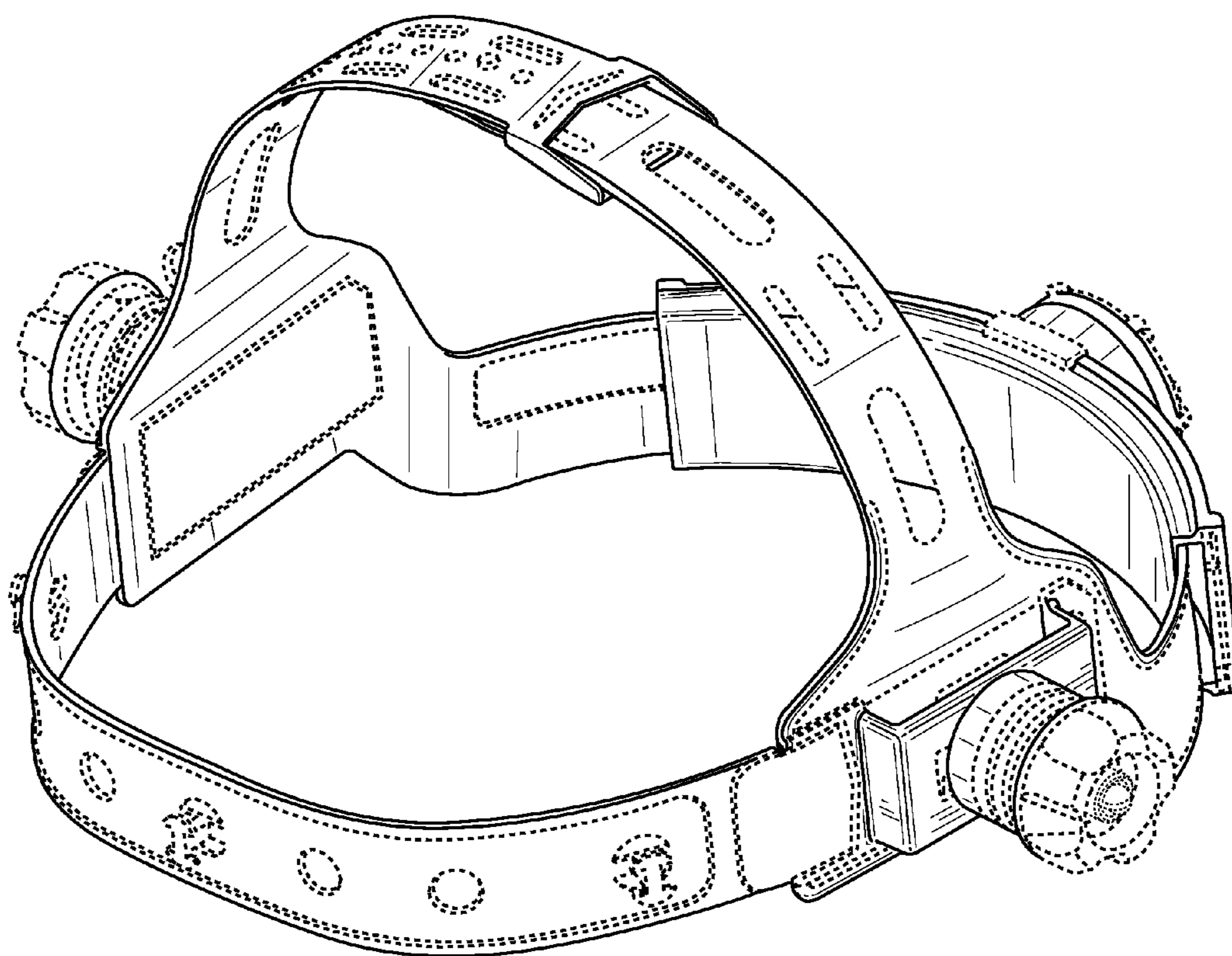
FIG. 6 is a right elevational side view of the head belt shown in FIG. 1; and,

FIG. 7 is a left elevational side view of the head belt shown in FIG. 1.

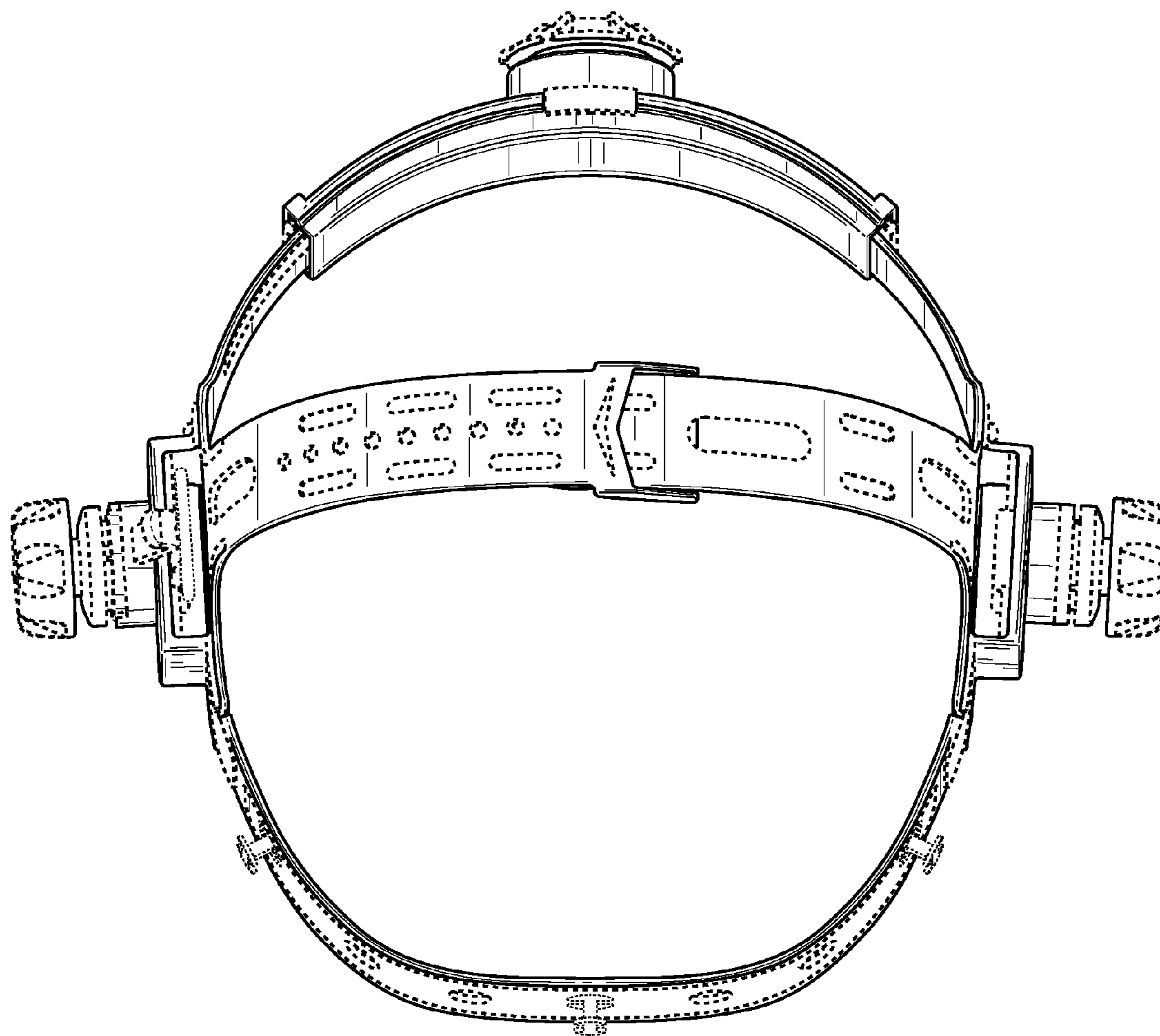
The broken lines shown in the drawings represent portions of the head belt that form no part of the claimed design.

**1 Claim, 7 Drawing Sheets**

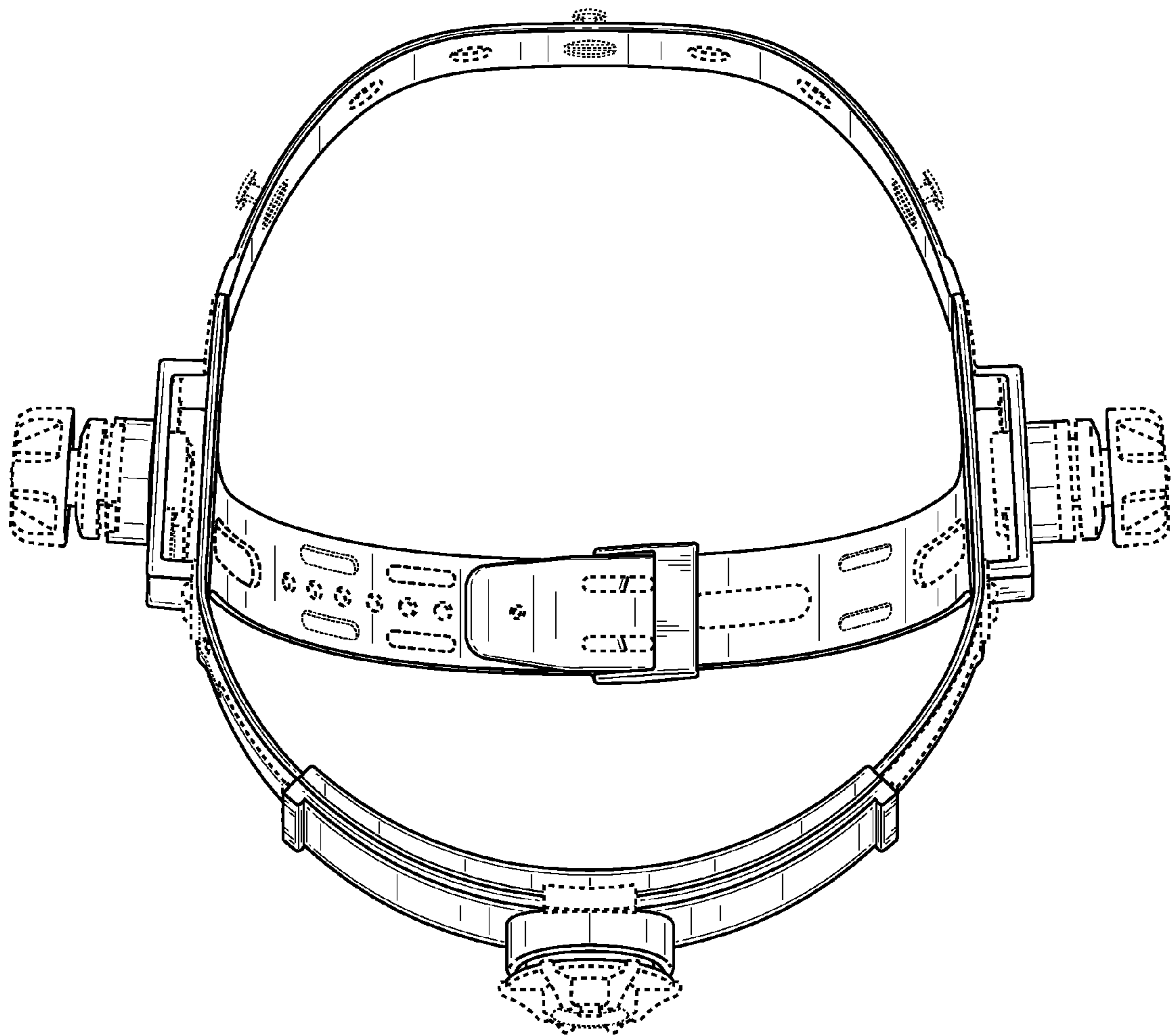




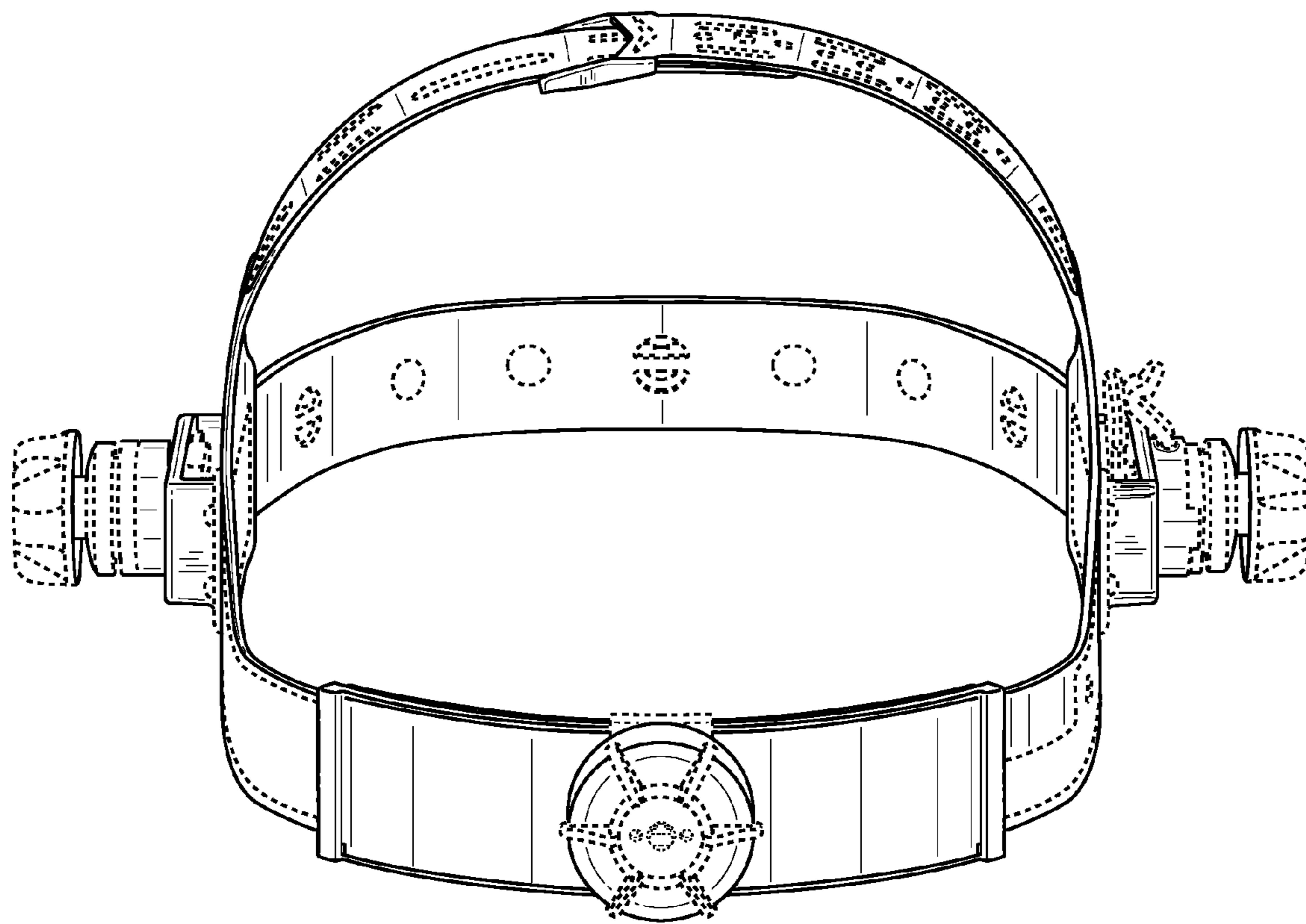
**FIG. 1**



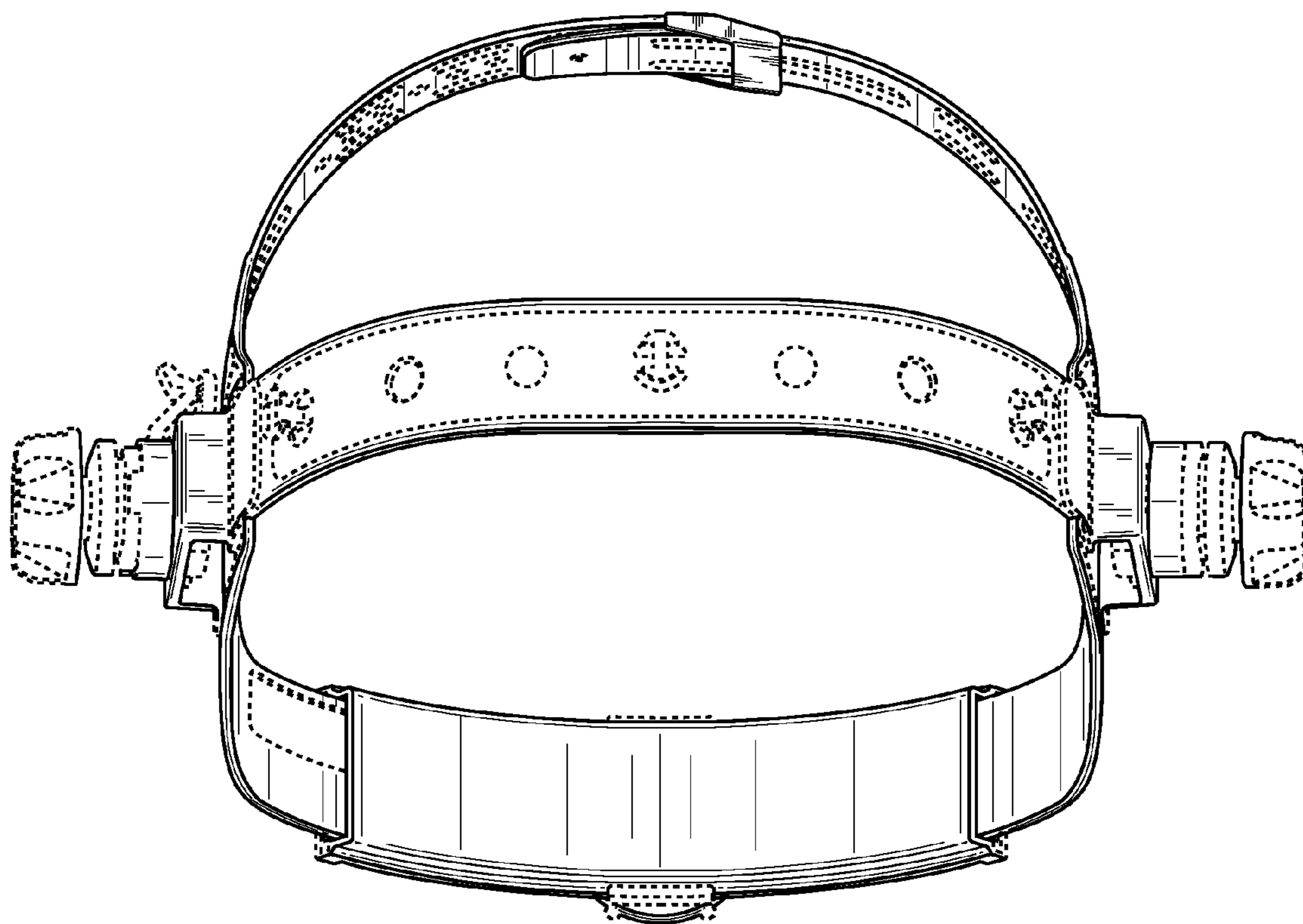
**FIG. 2**



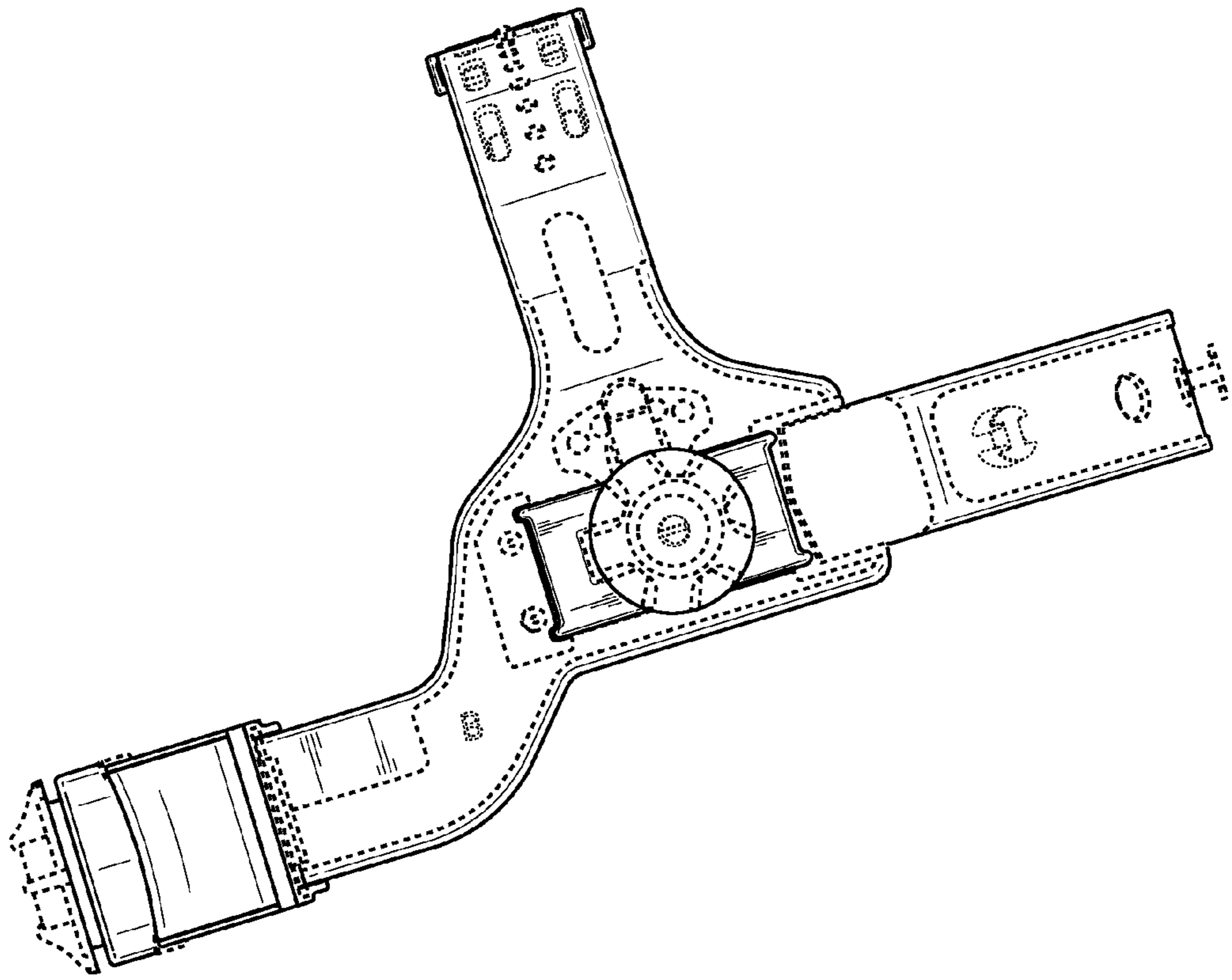
**FIG. 3**



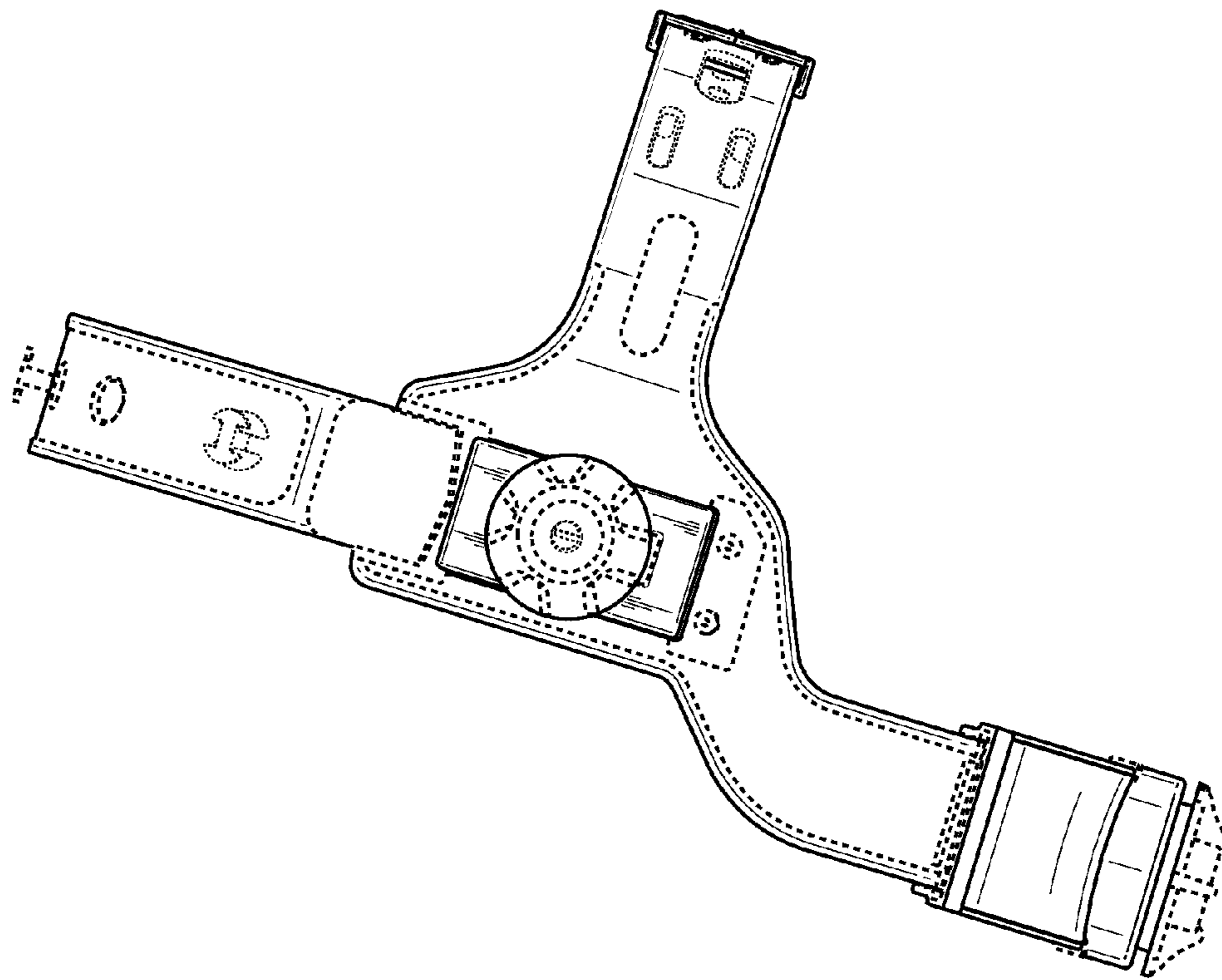
**FIG. 4**



**FIG. 5**



**FIG. 6**



**FIG. 7**