



US00D710500S

(12) **United States Design Patent**
Roeloffs

(10) **Patent No.:** **US D710,500 S**

(45) **Date of Patent:** **** Aug. 5, 2014**

(54) **MEDICAL INSTRUMENT**

(75) Inventor: **Bob Roeloffs**, Amsterdam (NL)

(73) Assignee: **Bridea Hong Kong Ltd.**, Hong Kong (HK)

(**) Term: **14 Years**

(21) Appl. No.: **29/417,628**

(22) Filed: **Apr. 5, 2012**

(51) **LOC (10) Cl.** **24-02**

(52) **U.S. Cl.**
USPC **D24/135**

(58) **Field of Classification Search**
USPC D24/135, 133, 143; 600/184, 201,
600/220–223, 235; 606/191–200
See application file for complete search history.

(56) **References Cited**

U.S. PATENT DOCUMENTS

3,650,266	A *	3/1972	Pestka et al.	600/222
3,769,968	A *	11/1973	Blount et al.	600/223
D274,356	S *	6/1984	Riedell	D24/135
D299,532	S *	1/1989	Cecil et al.	D24/135
5,997,474	A *	12/1999	Batchelor	600/220
D558,344	S *	12/2007	Saddlemire et al.	D24/135
D564,657	S *	3/2008	Tsai	D24/135
D578,646	S *	10/2008	Tsai	D24/135
D612,046	S *	3/2010	Tsai	D24/135
2002/0055670	A1 *	5/2002	Weiss	600/220
2002/0156350	A1 *	10/2002	Nieto	600/223
2003/0176772	A1 *	9/2003	Yang	600/220
2009/0177044	A1 *	7/2009	Cohen et al.	600/220

FOREIGN PATENT DOCUMENTS

CN	302342871	*	3/2013
EM	001768250-0001	*	11/2010
JP	D1478898	*	9/2013

* cited by examiner

Primary Examiner — Bridget L Eland

(74) *Attorney, Agent, or Firm* — Fross Zelnick Lehrman & Zissu, P.C.; Charles T. J. Weigell, Esq.

(57) **CLAIM**

The ornamental design for a medical instrument, as shown and described.

DESCRIPTION

FIG. 1 is a bottom front perspective view of a medical instrument showing my new design;
 FIG. 2 is a top rear perspective view of the medical instrument shown in FIG. 1;
 FIG. 3 is a bottom rear perspective view of the medical instrument shown in FIG. 1;
 FIG. 4 is top front perspective view of the medical instrument shown in FIG. 1;
 FIG. 5 is a left side view of the medical instrument shown in FIG. 1;
 FIG. 6 is a right side view of the medical instrument shown in FIG. 1;
 FIG. 7 is a rear view of the medical instrument shown in FIG. 1;
 FIG. 8 is a front view of the medical instrument shown in FIG. 1;
 FIG. 9 is a top view of the medical instrument shown in FIG. 1;
 FIG. 10 is a bottom view of the medical instrument shown in FIG. 1;
 FIG. 11 is a rear view of the medical instrument shown in FIG. 1, shown in an open position;
 FIG. 12 is a bottom front perspective view of the medical instrument shown in FIG. 1, shown in an open position;
 FIG. 13 is a front view of the medical instrument shown in FIG. 1, shown in an open position.
 FIG. 14 is a front perspective view of the medical instrument shown in FIG. 1, shown in an open position; and,
 FIG. 15 is a top rear perspective view of the medical instrument shown in FIG. 1, shown in an open position.

1 Claim, 15 Drawing Sheets

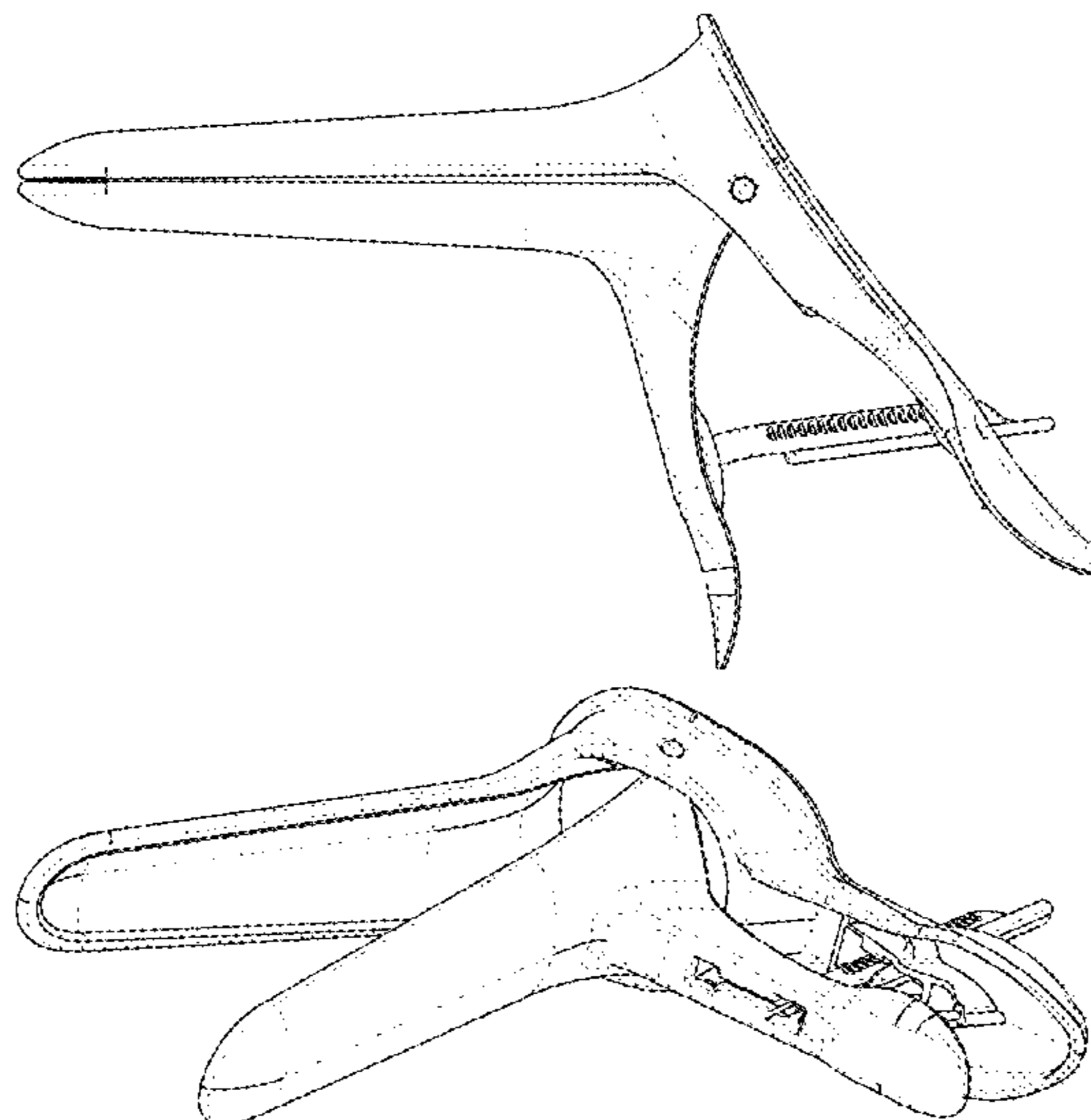

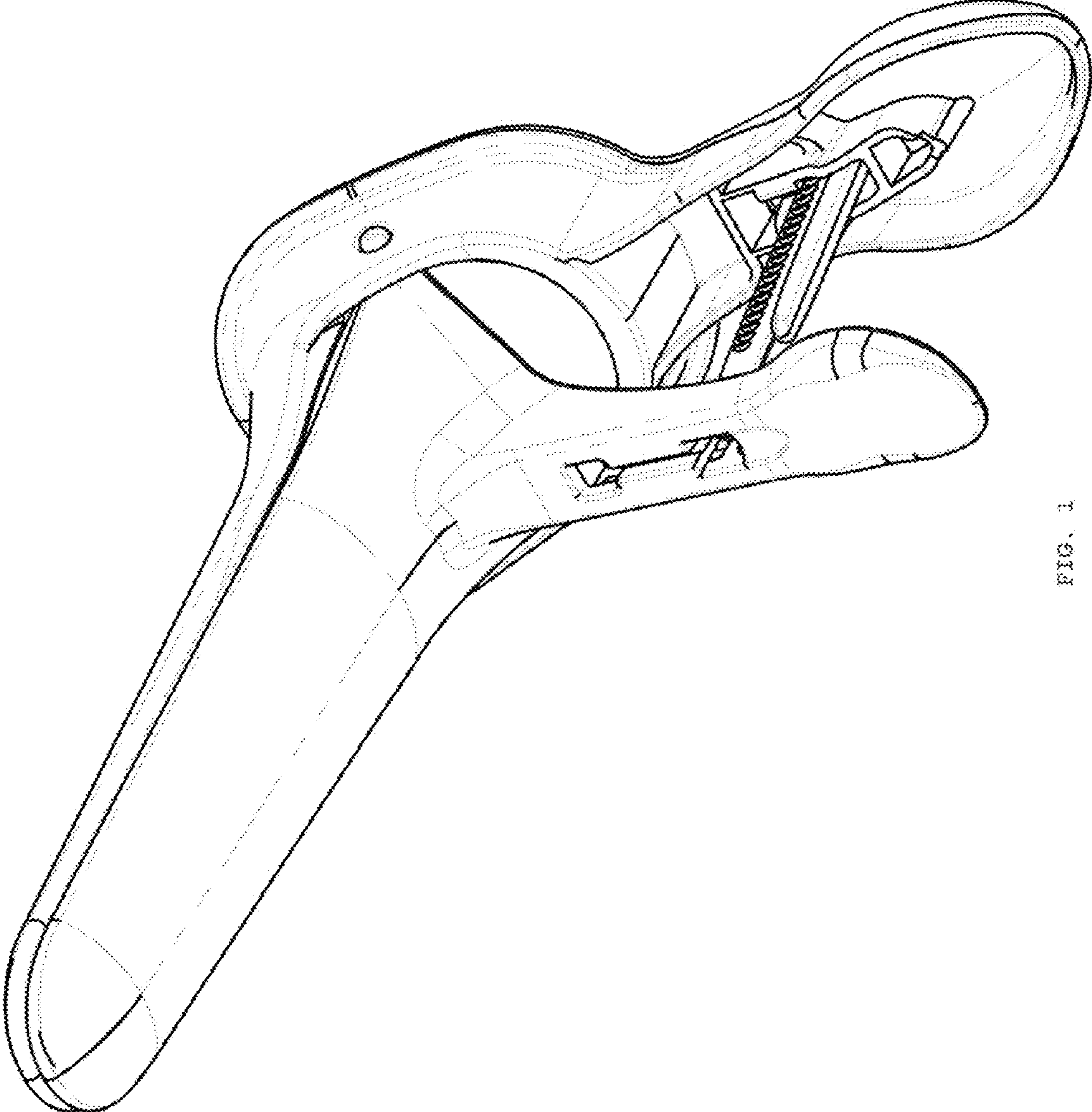

FIG. 3

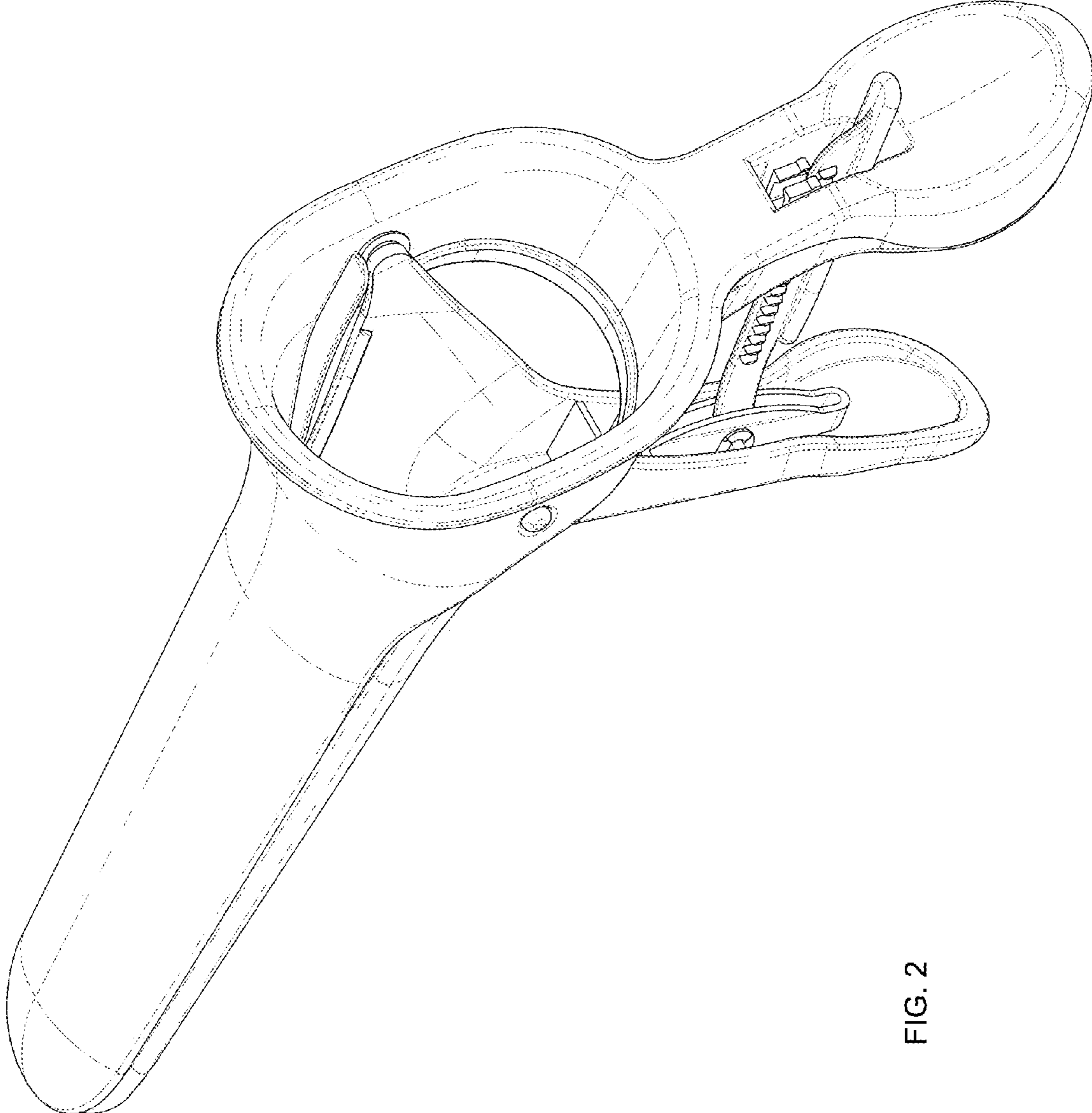

FIG. 2

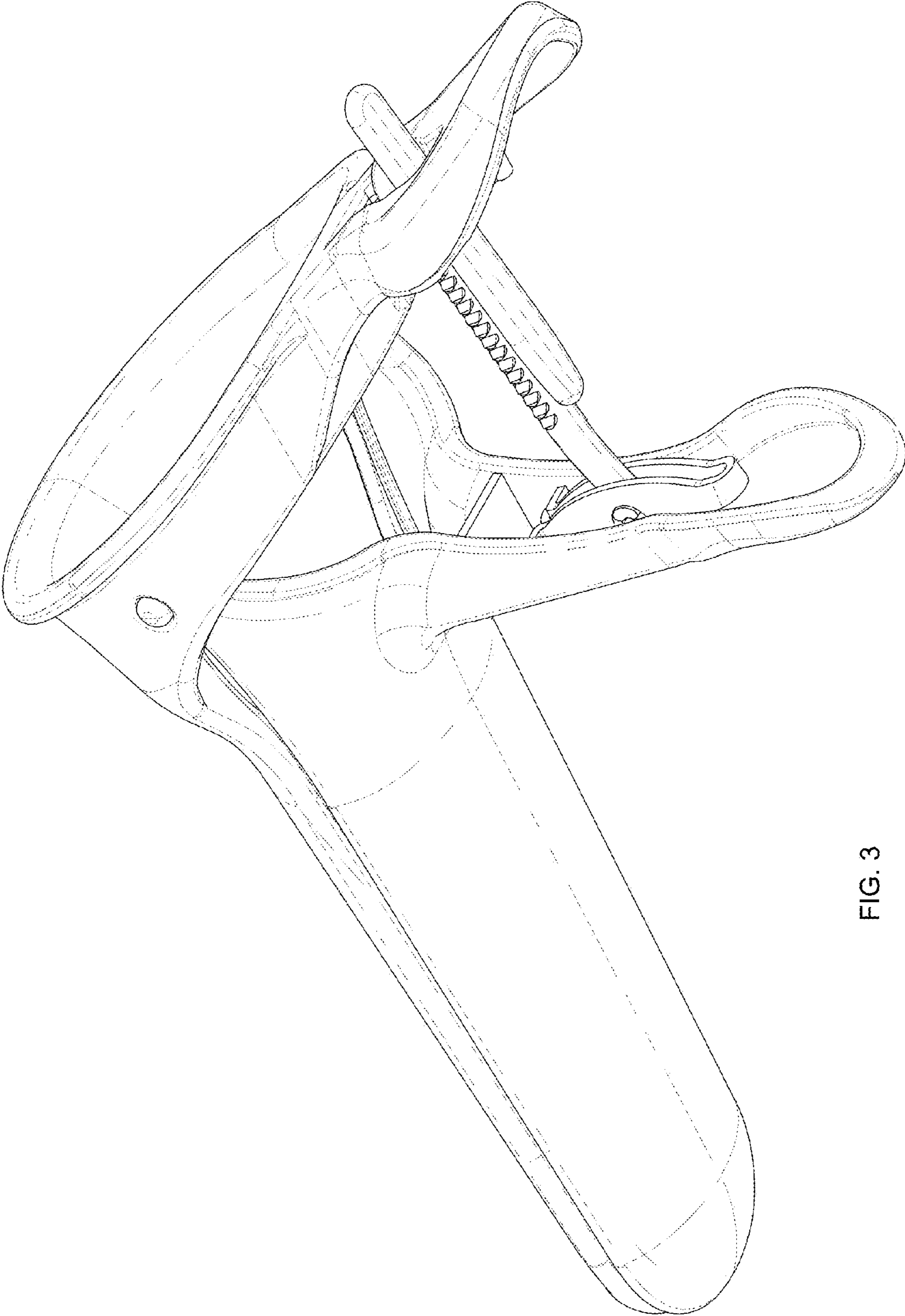

FIG. 3

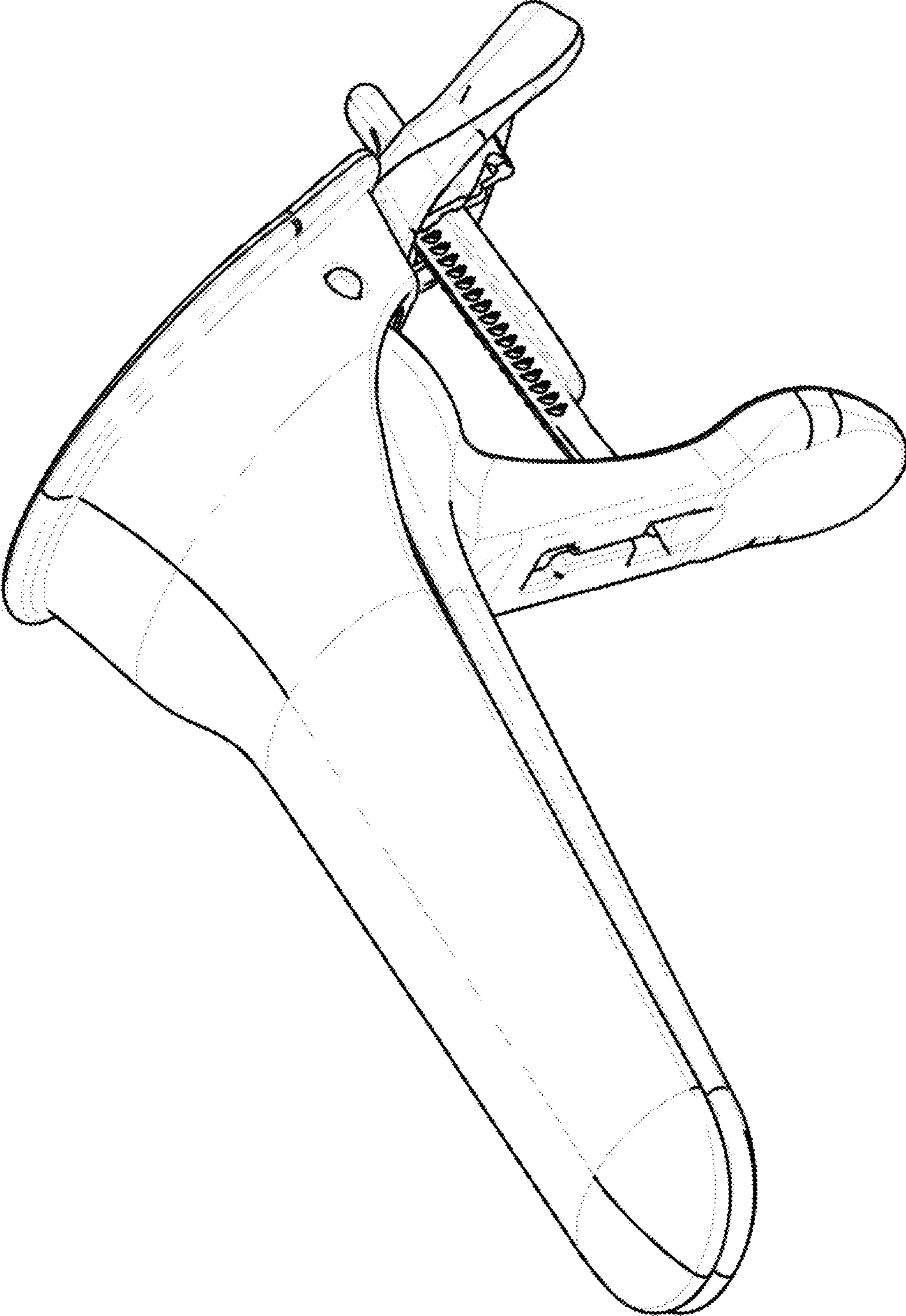

FIG. 4

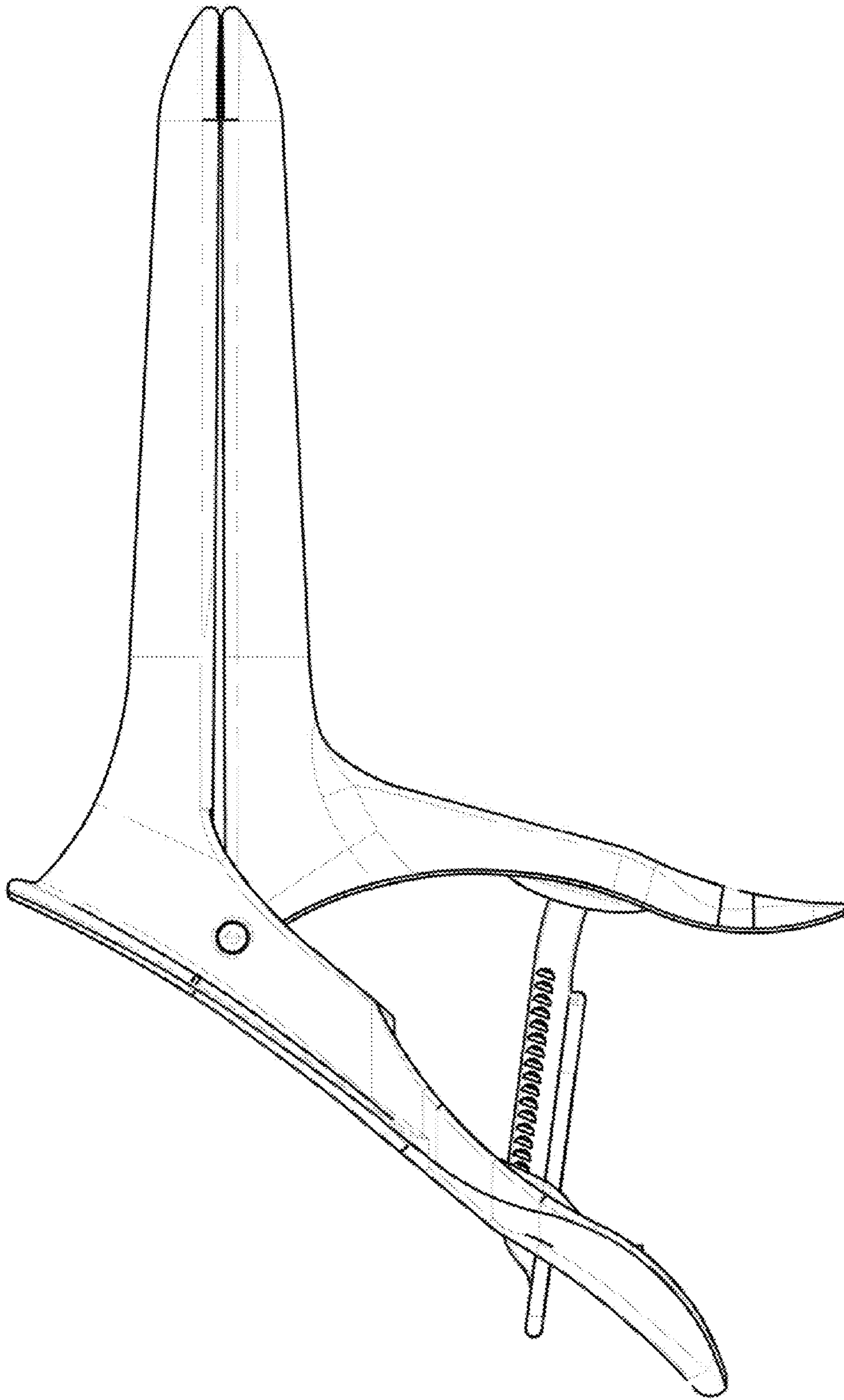

FIG. 5

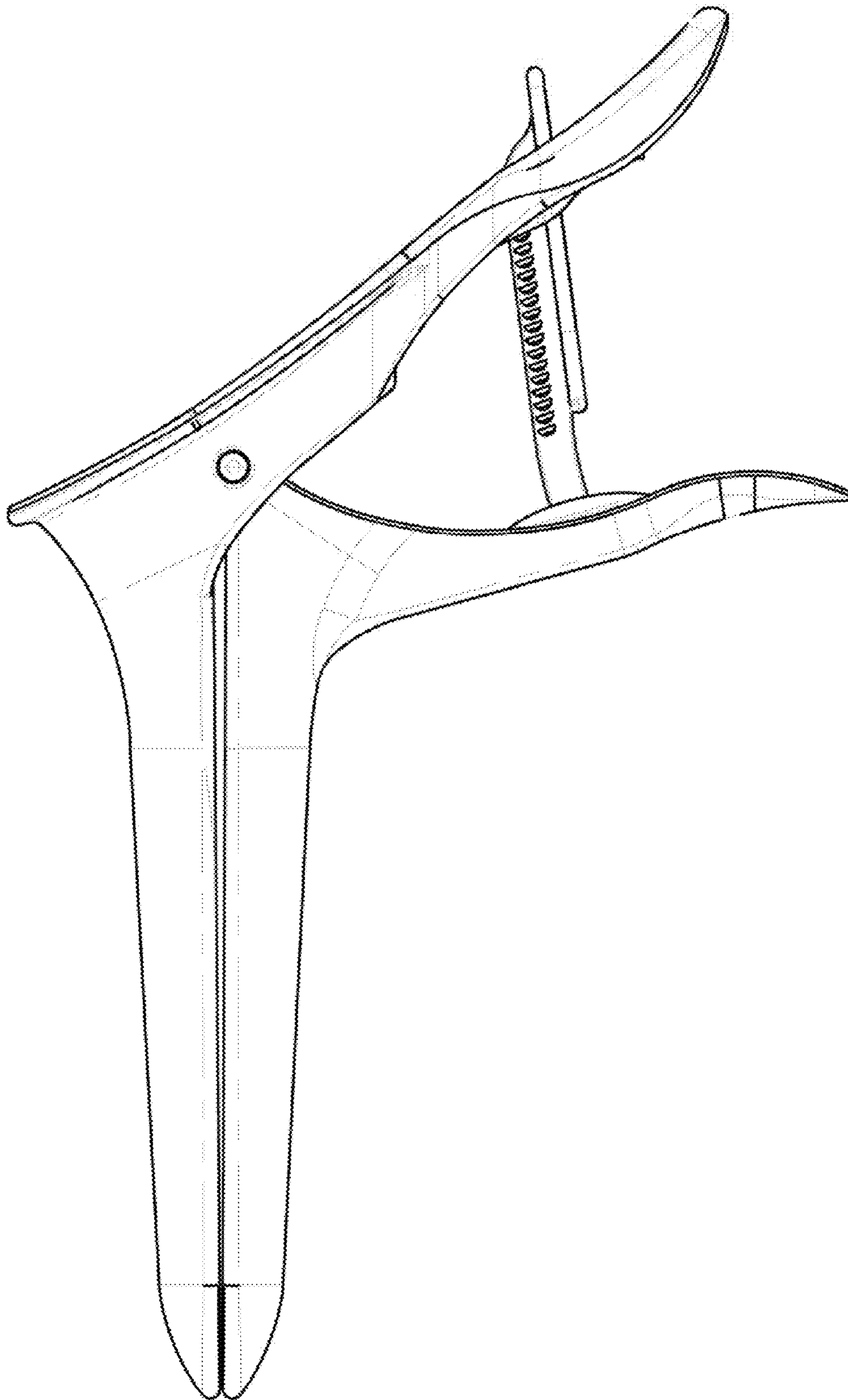

FIG. 6

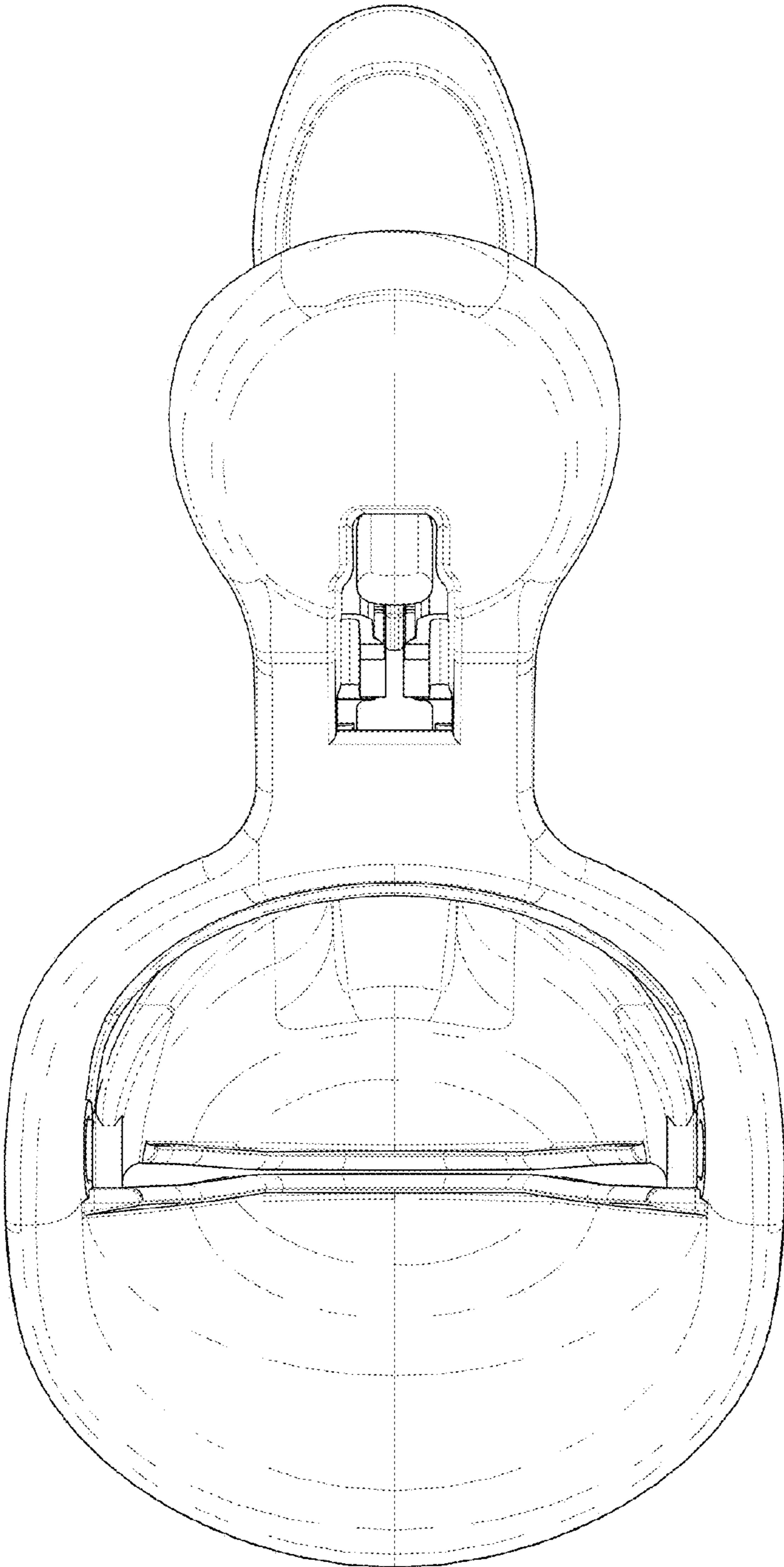

FIG. 7

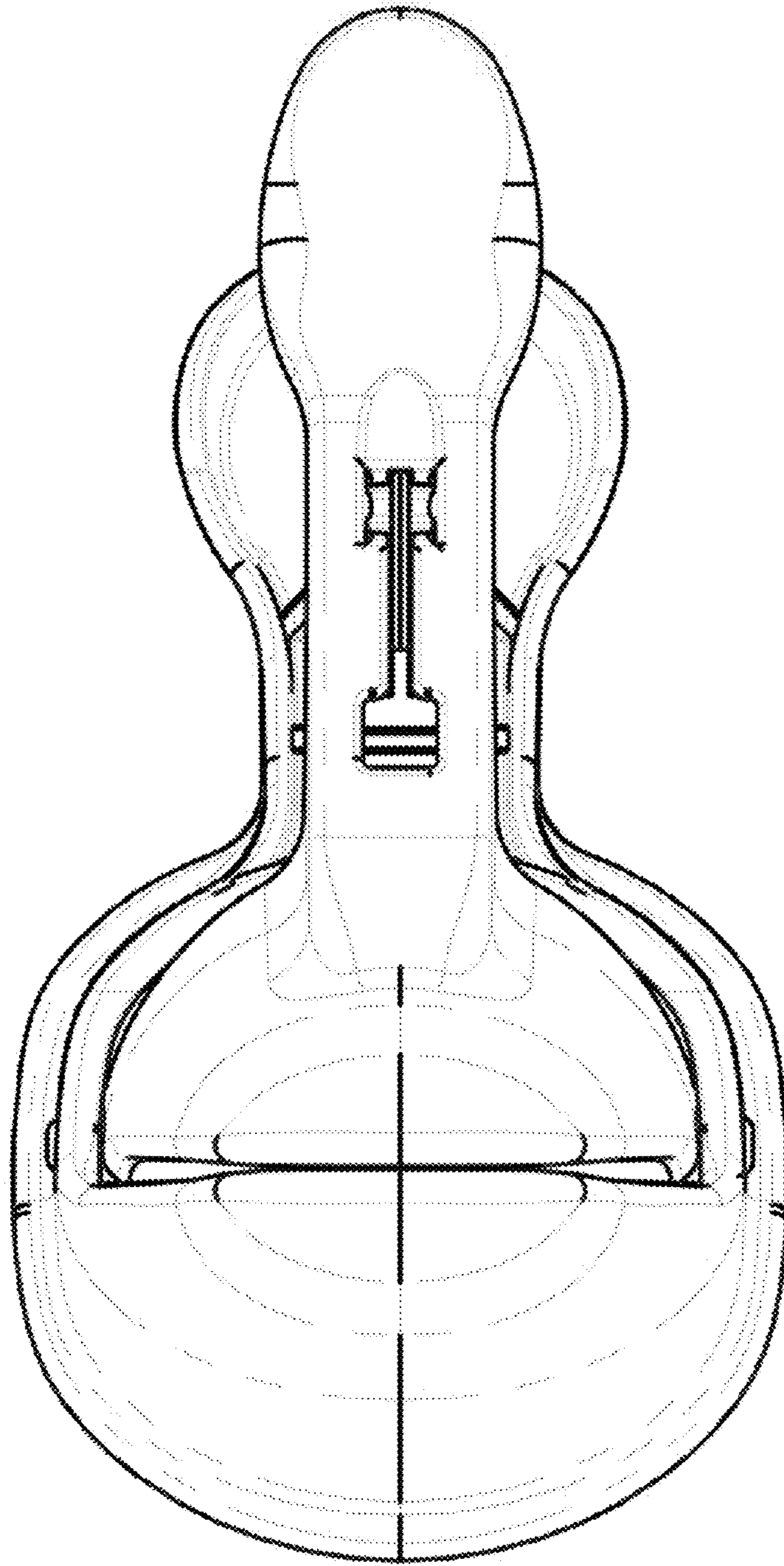

FIG. 8

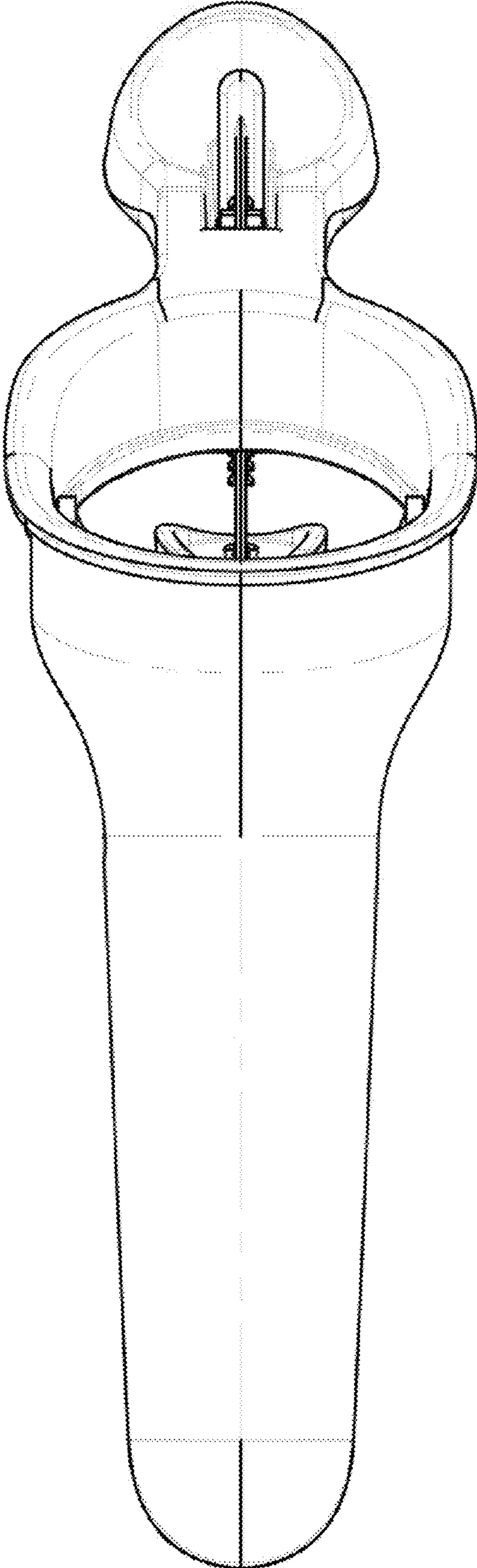

FIG. 9

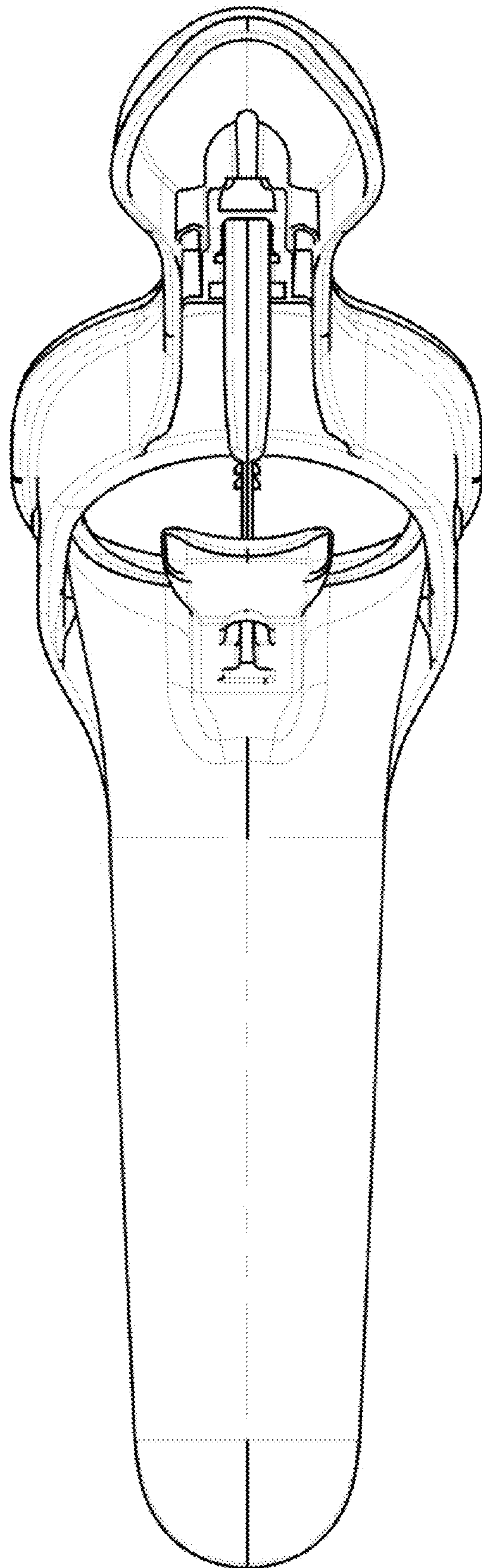

FIG. 10

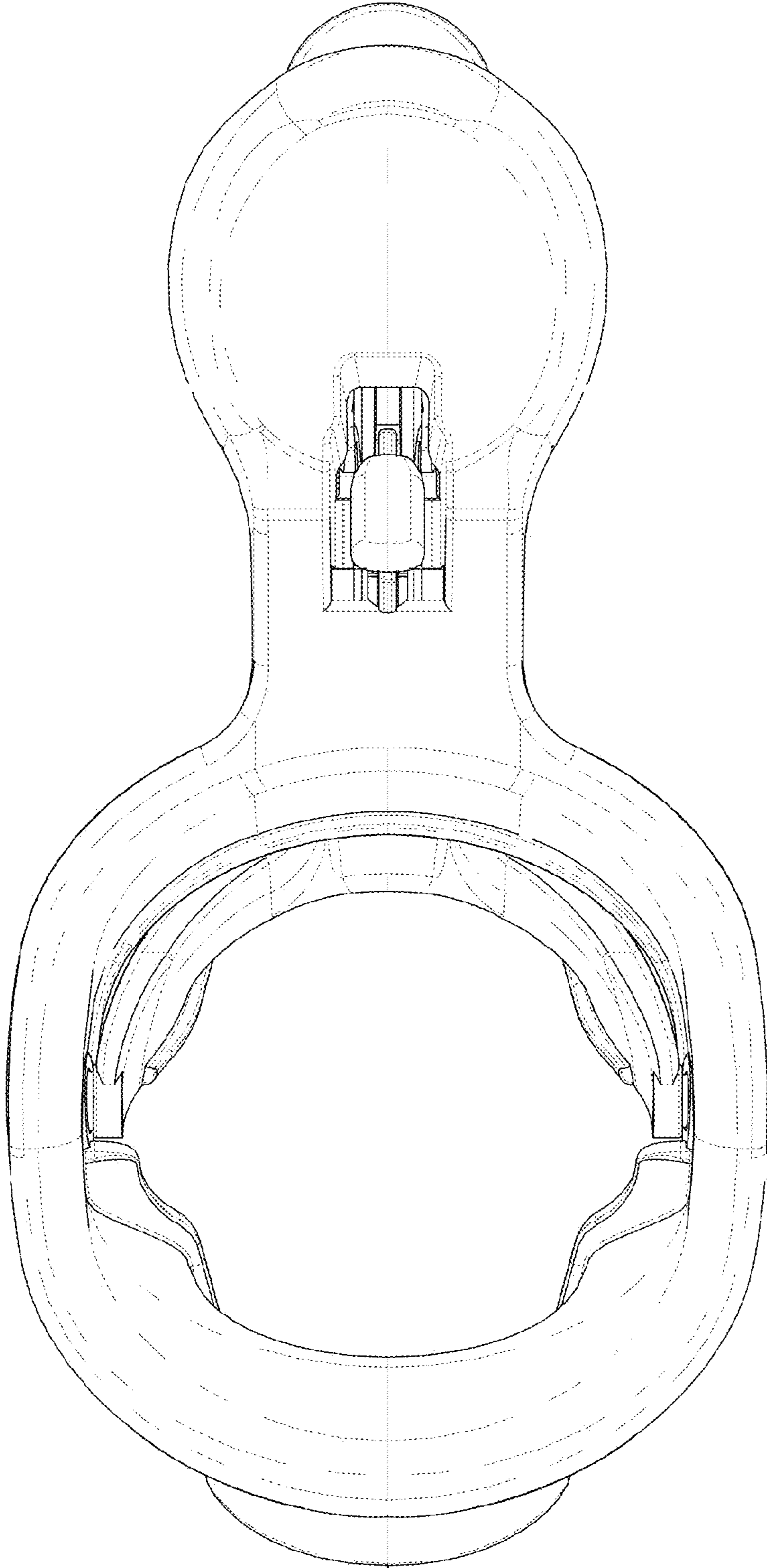

FIG. 11

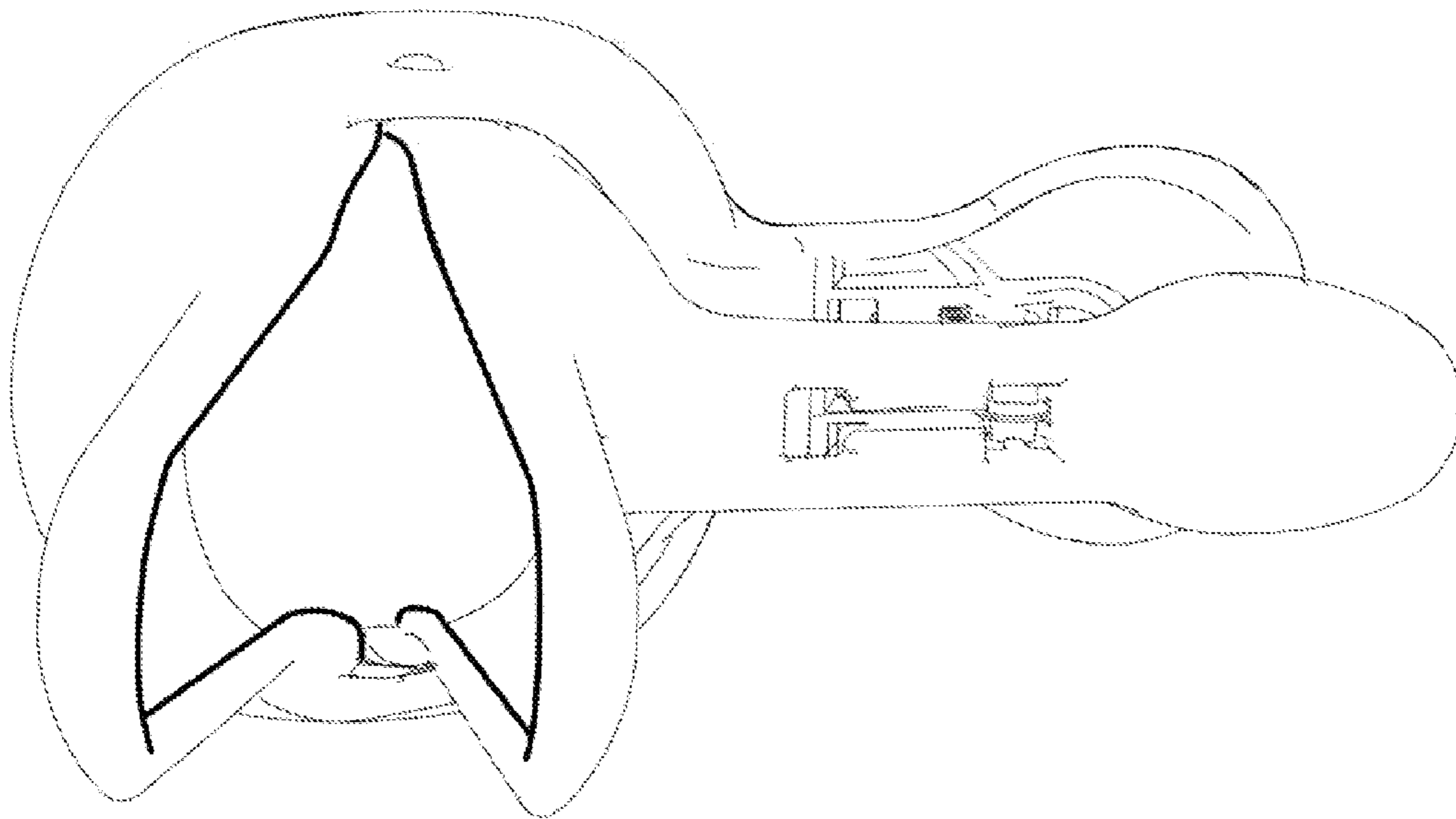

FIG. 12

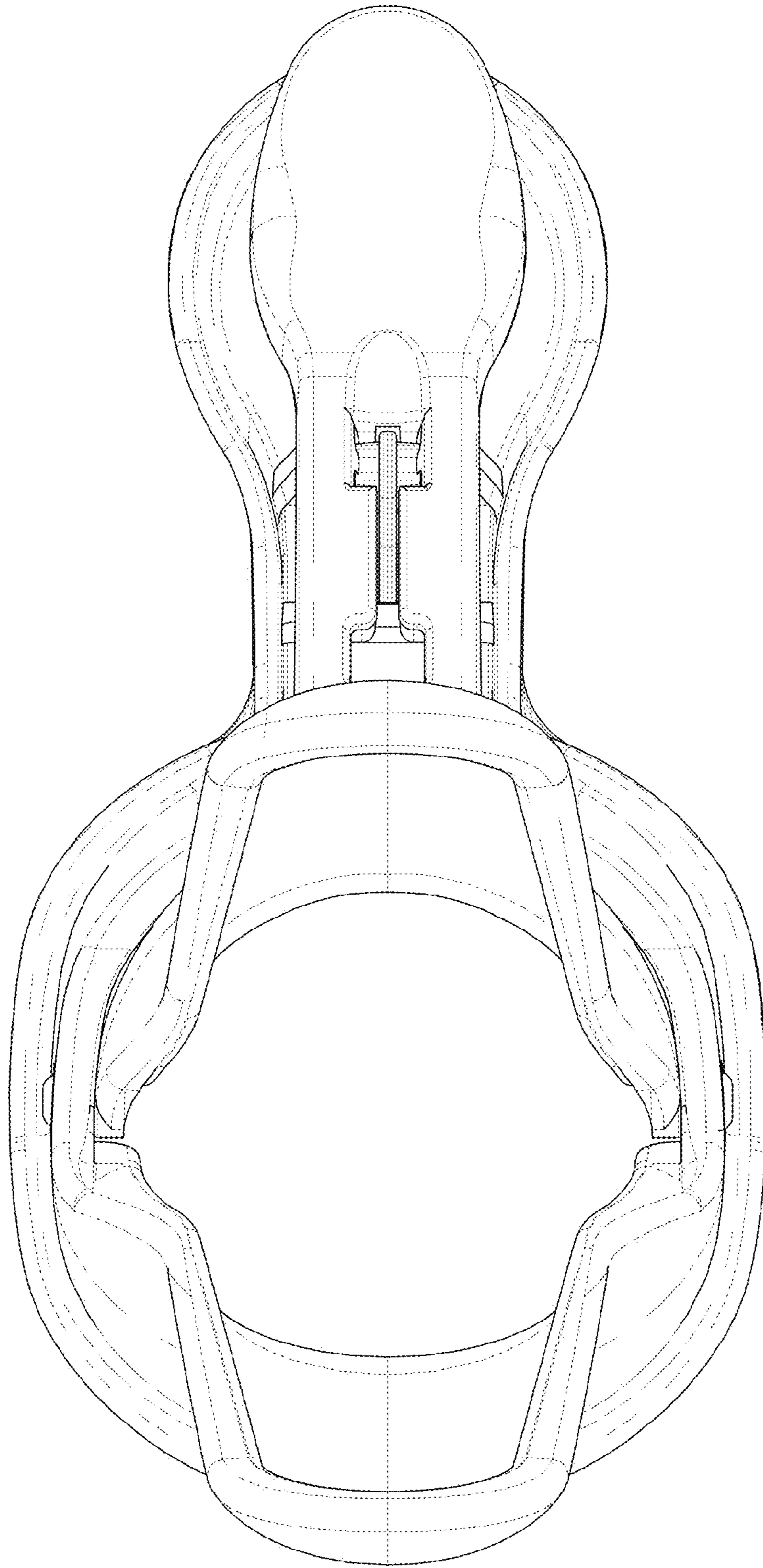

FIG. 13

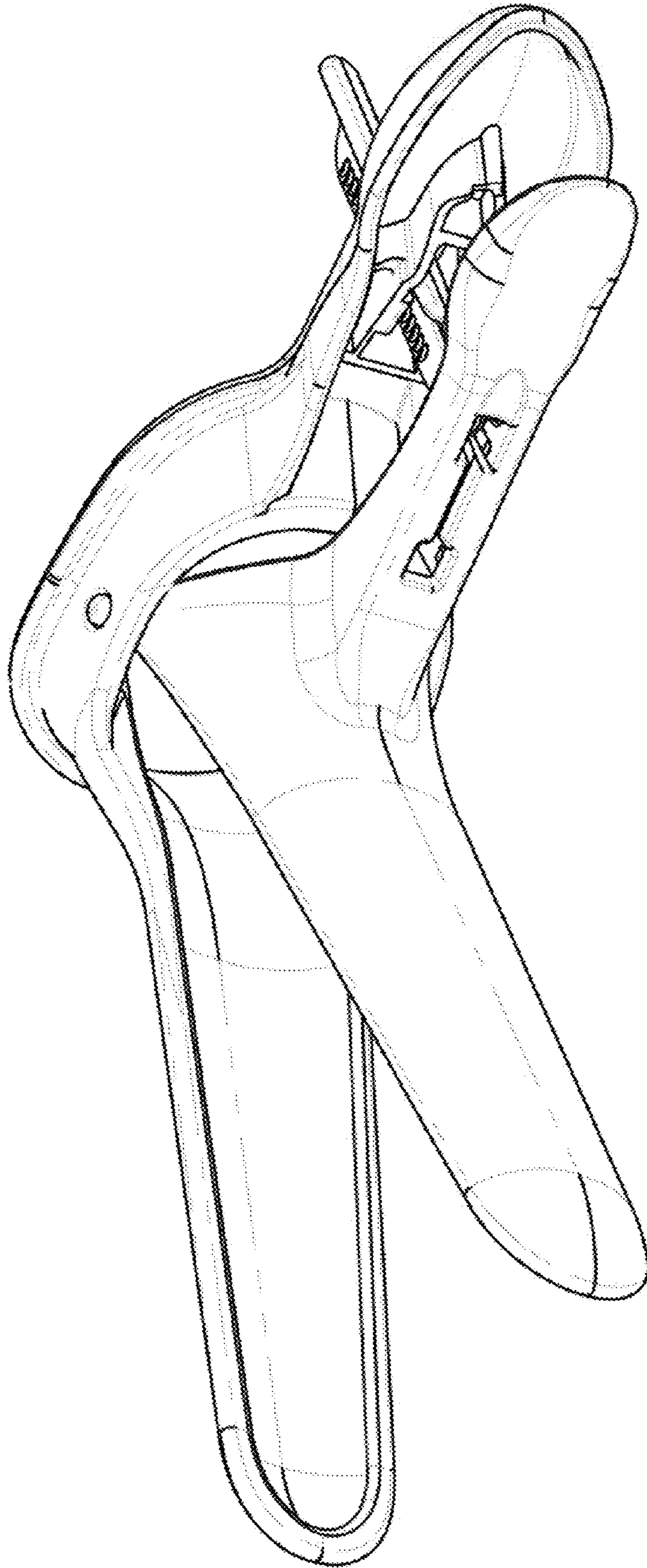

FIG. 14

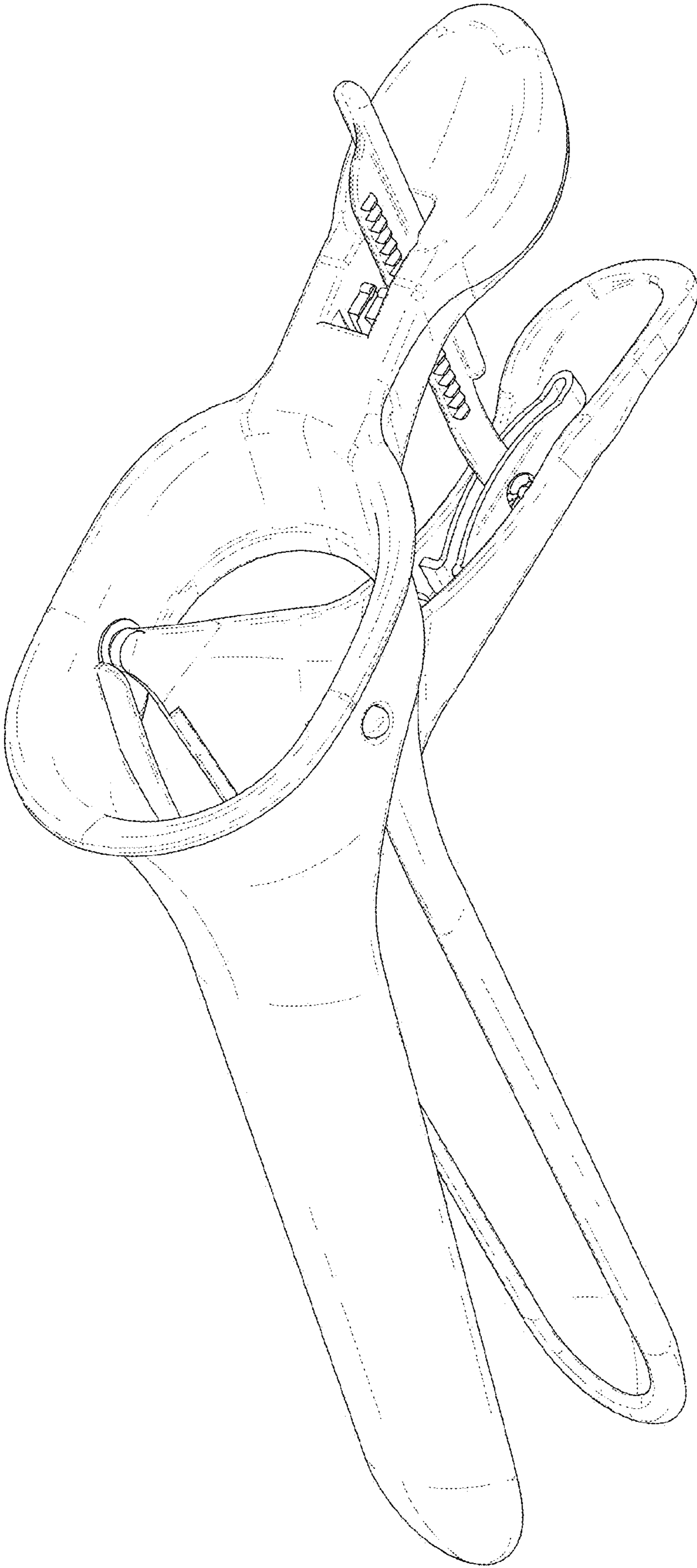

FIG. 15

UNITED STATES PATENT AND TRADEMARK OFFICE
CERTIFICATE OF CORRECTION

PATENT NO. : D710,500 S
APPLICATION NO. : 29/417628
DATED : August 5, 2014
INVENTOR(S) : Bob Roeloffs

Page 1 of 17

It is certified that error appears in the above-identified patent and that said Letters Patent is hereby corrected as shown below:

The title page showing the illustrative figure should be deleted to be replaced with the attached title page.

In the Drawings

The drawing sheets, consisting of Figs. 1-15, should be deleted to be replaced with the drawing sheets, consisting of Figs. 1-15, as shown on the attached pages.

Signed and Sealed this
Second Day of December, 2014



Michelle K. Lee
Deputy Director of the United States Patent and Trademark Office

(12) **United States Design Patent** (10) Patent No.: **US D710,500 S**
Roeloffs (45) Date of Patent: **** Aug. 5, 2014**

(54) **MEDICAL INSTRUMENT**
 (75) Inventor: **Bob Roeloffs, Amsterdam (NL)**
 (73) Assignee: **Bridea Hong Kong Ltd., Hong Kong (HK)**
 (**) Term: **14 Years**
 (21) Appl. No.: **29/417,628**
 (22) Filed: **Apr. 5, 2012**
 (51) **LOC (10) Cl.** **24-02**
 (52) **U.S. Cl.**
 USPC **D24/135**
 (58) **Field of Classification Search**
 USPC D24/135, 133, 143; 600/184, 201,
 600/220-223, 235; 606/191-200
 See application file for complete search history

Primary Examiner — Bridget L Eland
 (74) *Attorney, Agent, or Firm* — Fross Zelnick Lehman & Zissu, P.C.; Charles T. J. Weigell, Esq.

(57) **CLAIM**
 The ornamental design for a medical instrument, as shown and described.

DESCRIPTION

FIG. 1 is a bottom front perspective view of a medical instrument showing my new design;
 FIG. 2 is a top rear perspective view of the medical instrument shown in FIG. 1;
 FIG. 3 is a bottom rear perspective view of the medical instrument shown in FIG. 1;
 FIG. 4 is top front perspective view of the medical instrument shown in FIG. 1;
 FIG. 5 is a left side view of the medical instrument shown in FIG. 1;
 FIG. 6 is a right side view of the medical instrument shown in FIG. 1;
 FIG. 7 is a rear view of the medical instrument shown in FIG. 1;
 FIG. 8 is a front view of the medical instrument shown in FIG. 1;
 FIG. 9 is a top view of the medical instrument shown in FIG. 1;
 FIG. 10 is a bottom view of the medical instrument shown in FIG. 1;
 FIG. 11 is a rear view of the medical instrument shown in FIG. 1, shown in an open position;
 FIG. 12 is a bottom front perspective view of the medical instrument shown in FIG. 1, shown in an open position;
 FIG. 13 is a front view of the medical instrument shown in FIG. 1, shown in an open position;
 FIG. 14 is a front perspective view of the medical instrument shown in FIG. 1, shown in an open position; and,
 FIG. 15 is a top rear perspective view of the medical instrument shown in FIG. 1, shown in an open position.

(56) **References Cited**

U.S. PATENT DOCUMENTS

3,650,266	A *	3/1972	Pestka et al.	600/222
3,769,968	A *	11/1973	Blount et al.	600/223
D274,356	S *	6/1984	Riedell	D24/135
D299,532	S *	1/1989	Cecil et al.	D24/135
5,997,474	A *	12/1999	Batchelor	600/220
D558,344	S *	12/2007	Saddlemire et al.	D24/135
D564,657	S *	3/2008	Tsai	D24/135
D578,646	S *	10/2008	Tsai	D24/135
D612,046	S *	3/2010	Tsai	D24/135
2002/0055670	A1 *	5/2002	Weiss	600/220
2002/0156350	A1 *	10/2002	Nieto	600/223
2003/0176772	A1 *	9/2003	Yang	600/220
2009/0177044	A1 *	7/2009	Cohen et al.	600/220

FOREIGN PATENT DOCUMENTS

CN	302342871	*	3/2013
EM	001768250-0001	*	11/2010
JP	D1478898	*	9/2013

* cited by examiner

1 Claim, 15 Drawing Sheets

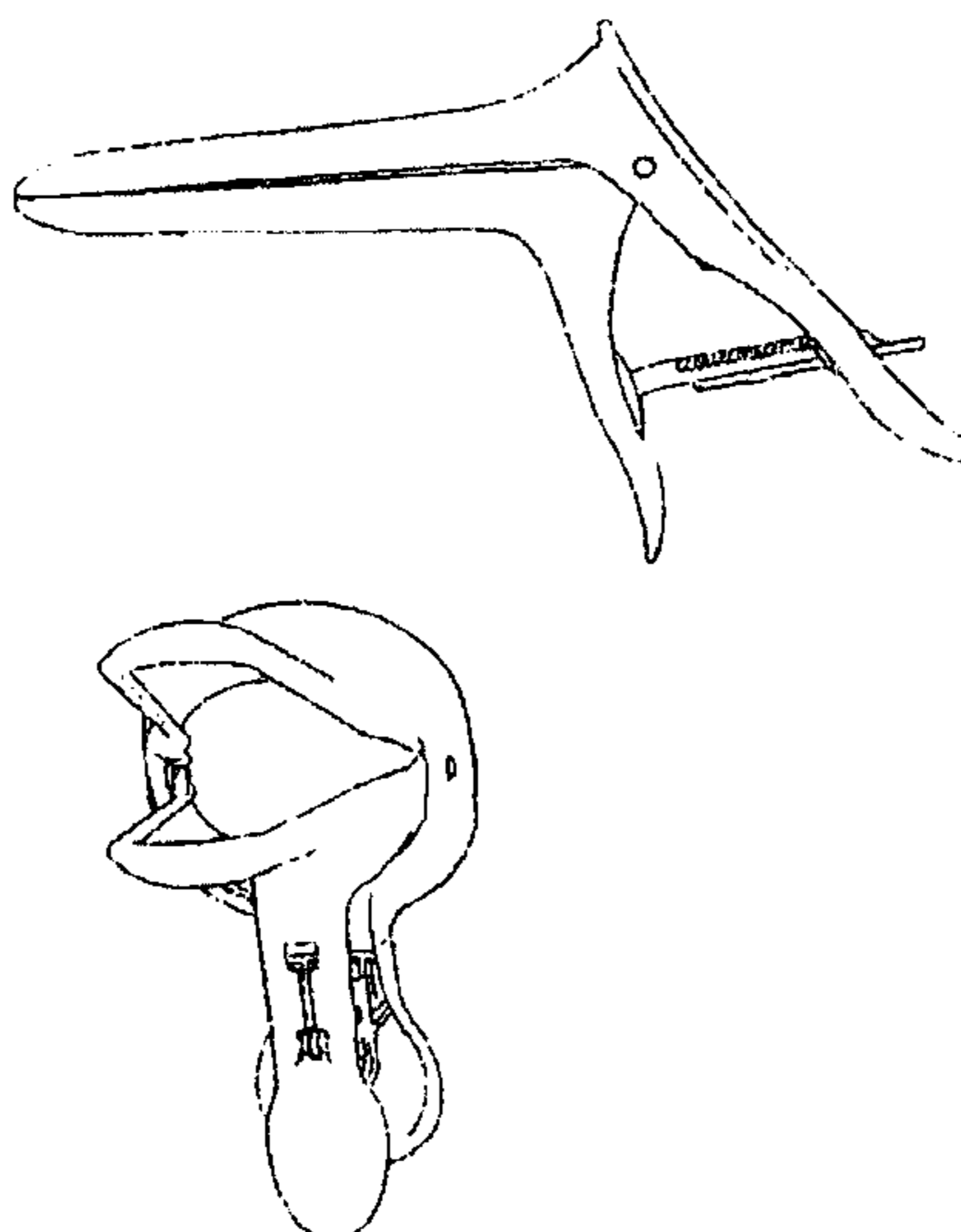

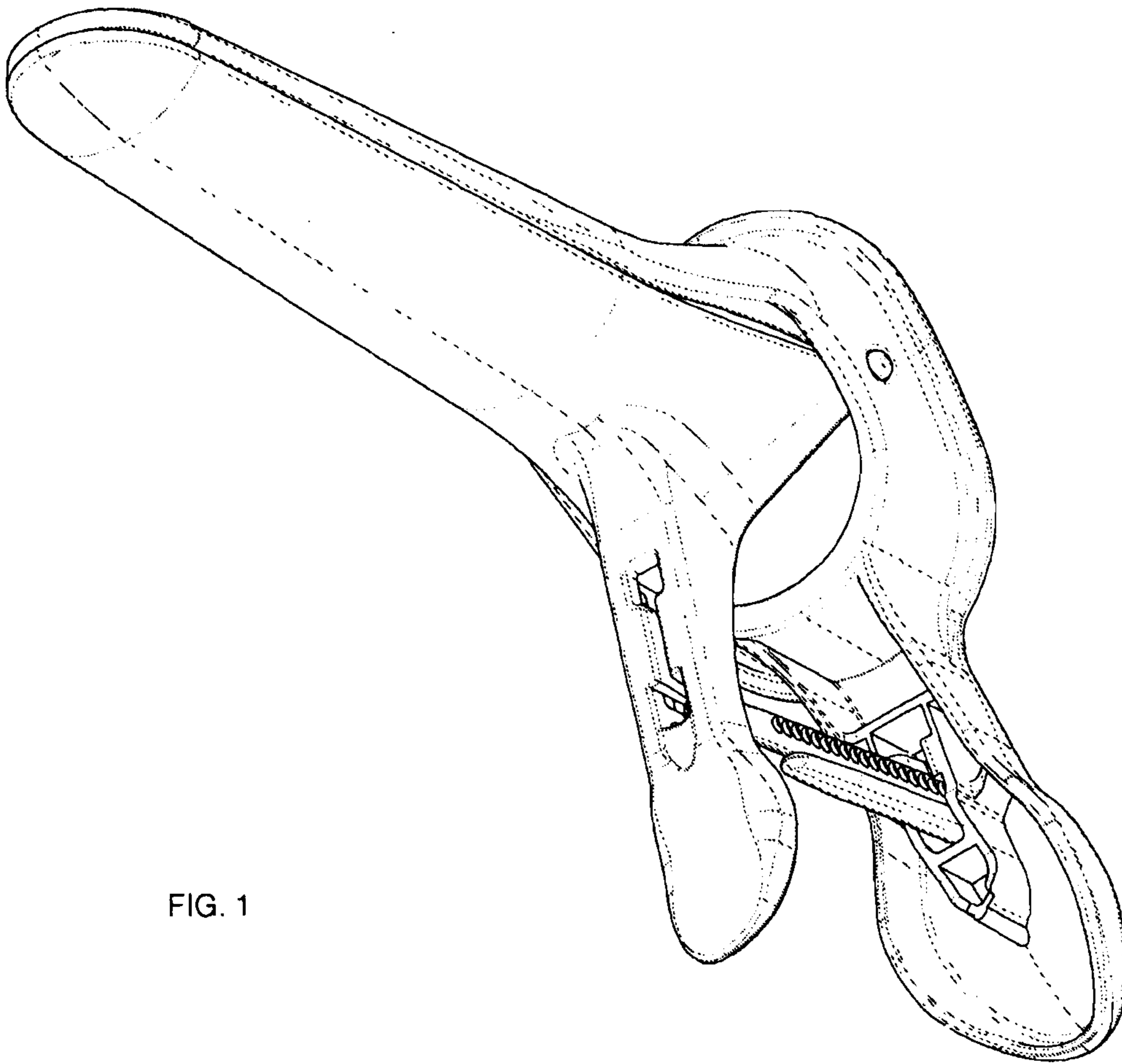

FIG. 1

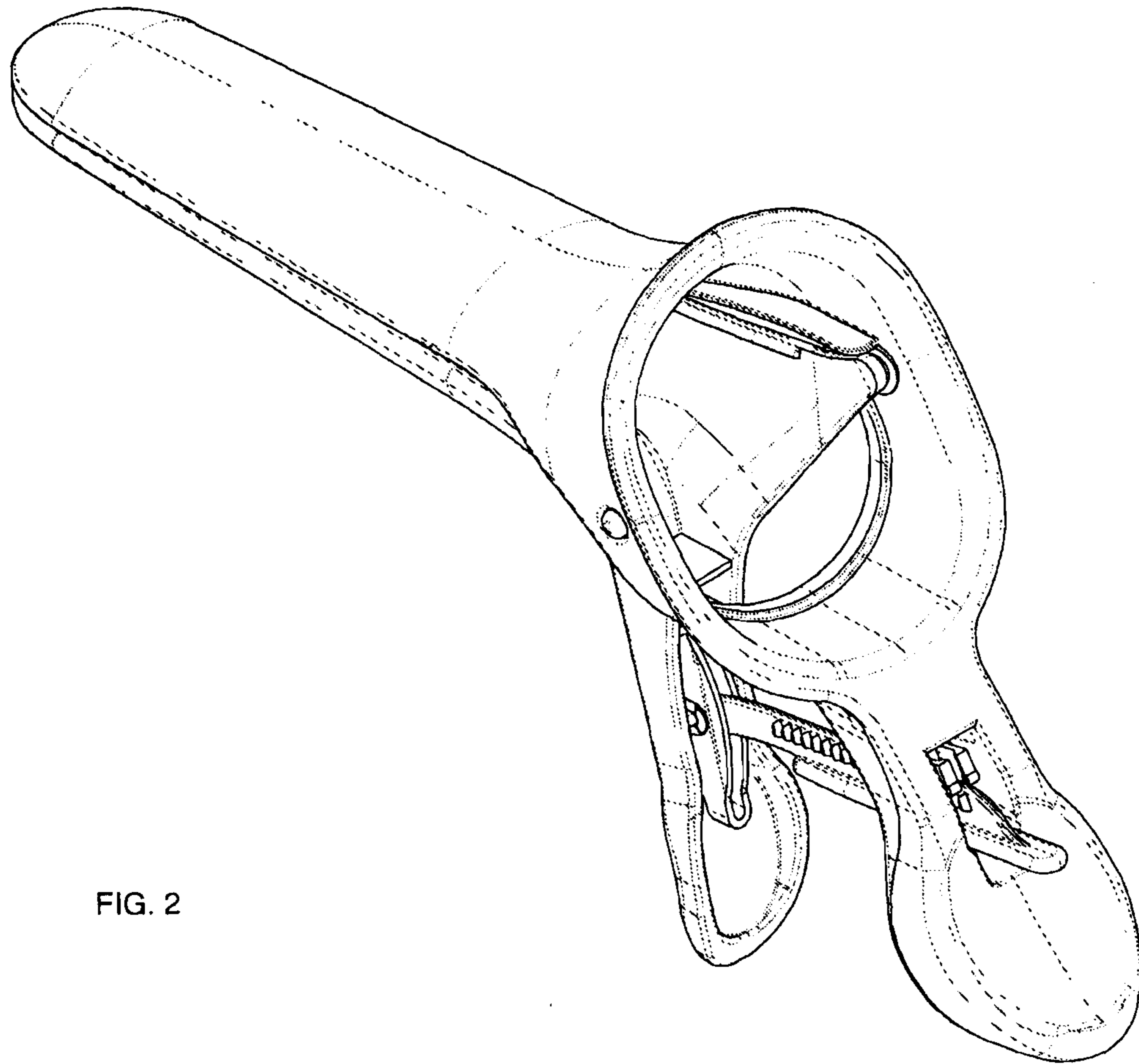

FIG. 2

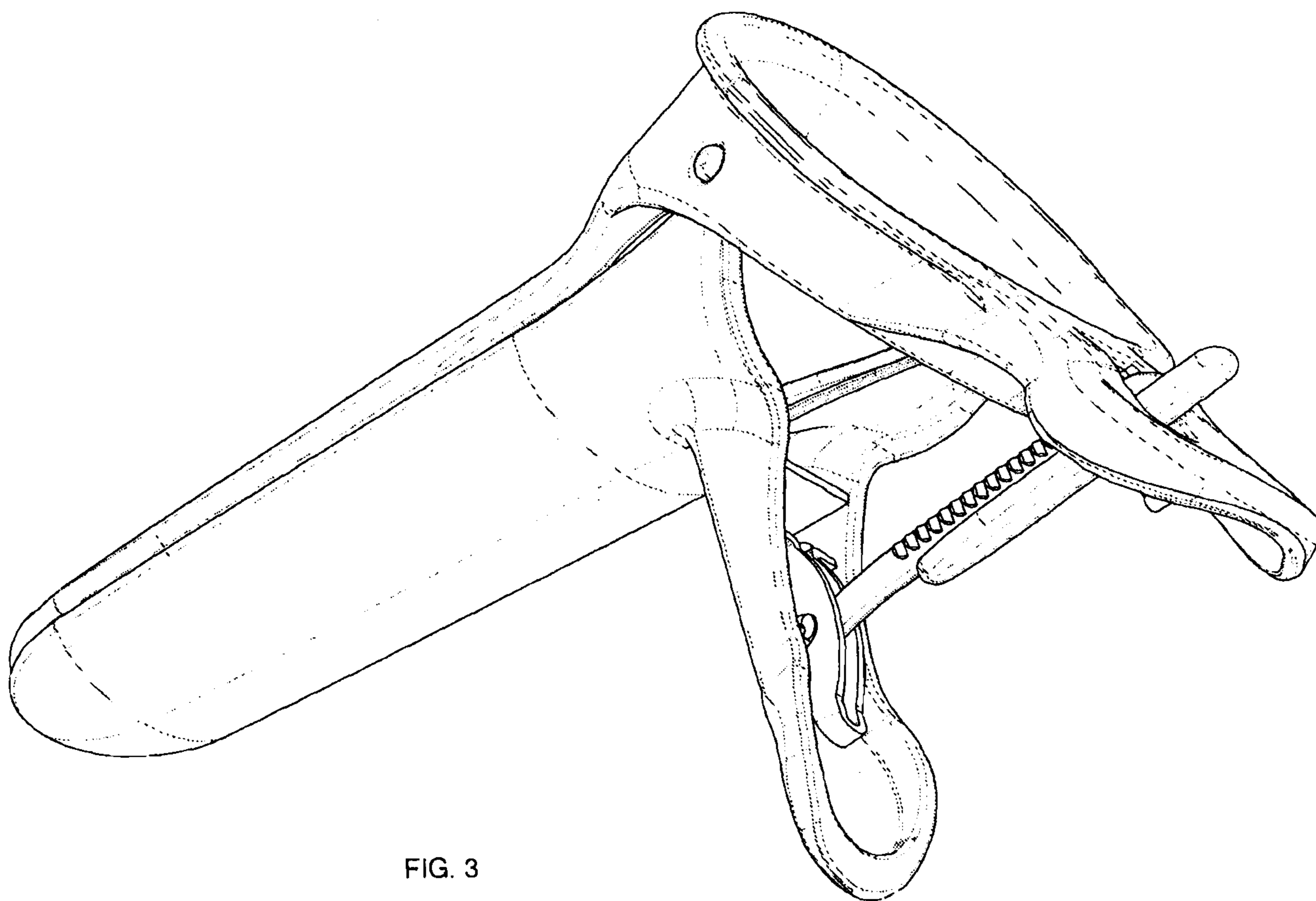

FIG. 3

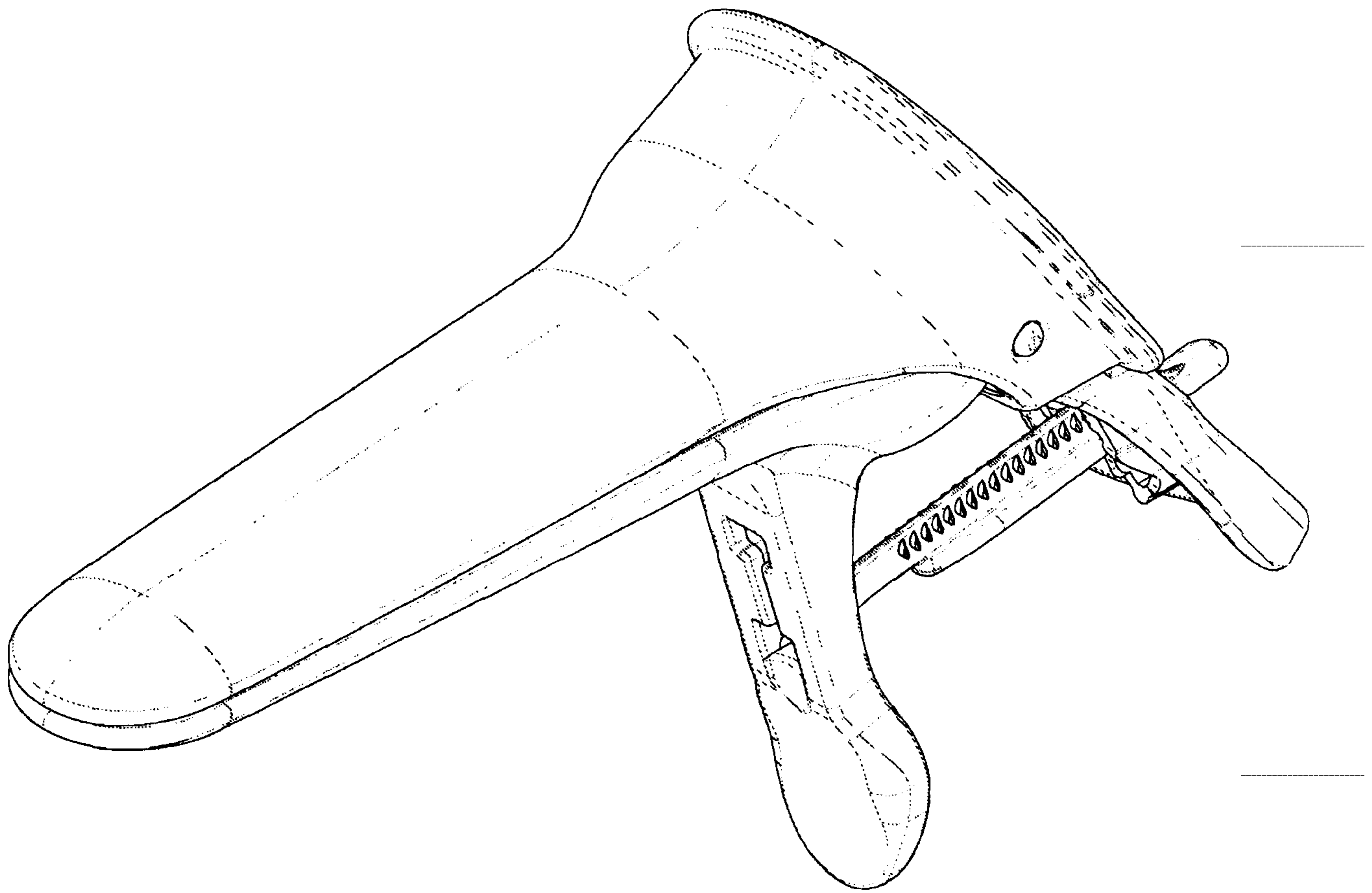

FIG. 4

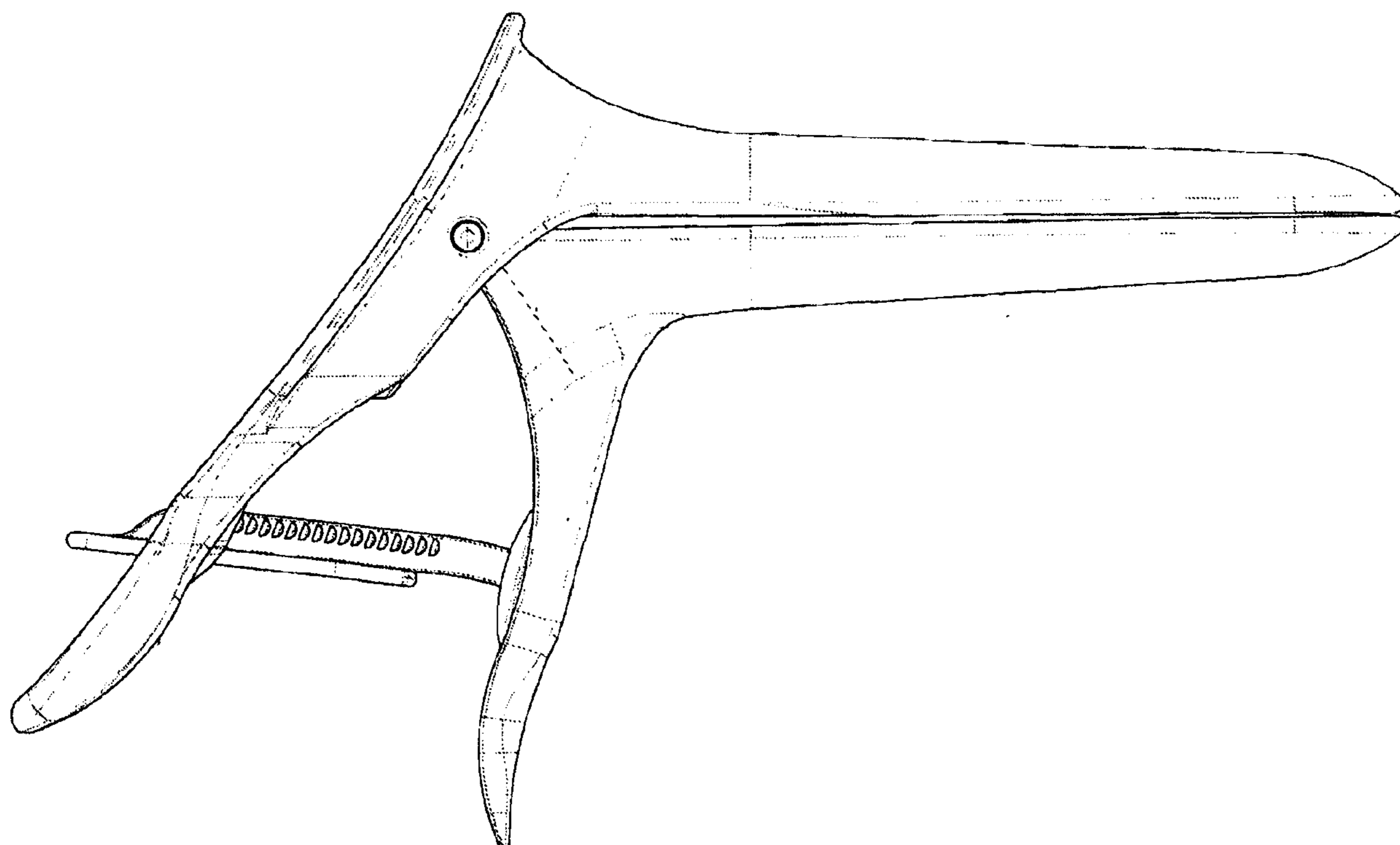

FIG. 5

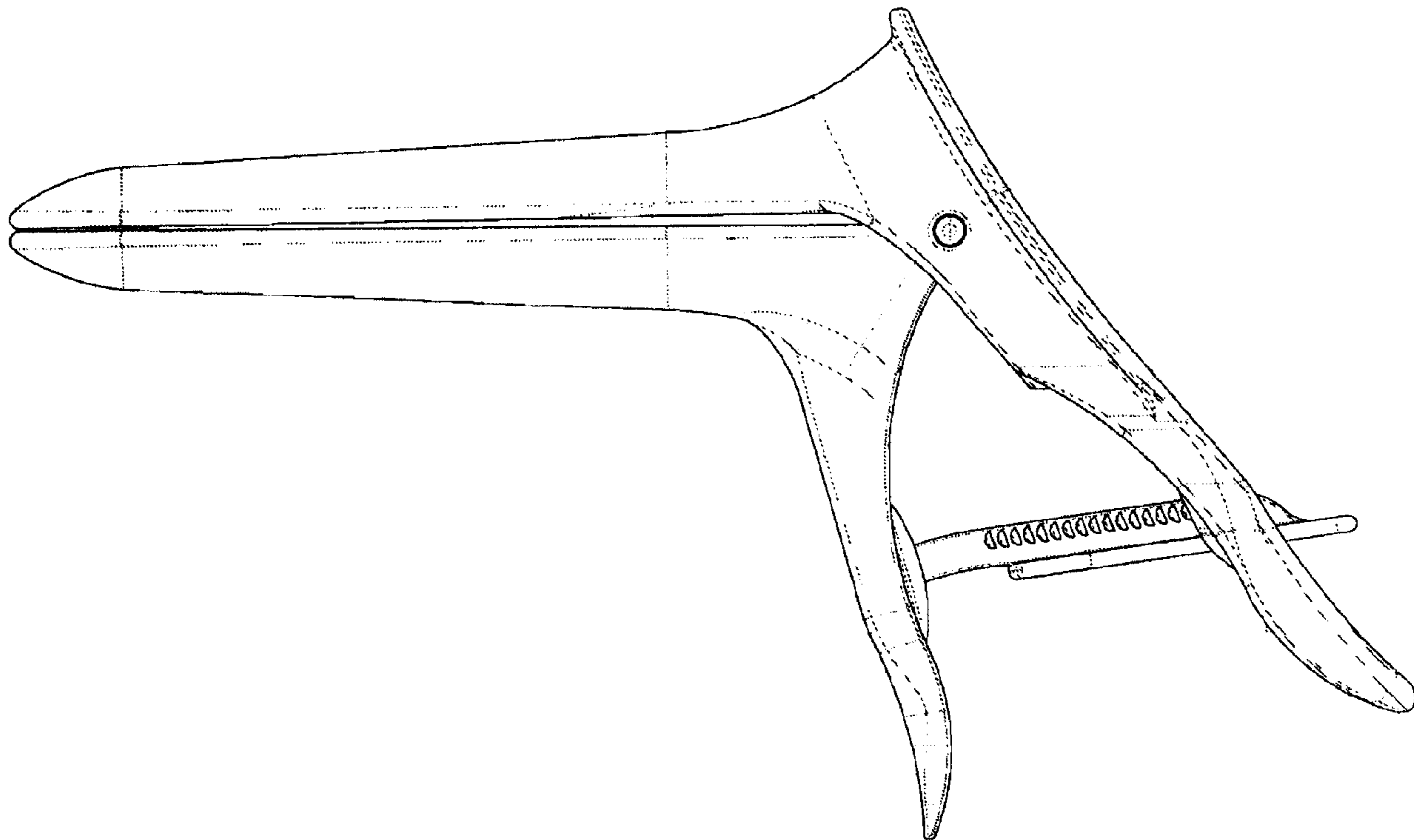

FIG. 6

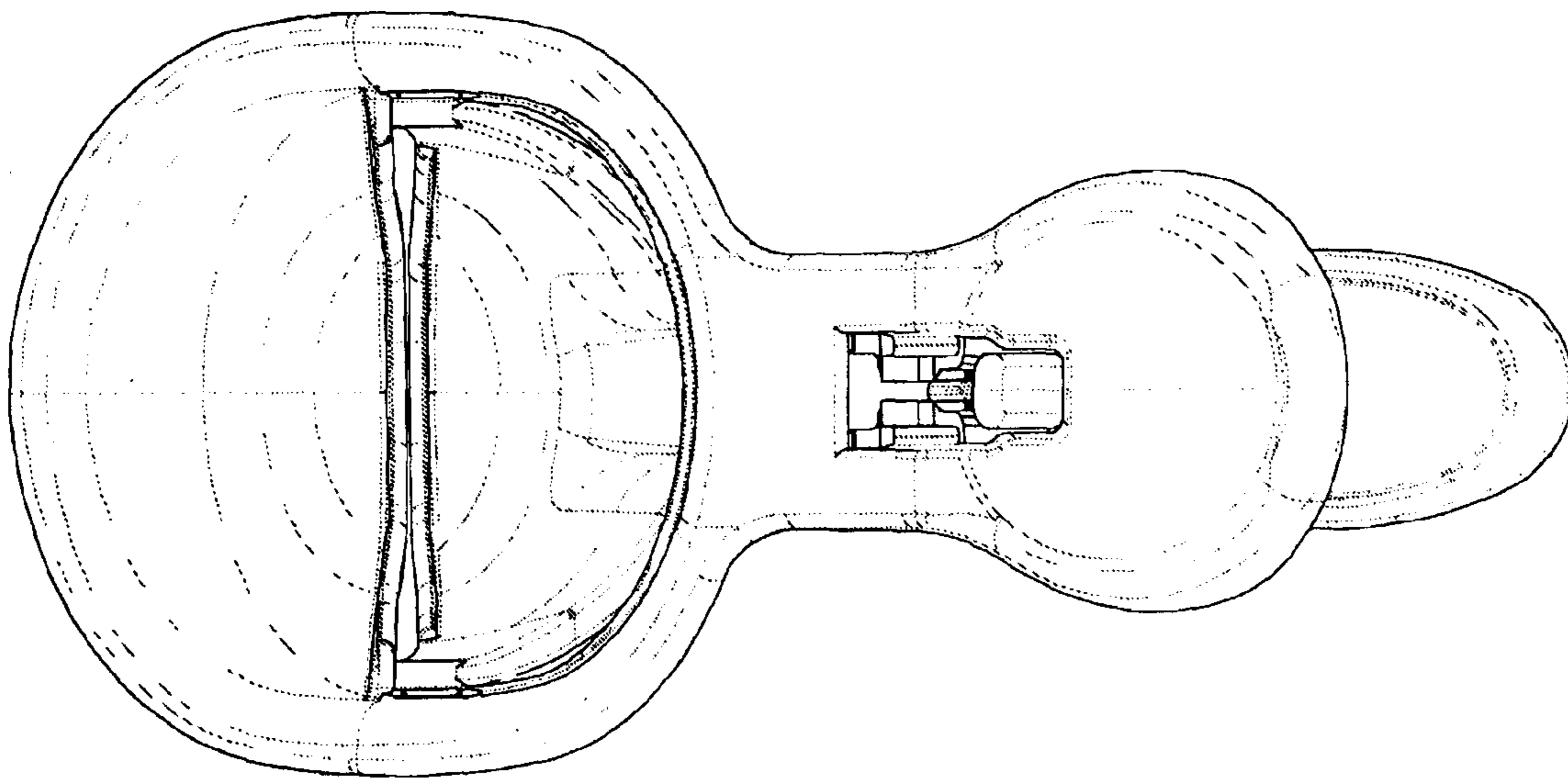

FIG. 7

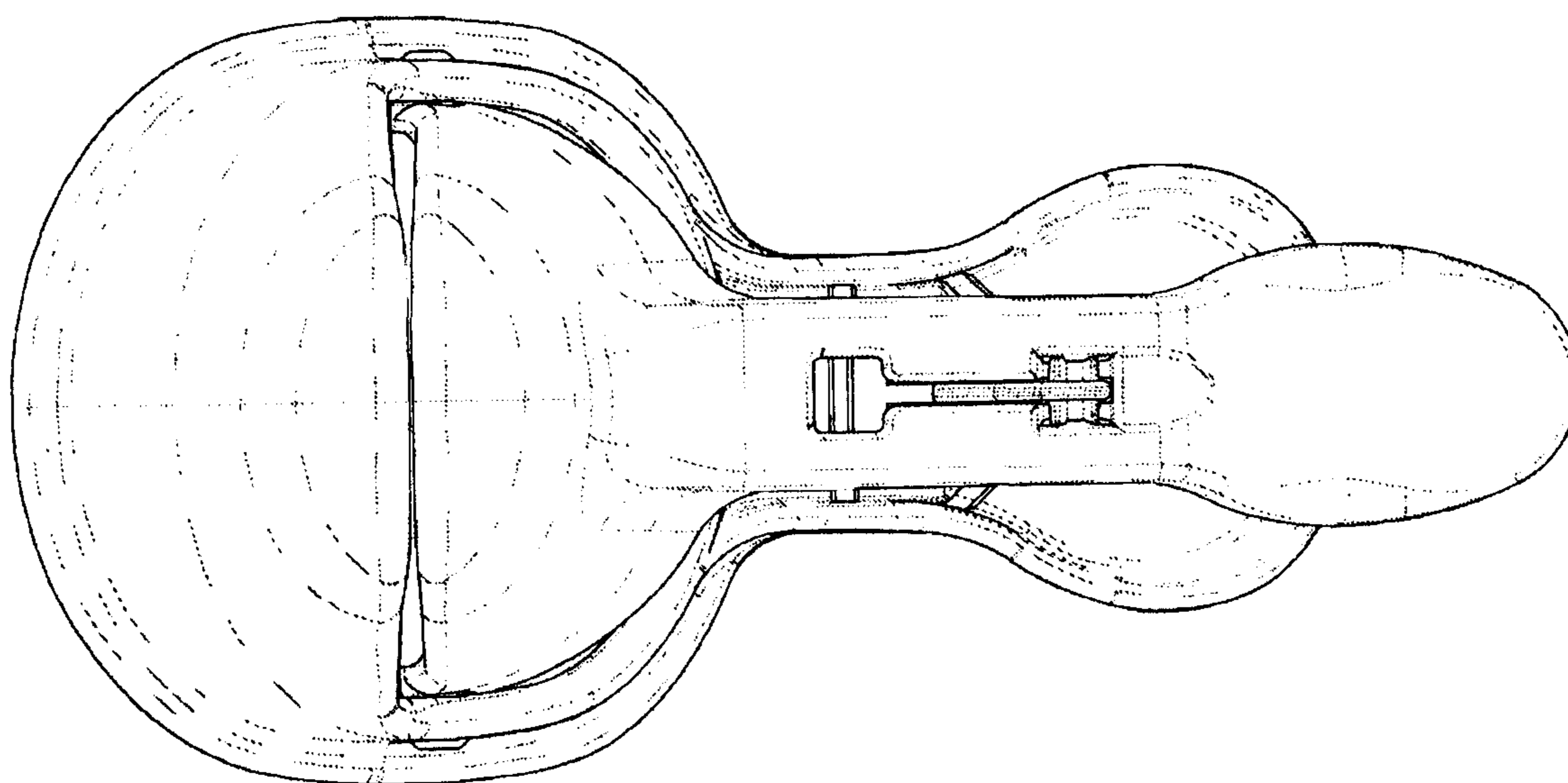

FIG. 8

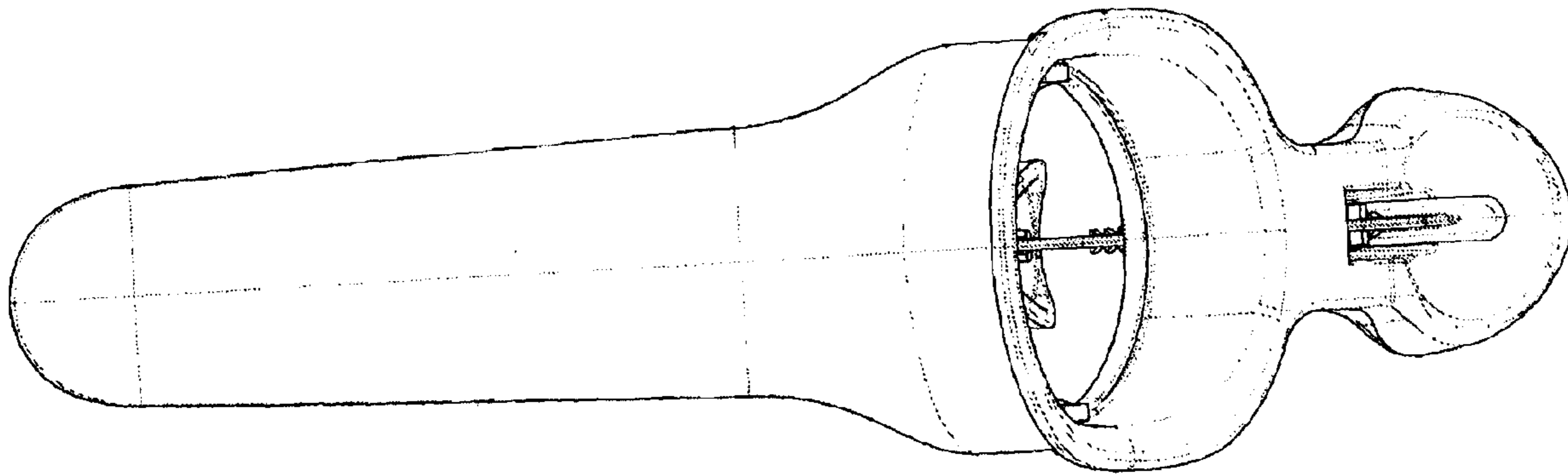

FIG. 9

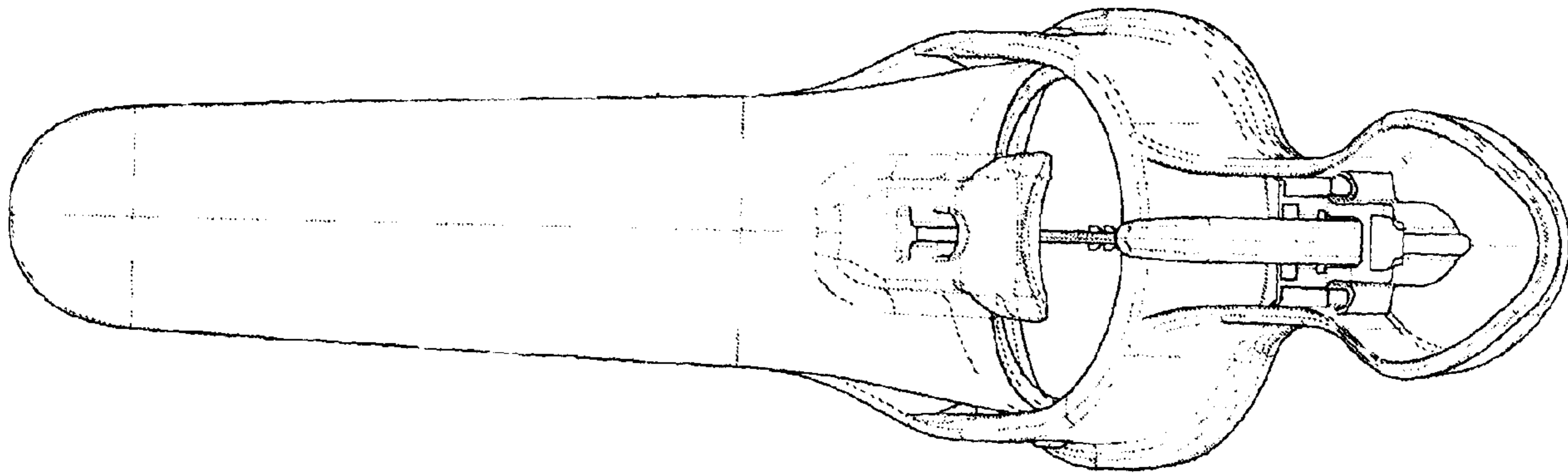

FIG. 10

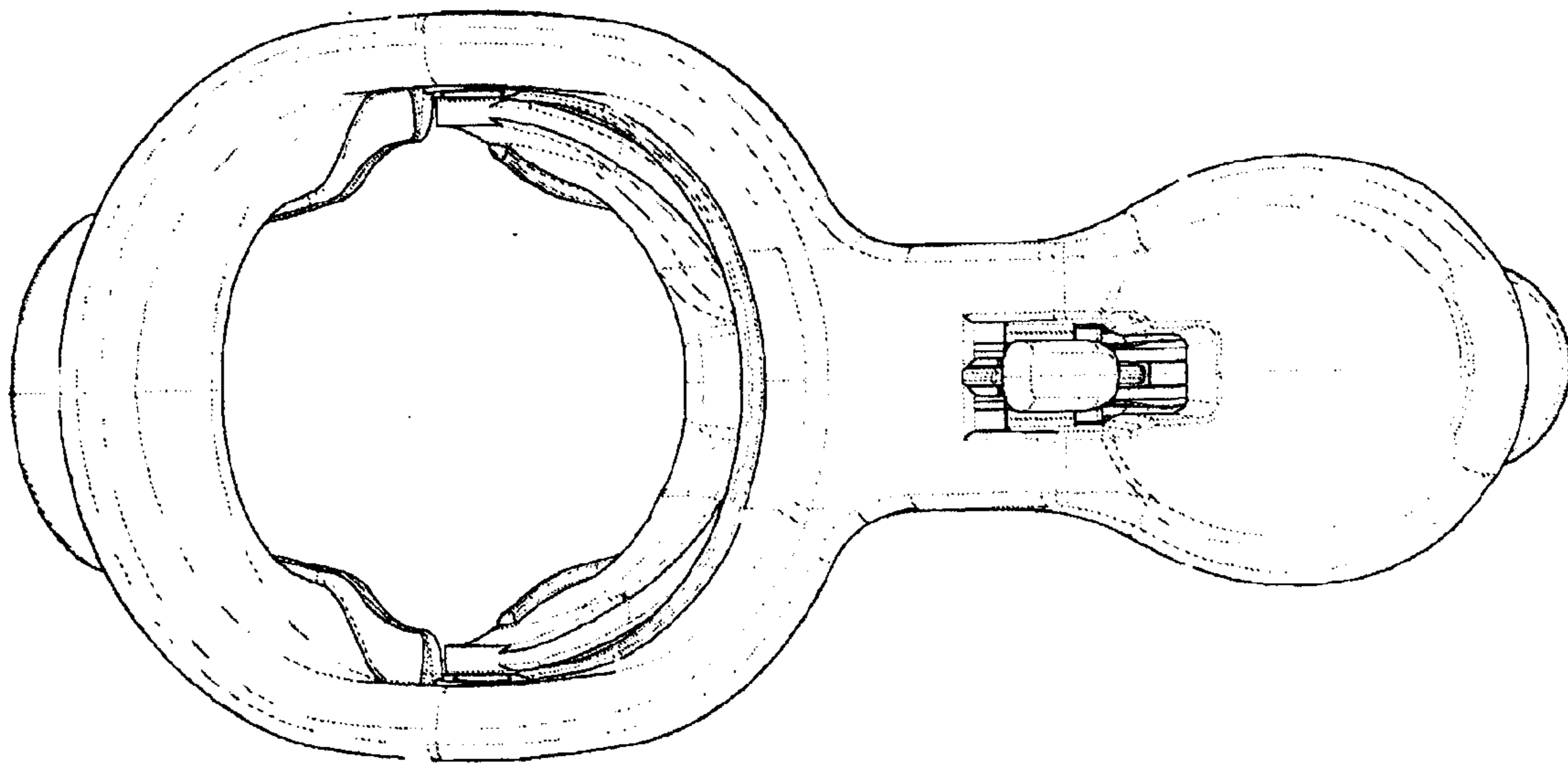

FIG. 11

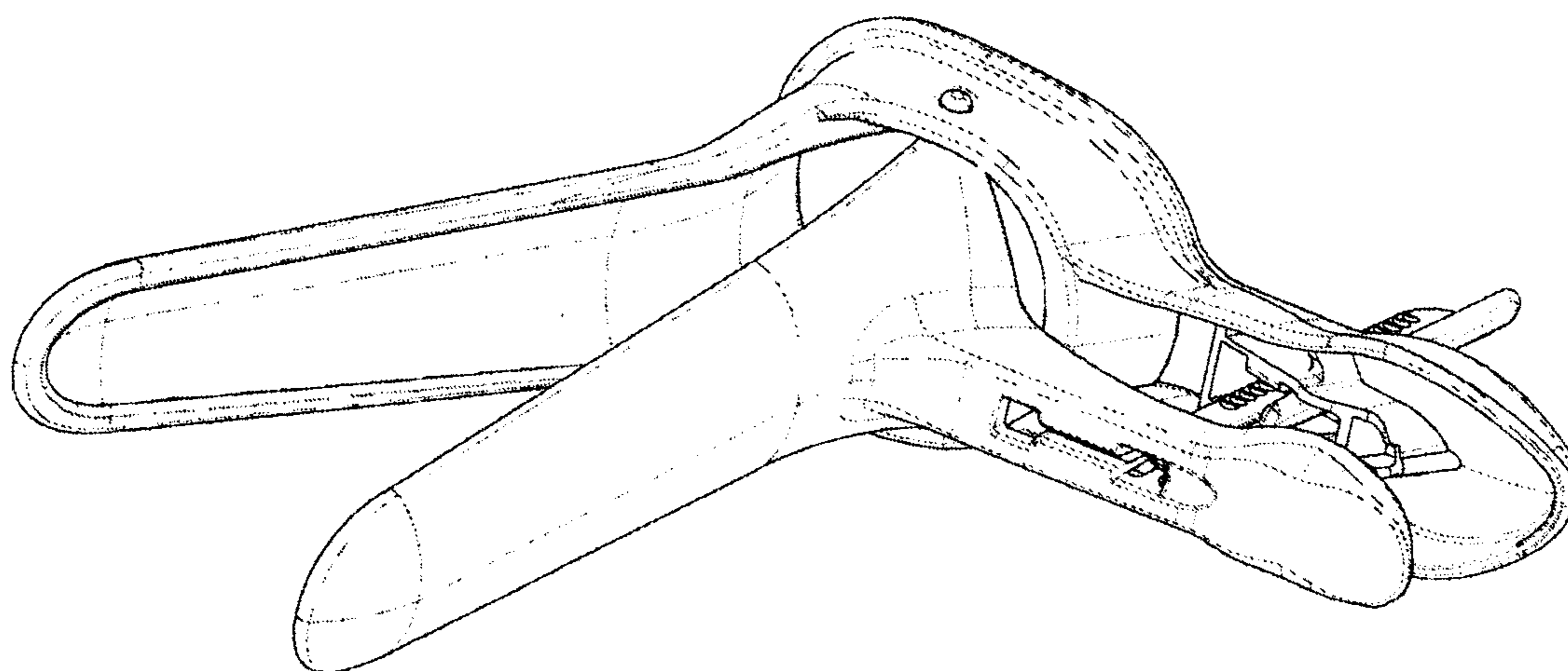

FIG. 12

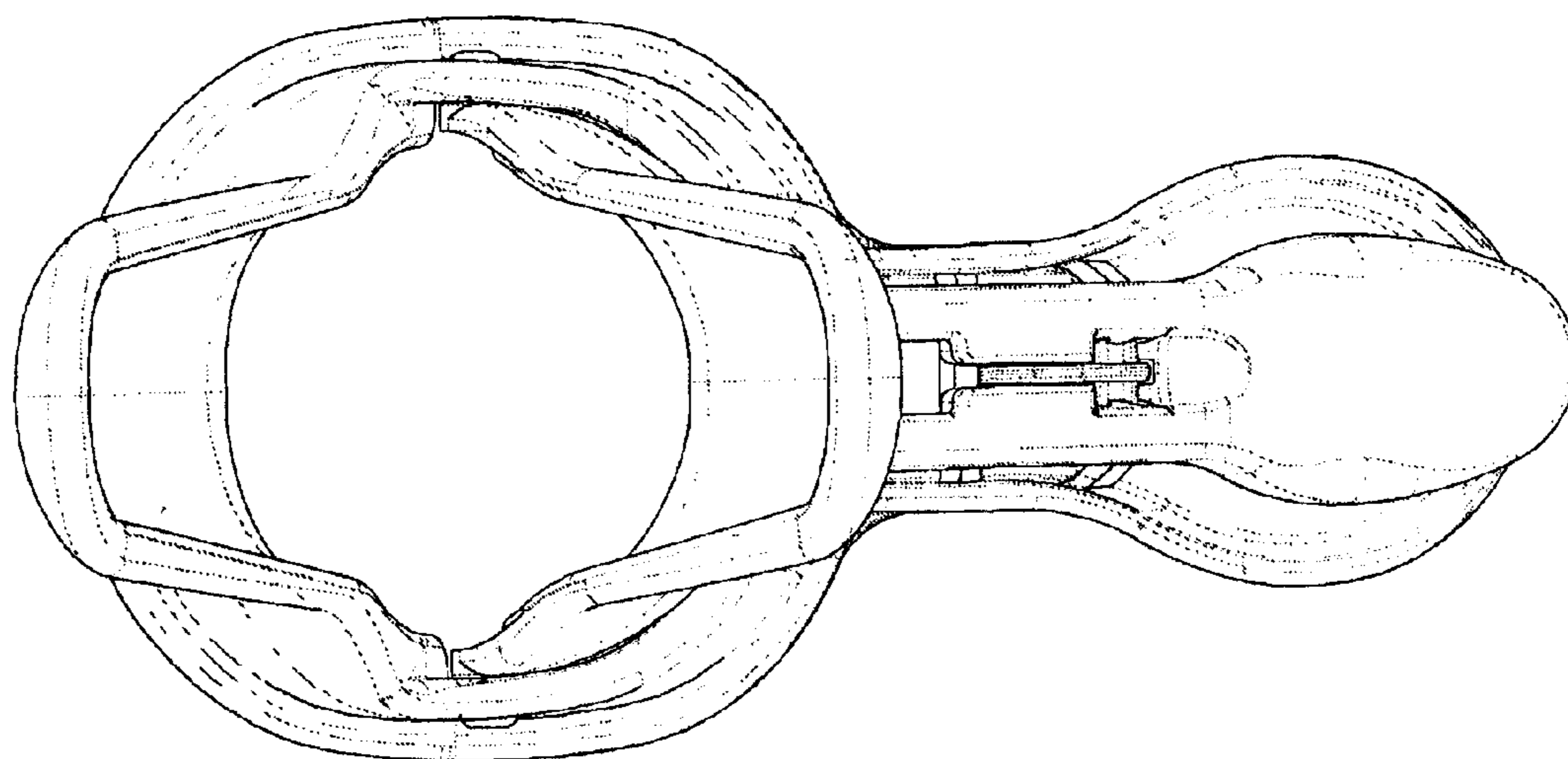

FIG. 13

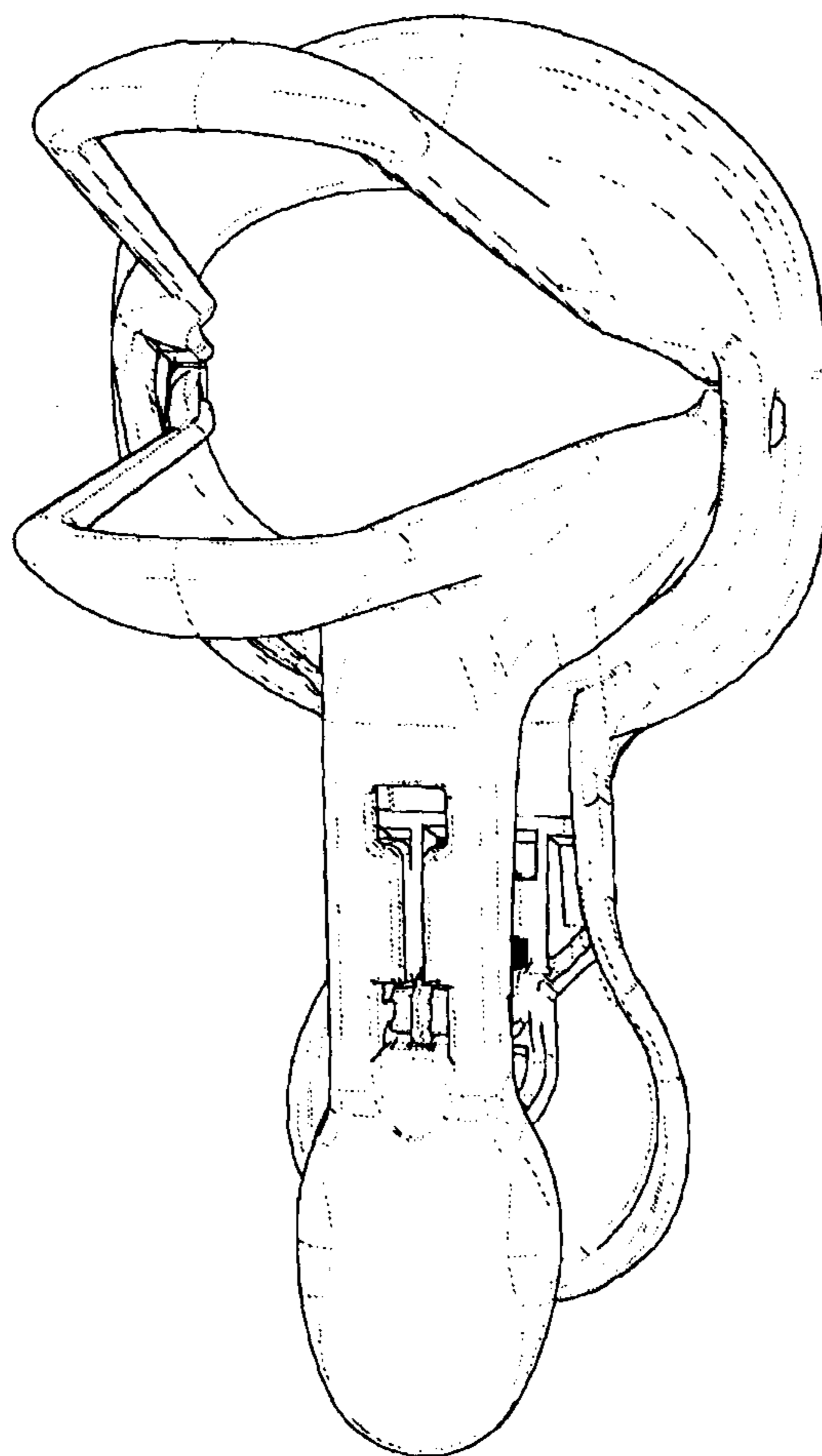

FIG. 14

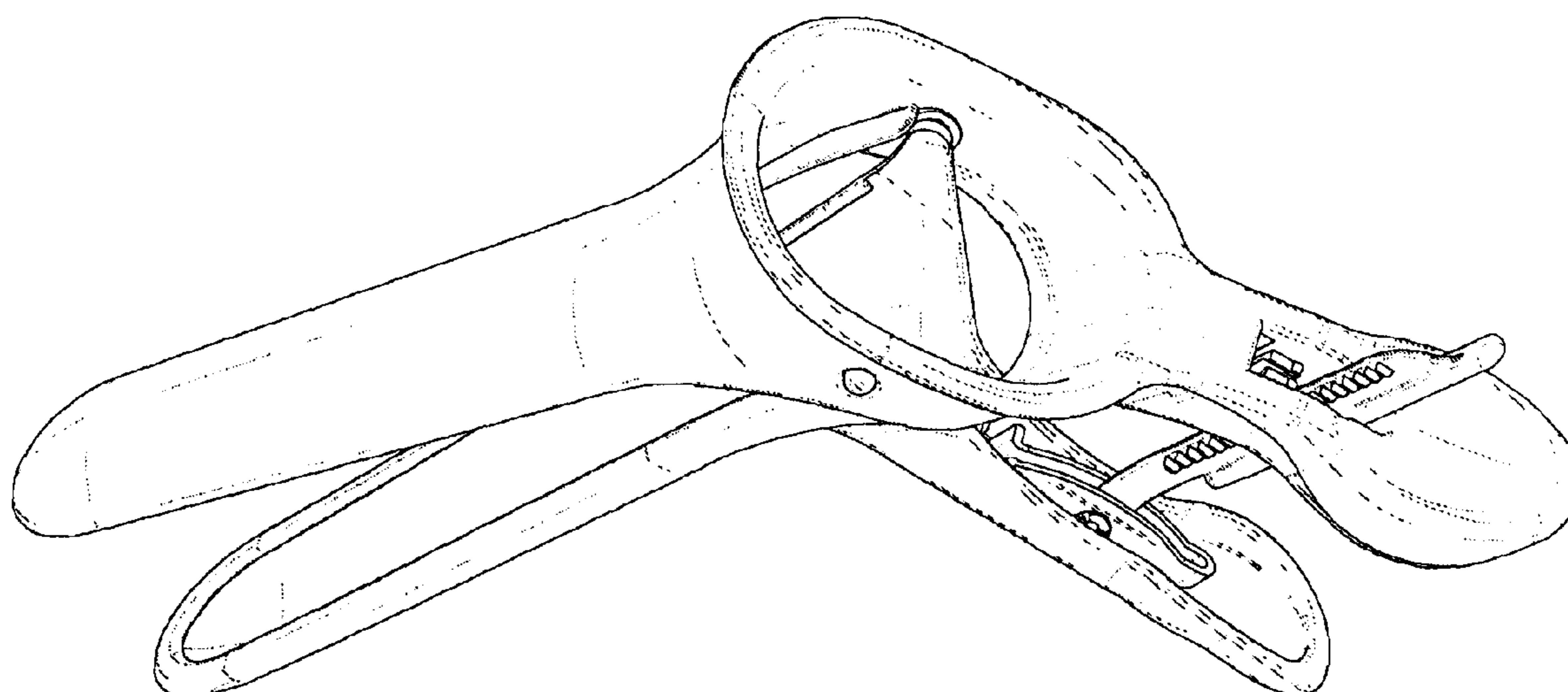

FIG. 15