



US00D710470S

(12) **United States Design Patent**
Trahan et al.

(10) **Patent No.:** **US D710,470 S**
(45) **Date of Patent:** **** Aug. 5, 2014**

(54) **GOLF CLUB HEAD**
(71) Applicant: **Dunlop Sports Company, Ltd.**, Kobe (JP)
(72) Inventors: **Nick Trahan**, Huntington Beach, CA (US); **Thomas Carlson**, Newport Beach, CA (US); **Chris Cooper**, Orange, CA (US); **Adam Sheldon**, Long Beach, CA (US)

D458,656 S 6/2002 Tang et al.
D461,514 S 8/2002 Tang et al.
D461,515 S 8/2002 Tang et al.
D461,860 S 8/2002 Tang
D461,861 S 8/2002 Tang et al.
D462,100 S 8/2002 Breier et al.
D463,002 S 9/2002 Tang et al.
6,471,600 B2 10/2002 Tang et al.
D467,985 S 12/2002 Breier et al.
D470,904 S 2/2003 Tang et al.
D471,245 S 3/2003 Tang et al.
D471,940 S 3/2003 Tang et al.
D472,594 S 4/2003 Tang et al.

(73) Assignee: **Dunlop Sports Co. Ltd.**, Kobe (JP)

(Continued)

(**) Term: **14 Years**

Primary Examiner — Mitchell Siegel

(21) Appl. No.: **29/460,383**

(74) Attorney, Agent, or Firm — Klein, O'Neill & Singh, LLP

(22) Filed: **Jul. 10, 2013**

(51) **LOC (10) Cl.** **21-02**

(52) **U.S. Cl.**
USPC **D21/759**

(58) **Field of Classification Search**
CPC A63B 53/065; A63B 53/0487
USPC D21/736-746, 759; 473/324-331, 473/251-256, 340-341
See application file for complete search history.

(57) **CLAIM**

The ornamental design for a golf club head, as shown and described.

DESCRIPTION

FIG. 1 is a top plan view of a golf club head according to the present design;
FIG. 2 is a front elevation view of the golf club head of FIG. 1;
FIG. 3 is a bottom plan view of the golf club head of FIG. 1;
FIG. 4 is a rear elevation view of the golf club head of FIG. 1;
FIG. 5 is a side elevation view of the golf club head of FIG. 1, taken from the right side of FIG. 1;
FIG. 6 is a side elevation view of the golf club head of FIG. 1, taken from the left side of FIG. 1; and,
FIG. 7 is a perspective view of the golf club head of FIG. 1, taken from the top, front, and right side of FIG. 1.
The phantom lining illustrates environmental structure that forms no part of the claimed design.

(56) **References Cited**

U.S. PATENT DOCUMENTS

D401,636 S 11/1998 Duclos
D429,297 S 8/2000 Hettinger
D441,042 S 4/2001 Hettinger
D443,320 S 6/2001 Breier et al.
D443,906 S 6/2001 Hettinger et al.
D444,194 S * 6/2001 Calabro D21/738
6,273,831 B1 8/2001 Dewanjee
D447,782 S 9/2001 Hettinger et al.
D449,085 S 10/2001 Breier et al.
D457,586 S 5/2002 Tang et al.

1 Claim, 4 Drawing Sheets

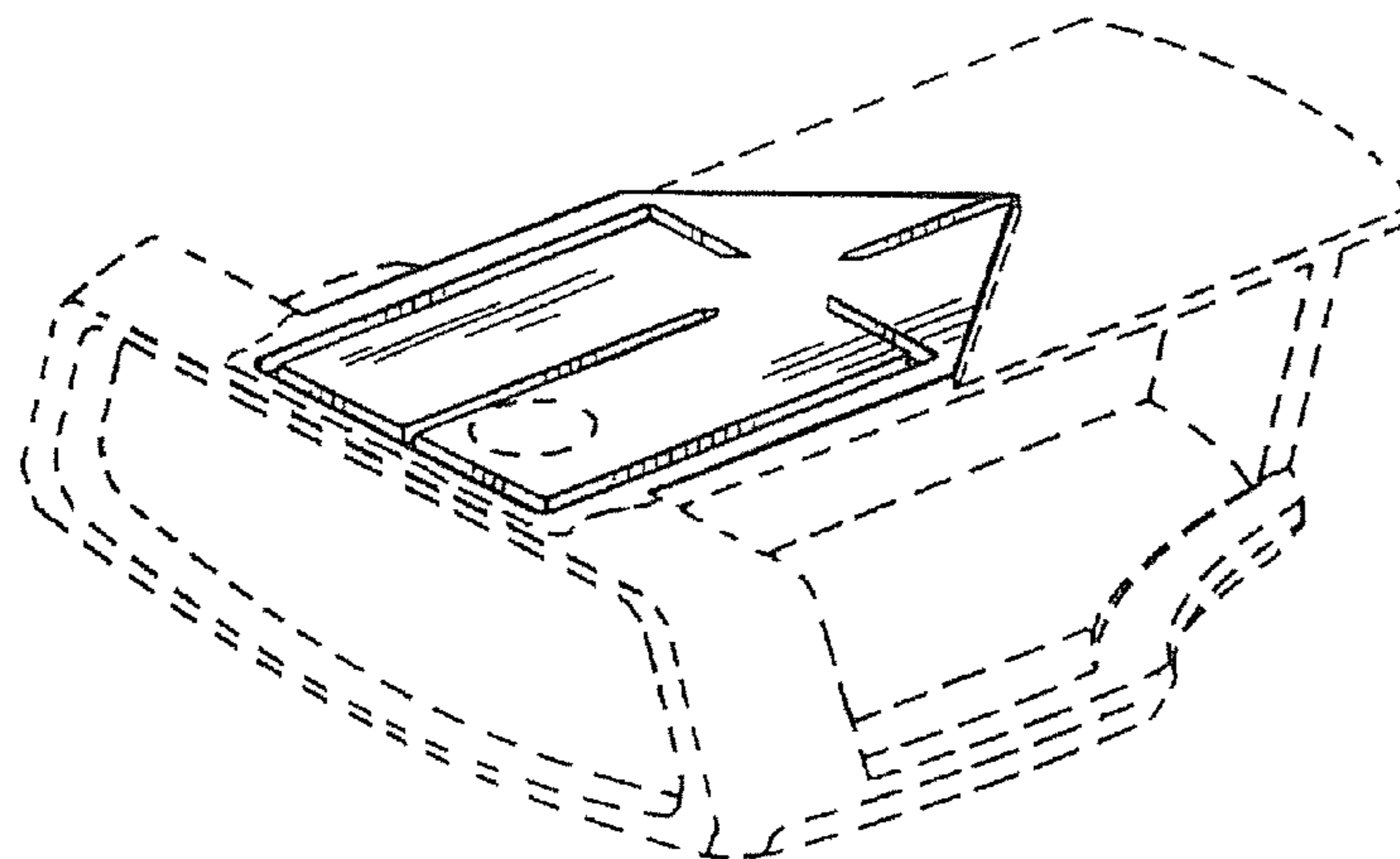

(56)

References Cited

U.S. PATENT DOCUMENTS

D472,595 S	4/2003	Tang et al.	
D481,089 S *	10/2003	Breier et al.	D21/738
D484,207 S *	12/2003	Swift	D21/742
D485,320 S	1/2004	Breier et al.	
D485,321 S *	1/2004	Breier et al.	D21/738
D485,323 S	1/2004	Wagner et al.	
D485,592 S	1/2004	Hettinger et al.	
6,679,782 B2	1/2004	Tang et al.	
D486,194 S	2/2004	Helmstetter et al.	
D488,200 S	4/2004	Olsavsky et al.	
D496,417 S *	9/2004	Tang	D21/738
D496,418 S *	9/2004	Tang et al.	D21/738
6,793,588 B2	9/2004	Tang et al.	
D505,703 S	5/2005	Fiskari	
D506,237 S	6/2005	Byrne et al.	
6,905,420 B2	6/2005	Tang et al.	
D508,546 S	8/2005	Oldknow	
D508,723 S	8/2005	Rollinson et al.	
6,929,564 B2	8/2005	Olsavsky et al.	
D510,394 S *	10/2005	Tang et al.	D21/742
6,960,140 B2	11/2005	Solheim et al.	
6,974,394 B1	12/2005	Tang et al.	
D513,777 S	1/2006	Cuellar	
D514,182 S	1/2006	Olsavsky et al.	
D515,647 S	2/2006	Morgulis	
D517,143 S	3/2006	Petsel et al.	
D519,180 S	4/2006	Oldknow	
D520,583 S	5/2006	Rollinson et al.	
7,052,411 B2	5/2006	Solheim et al.	
7,070,516 B2	7/2006	Dewanjee et al.	
7,086,957 B2	8/2006	Solheim et al.	
D532,066 S	11/2006	Tang	
D532,467 S	11/2006	Aguinaldo et al.	
D532,844 S	11/2006	Rollinson	
D532,845 S	11/2006	Rollinson	
D532,847 S	11/2006	Rollinson	
D533,242 S	12/2006	Tang	
D533,244 S	12/2006	Kroll, Jr.	
D533,613 S	12/2006	Byrne et al.	
D533,913 S	12/2006	Byrne et al.	
7,147,569 B2	12/2006	Tang et al.	
D534,974 S	1/2007	Haack	
7,166,036 B2	1/2007	Byrne et al.	
7,169,061 B2	1/2007	Hou	
7,232,379 B2	6/2007	Riseley	
D548,295 S	8/2007	Jertson et al.	
D548,296 S	8/2007	Rollinson	
D549,795 S	8/2007	Rollinson	
D552,197 S	10/2007	Wells et al.	
D552,699 S	10/2007	Rollinson	
D552,700 S	10/2007	Rollinson	
D557,361 S	12/2007	Rollinson	
D559,930 S *	1/2008	Cameron	D21/746
D561,282 S	2/2008	Rollinson	
D561,854 S *	2/2008	Morris	D21/744
D562,926 S	2/2008	Roberts et al.	
D564,606 S	3/2008	Oldknow et al.	
7,344,451 B2	3/2008	Tang et al.	
D565,681 S	4/2008	Tanaka	
D568,427 S	5/2008	Nguyen et al.	
D569,462 S	5/2008	Rollinson	
D571,878 S	6/2008	Jones et al.	
D572,331 S	7/2008	Oldknow et al.	
D572,780 S	7/2008	Rollinson	
D573,673 S	7/2008	Noyes	
D574,908 S	8/2008	Hettinger et al.	
D575,366 S	8/2008	Rollinson	
D577,085 S	9/2008	Nicolette et al.	
D577,398 S	9/2008	Hilton	
D579,995 S	11/2008	Nicolette et al.	
D581,477 S	11/2008	Burdick	
D582,497 S	12/2008	Rollinson	
D588,657 S	3/2009	Hettinger et al.	
D589,575 S	3/2009	Kim et al.	
D590,034 S	4/2009	Foster et al.	
D590,035 S *	4/2009	Hilton	D21/744
D590,461 S	4/2009	Kim et al.	
D590,462 S	4/2009	Hettinger et al.	
D591,371 S	4/2009	Hilton	
D591,372 S	4/2009	Tang et al.	
D591,806 S	5/2009	Cameron	
D591,807 S	5/2009	Rollinson	
D592,717 S	5/2009	Rollinson	
D594,517 S	6/2009	Tang et al.	
D595,372 S	6/2009	Rollinson	
D595,373 S	6/2009	Kim et al.	
7,540,810 B2	6/2009	Hettinger et al.	
D595,793 S	7/2009	Rollinson	
D599,425 S	9/2009	Laub	
D603,006 S	10/2009	Foster et al.	
D603,471 S *	11/2009	Mantelli	D21/736
D616,513 S	5/2010	Feret	
D619,665 S	7/2010	Rollinson et al.	
D626,191 S *	10/2010	Hilton	D21/744
D629,475 S *	12/2010	Rollinson	D21/736
D630,690 S	1/2011	Rollinson	
D634,801 S	3/2011	Rollinson	
D635,625 S	4/2011	Rollinson	
D638,892 S	5/2011	Hettinger et al.	
D640,341 S	6/2011	Foster et al.	
D641,057 S	7/2011	Rollinson	
D641,438 S	7/2011	Rollinson	
D641,439 S	7/2011	Rollinson et al.	
D641,440 S	7/2011	Hettinger et al.	
D641,441 S	7/2011	Hilton et al.	
D641,442 S	7/2011	Rollinson	
D641,814 S	7/2011	Hilton et al.	
D641,815 S	7/2011	Rollinson et al.	
D641,816 S	7/2011	Rollinson et al.	
D643,487 S *	8/2011	Serrano et al.	D21/742
D650,459 S	12/2011	Rollinson	
2010/0173720 A1	7/2010	Kim	

* cited by examiner

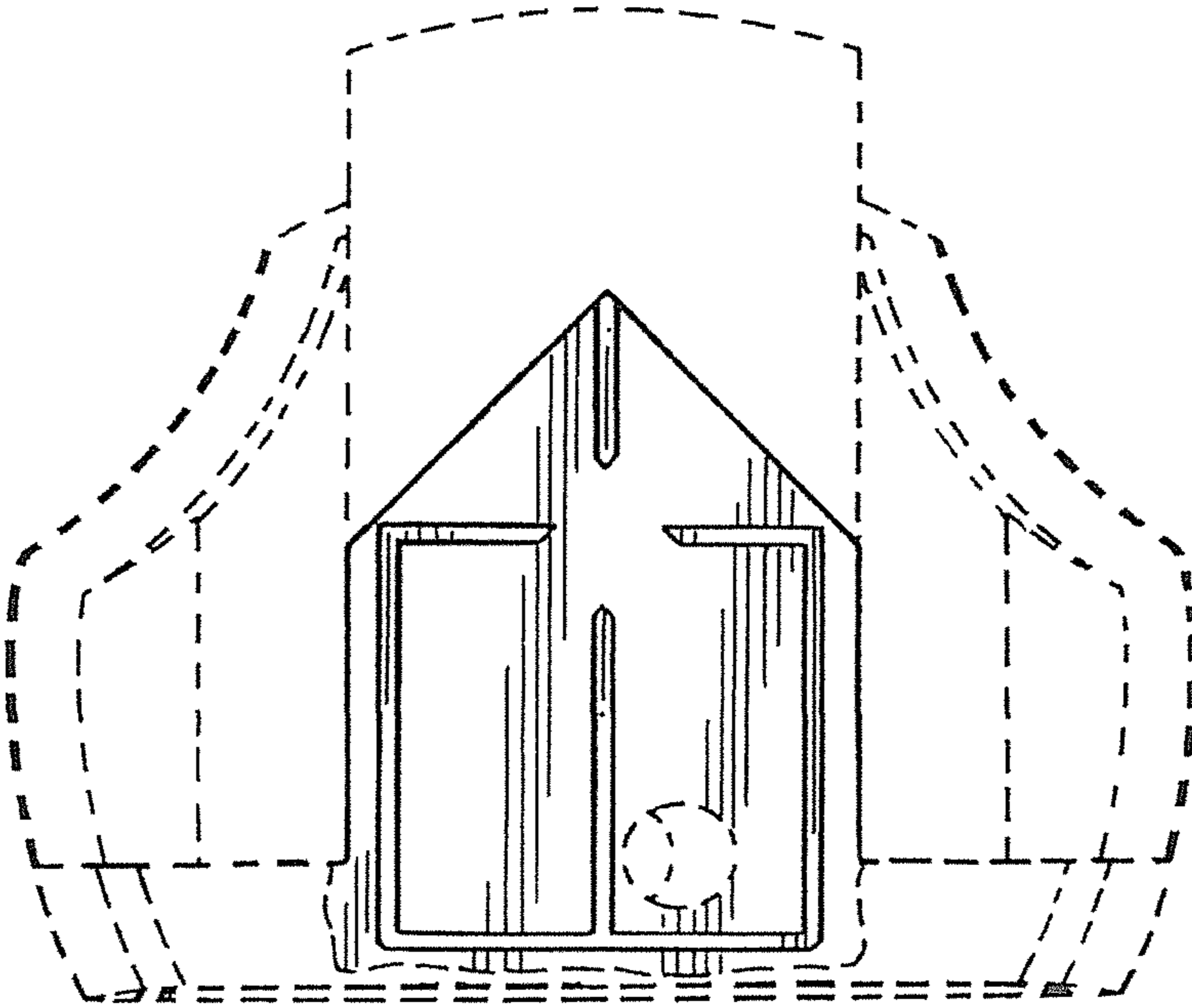

FIG. 1

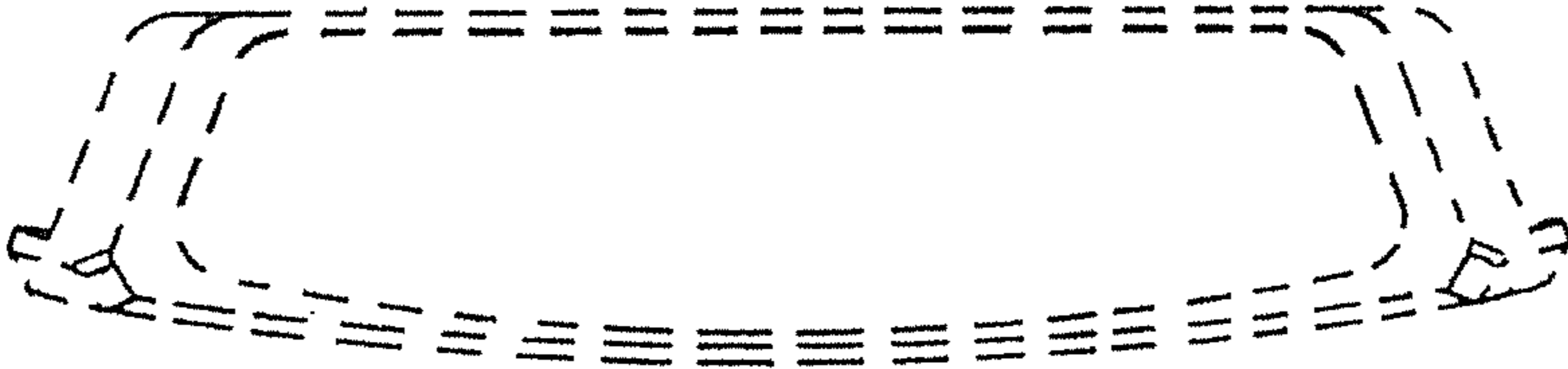

FIG. 2

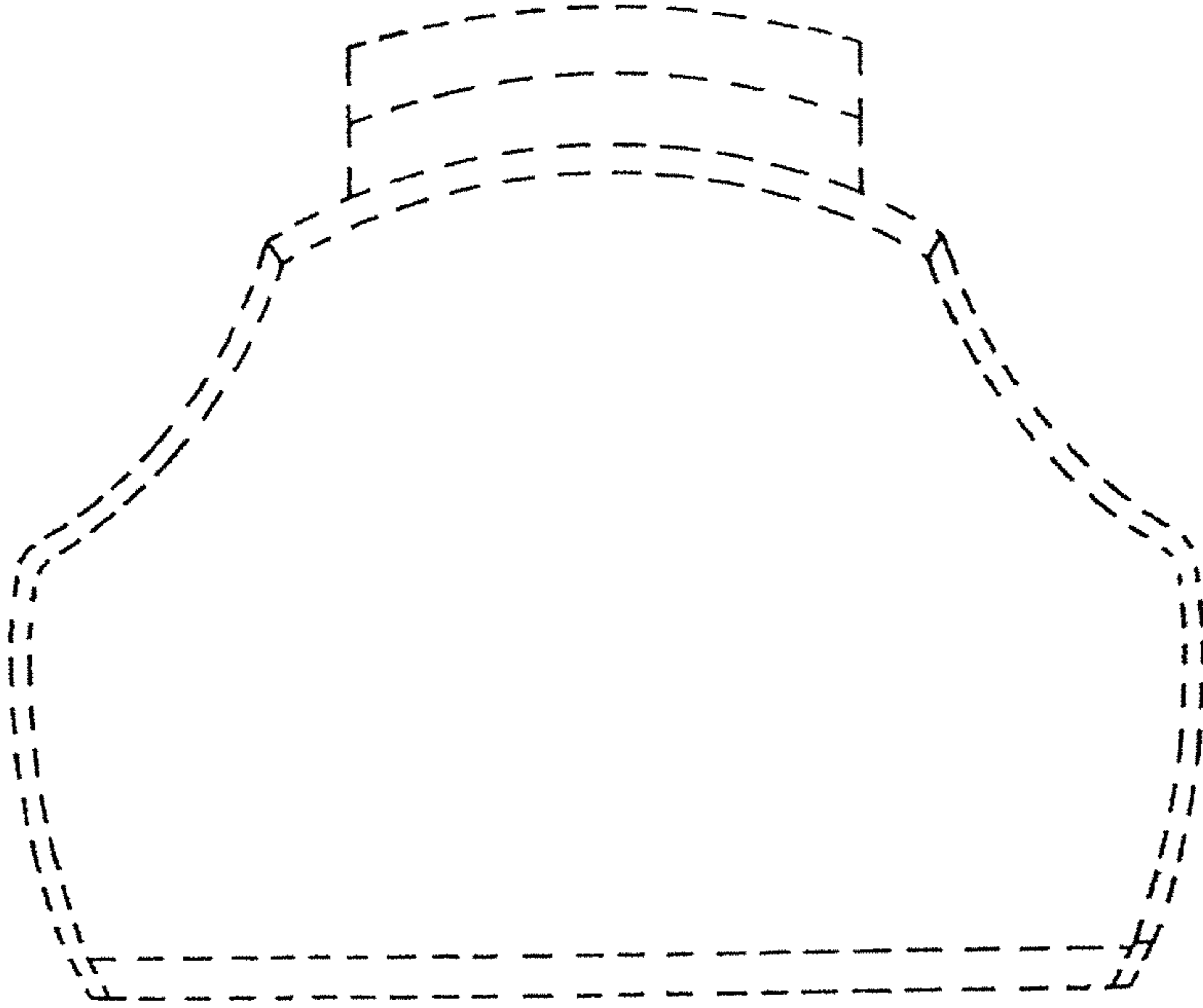

FIG. 3

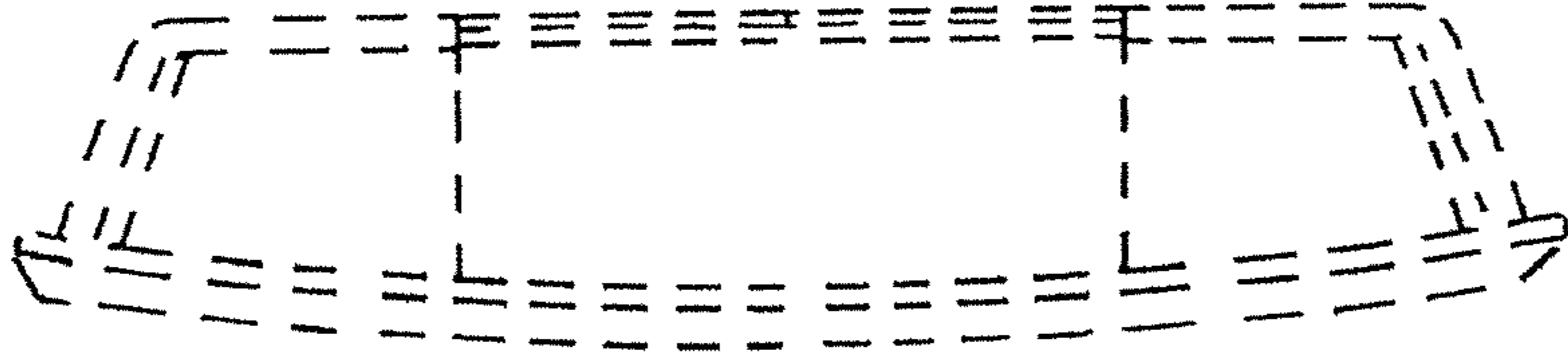

FIG. 4

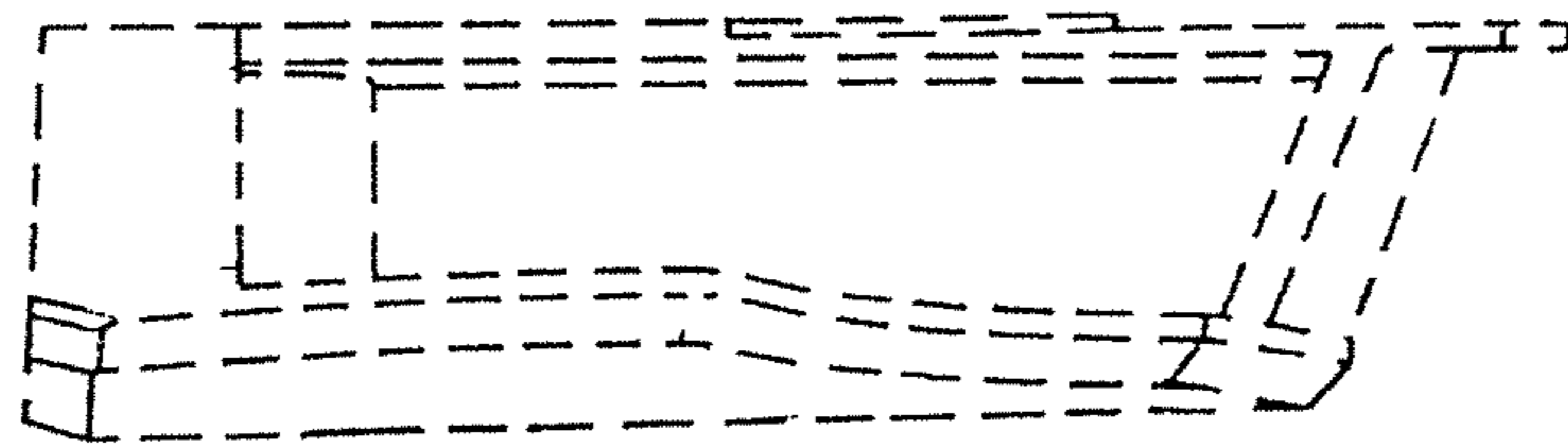

FIG. 5

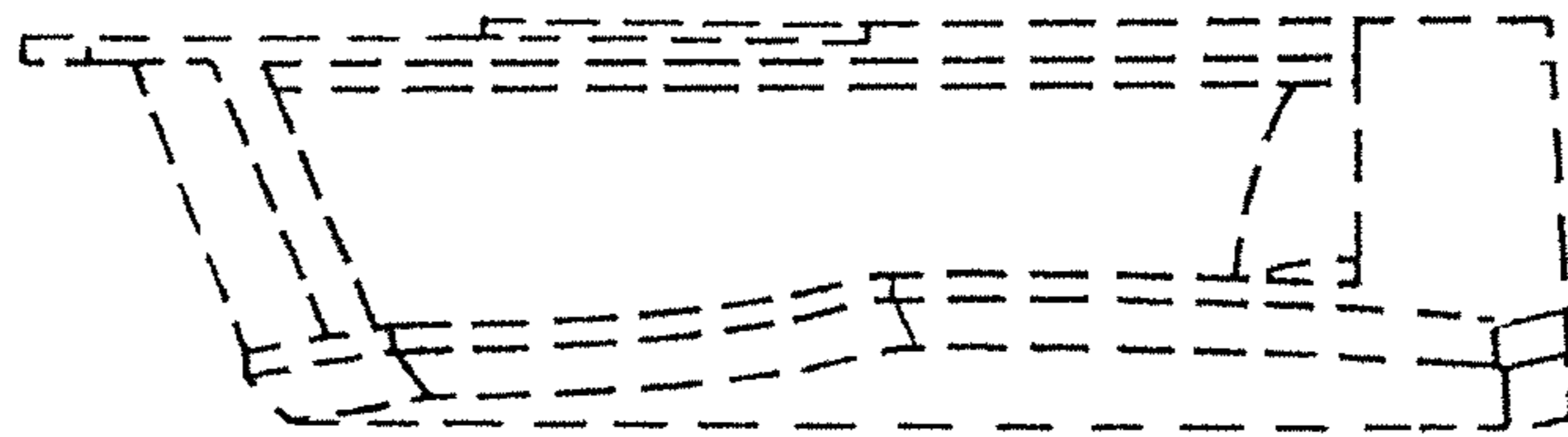

FIG. 6

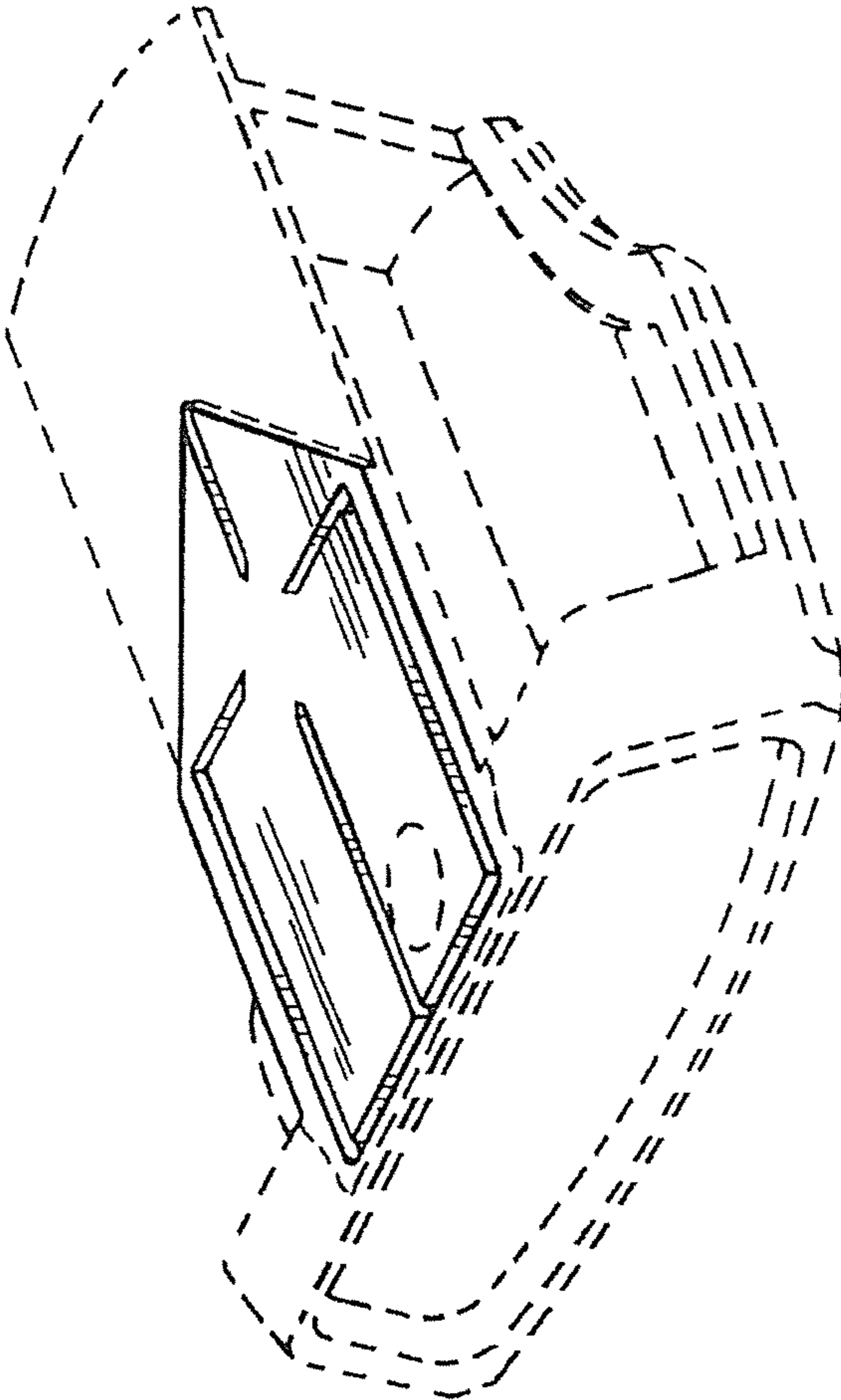

FIG. 7