



US00D710438S

(12) **United States Design Patent**
Kano et al.

(10) **Patent No.:** **US D710,438 S**

(45) **Date of Patent:** **** Aug. 5, 2014**

(54) **PRINTER**

(71) Applicant: **Seiko Epson Corporation**, Tokyo (JP)

(72) Inventors: **Tomohisa Kano**, Shiojiri (JP); **Ayumu Nakamura**, Matsumoto (JP); **Hiroto Miyauchi**, Matsumoto (JP); **Takaaki Inui**, Matsumoto (JP)

(73) Assignee: **Seiko Epson Corporation**, Tokyo (JP)

(**) Term: **14 Years**

(21) Appl. No.: **29/445,514**

(22) Filed: **Feb. 13, 2013**

(30) **Foreign Application Priority Data**

Sep. 7, 2012 (JP) 2012-021599

(51) **LOC (10) Cl.** **14-02**

(52) **U.S. Cl.**
USPC **D18/50**

(58) **Field of Classification Search**
USPC D18/14, 19, 36-39, 50, 54, 54.1, 55;
D14/420-425, 463-470; 400/613,
400/613.1-613.4, 690.1-690.4, 691-694

See application file for complete search history.

(56) **References Cited**

U.S. PATENT DOCUMENTS

D294,357	S	*	2/1988	Klein et al.	D18/55
5,528,278	A	*	6/1996	Takizawa et al.	D18/50
D428,051	S	*	7/2000	Ikenaga	D1/50
D528,151	S	*	9/2006	Hattori	D18/50
D544,530	S		6/2007	Omuro et al.		
D579,043	S	*	10/2008	Hattori et al.	D18/50
D585,065	S	*	1/2009	Kuroda	D14/425
D615,982	S	*	5/2010	Sugitani et al.	D14/425
D641,394	S	*	7/2011	Inada	D18/50
D685,024	S	*	6/2013	Shibui et al.	D18/50

* cited by examiner

Primary Examiner — Cathy A MacCormac

(57) **CLAIM**

The ornamental design for a printer, as shown and described.

DESCRIPTION

FIG. 1 is a front, top and right side perspective view of a printer showing our new design;
FIG. 2 is a rear, top and left side perspective view thereof;
FIG. 3 is a front view thereof;
FIG. 4 is a rear view thereof;
FIG. 5 is a left side view thereof;
FIG. 6 is a right side view thereof;
FIG. 7 is a top plan view thereof; and,
FIG. 8 is a bottom plan view thereof.

The features shown in broken lines in the drawings depict environmental subject matter only and form no part of the claimed design.

1 Claim, 8 Drawing Sheets

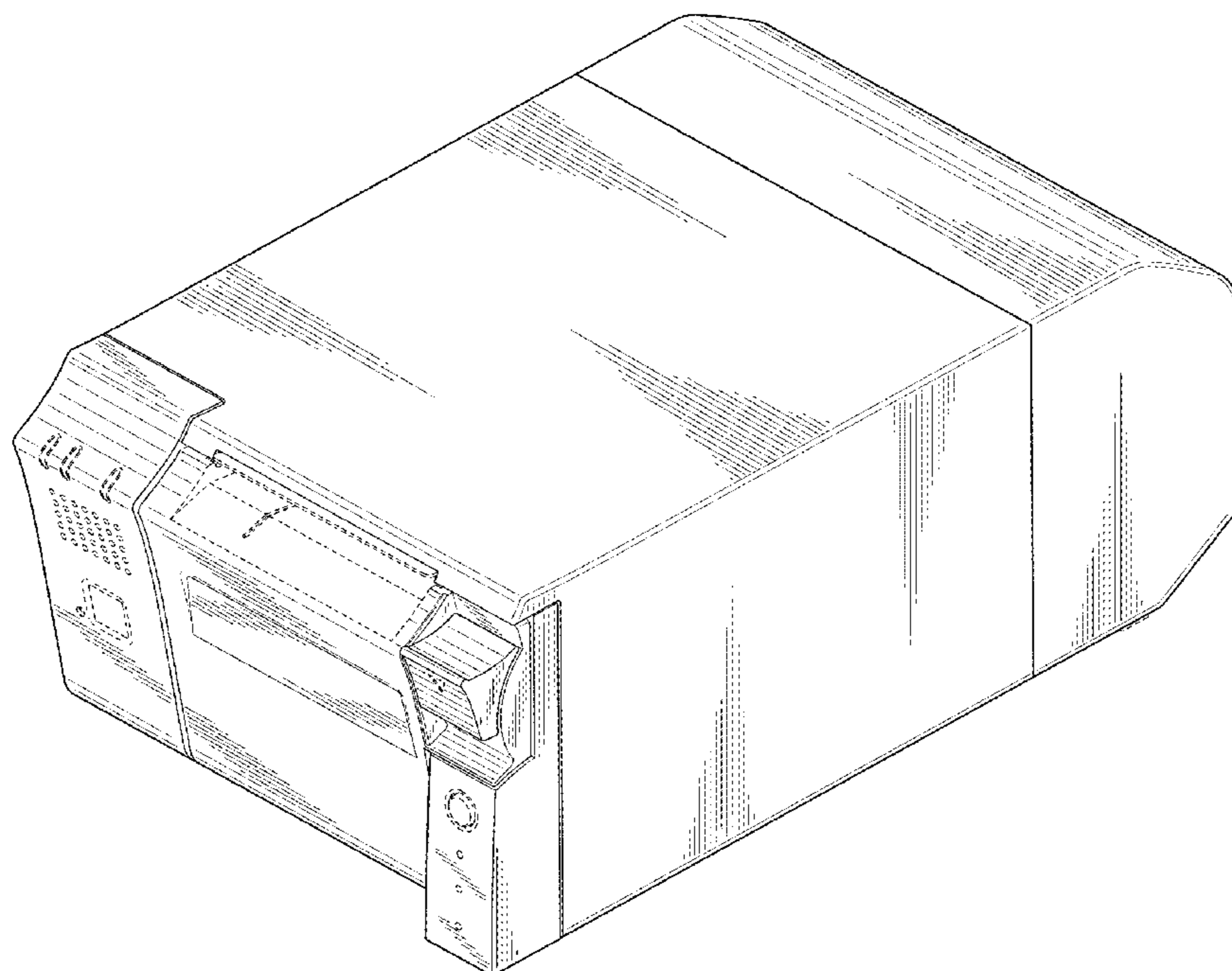

FIG. 1

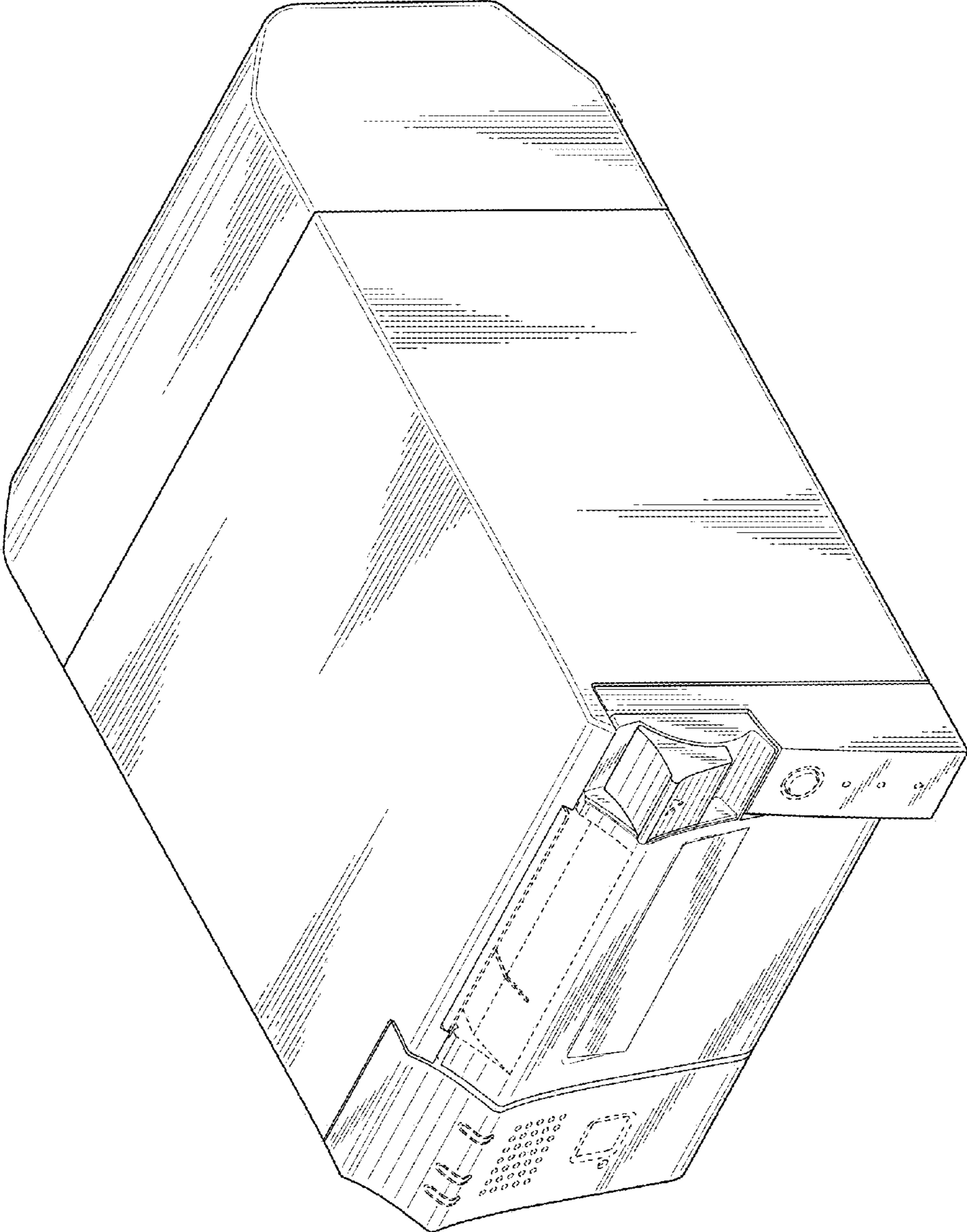

FIG. 2

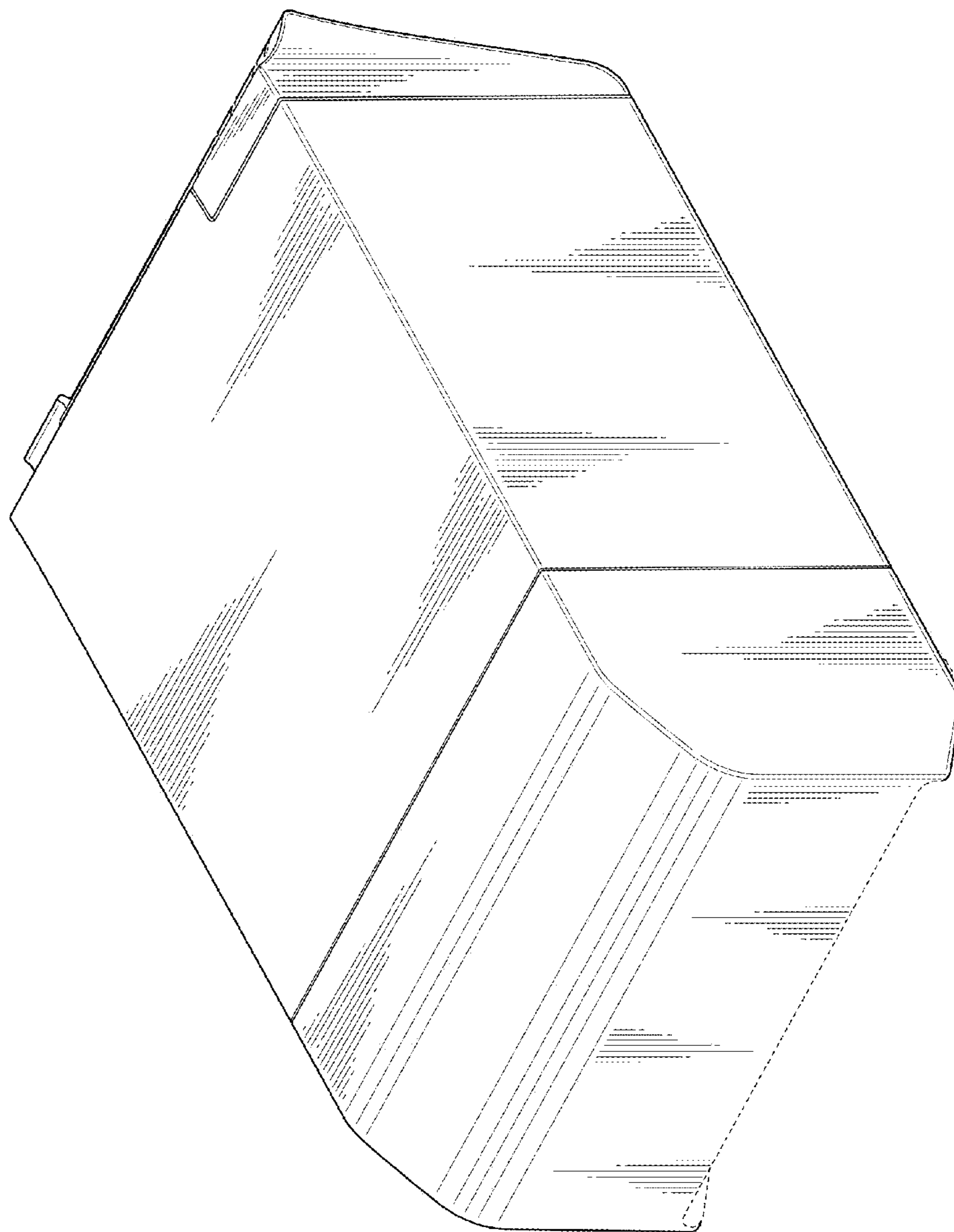

FIG. 3

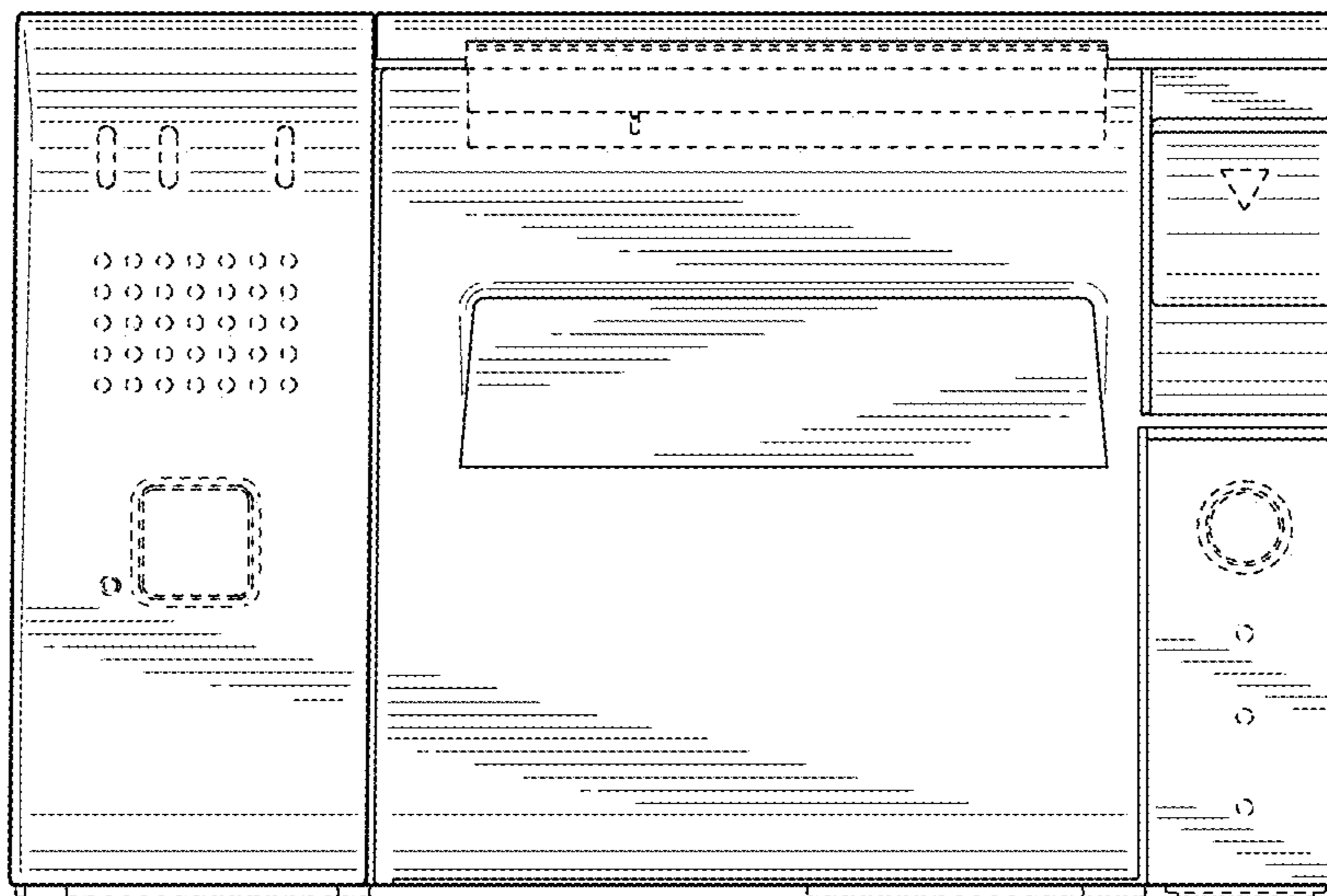

FIG. 4

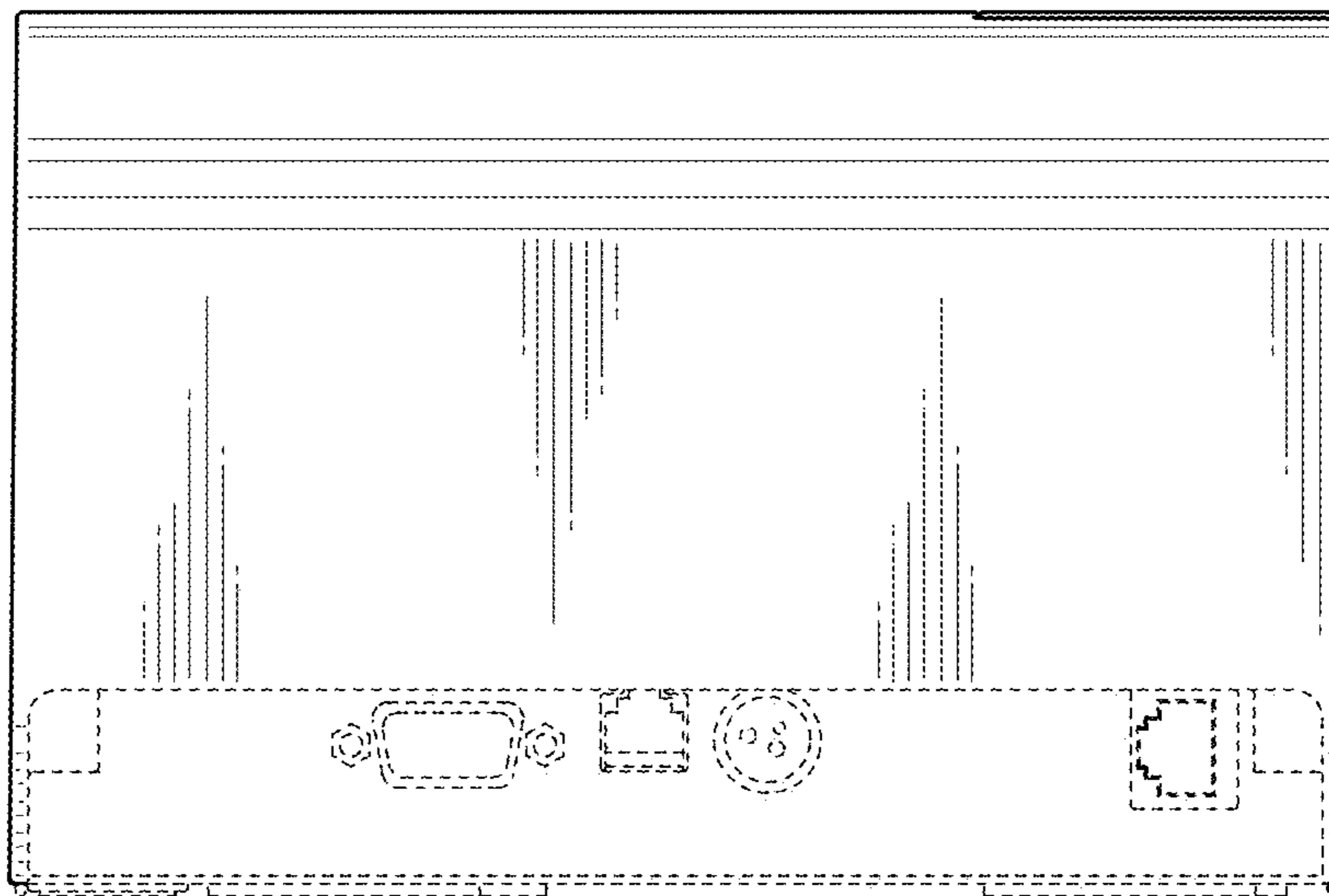

FIG. 5

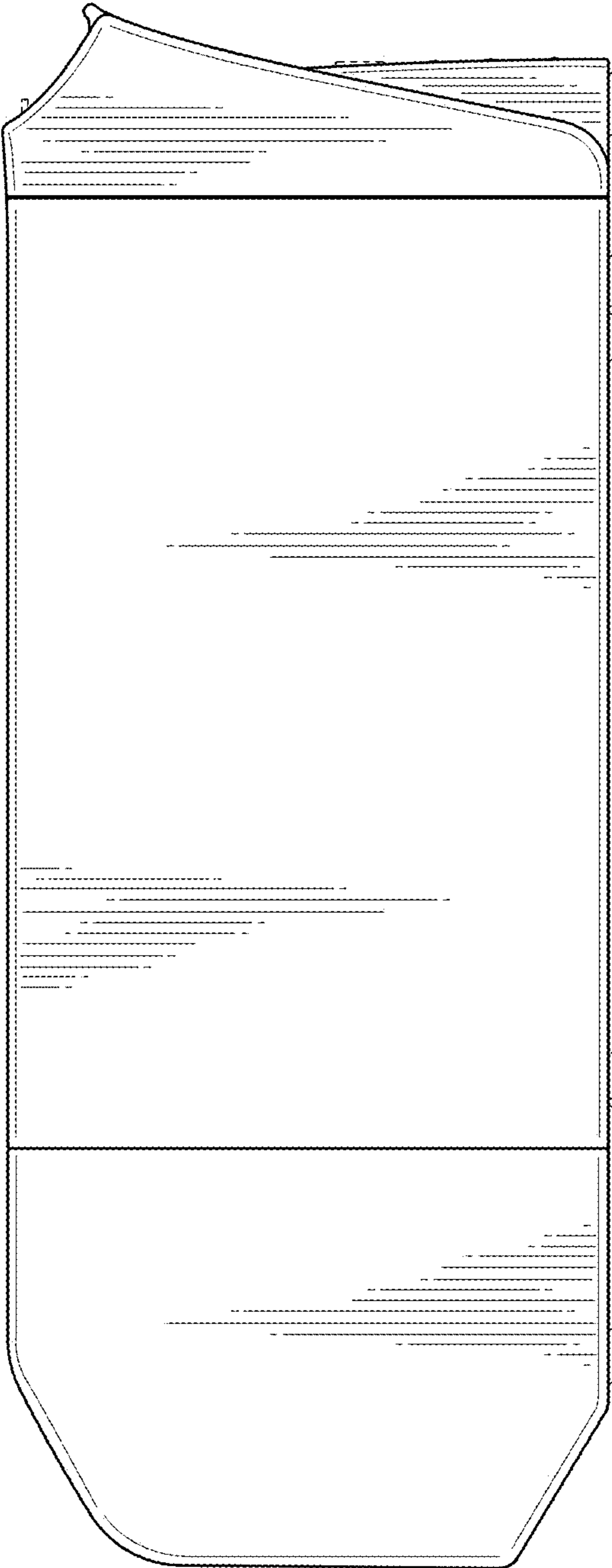

FIG. 6

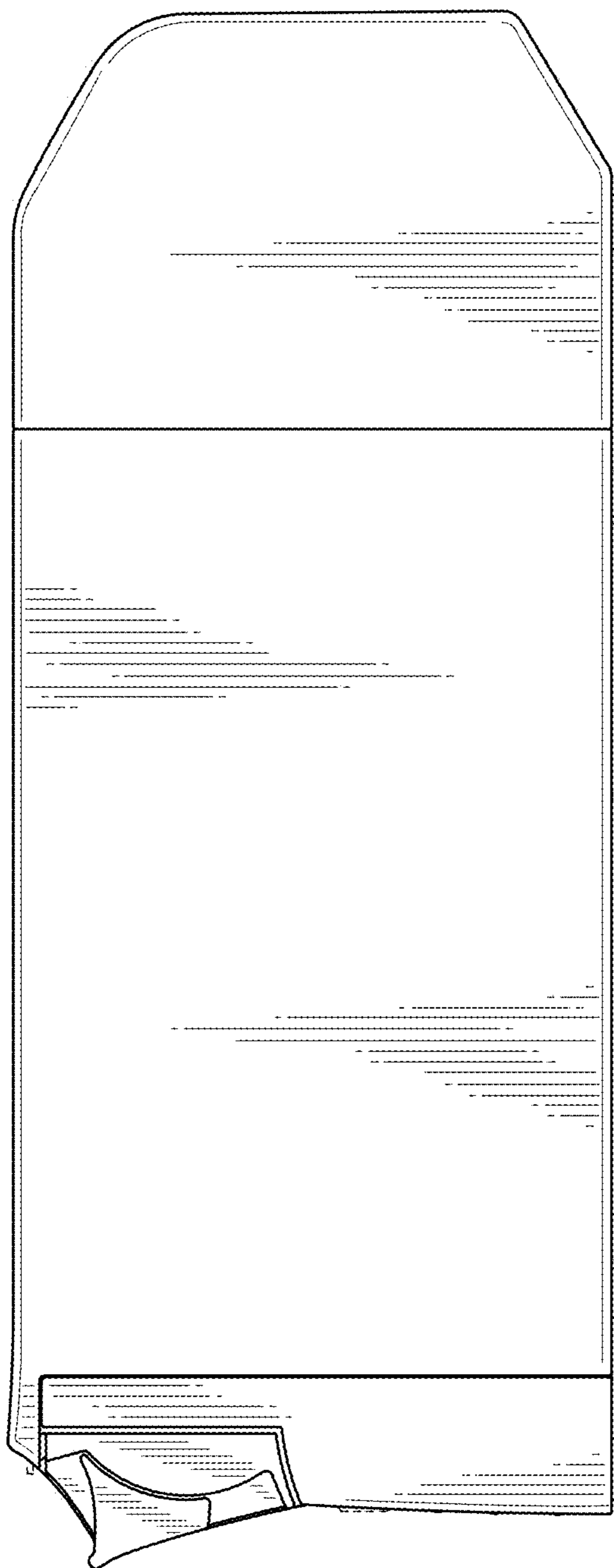

FIG. 7

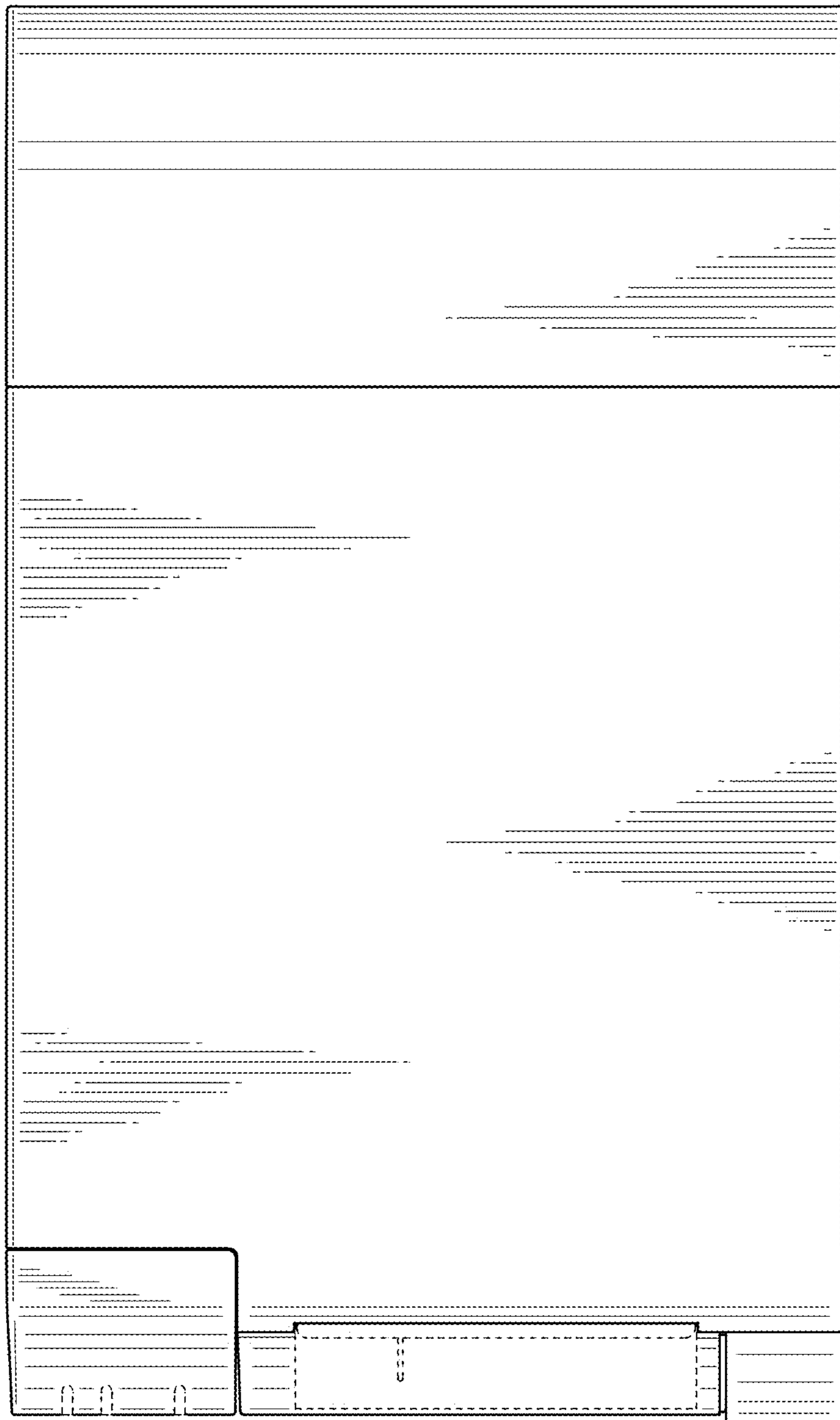

FIG. 8

