



US00D710432S

(12) **United States Design Patent**  
**Votel et al.**

(10) **Patent No.:** **US D710,432 S**  
(45) **Date of Patent:** **\*\* Aug. 5, 2014**

(54) **PROTECTIVE EYEWEAR**  
(71) Applicant: **Tenacious Holdings, Inc.**, St. Paul, MN (US)  
(72) Inventors: **Thomas Votel**, Sunfish Lake, MN (US);  
**Andrew Olson**, Minneapolis, MN (US);  
**Dominique Aris**, Louisville, CO (US);  
**Gregory Schrab**, Shoreview, MN (US)  
(73) Assignee: **Tenacious Holdings, Inc.**, St. Paul, MN (US)

(\*\*) Term: **14 Years**  
(21) Appl. No.: **29/489,413**  
(22) Filed: **Apr. 30, 2014**  
(51) **LOC (10) Cl.** ..... **16-06**  
(52) **U.S. Cl.**  
USPC ..... **D16/326; D16/335; D16/321**  
(58) **Field of Classification Search**  
CPC ..... **G02C 2200/08; G02C 1/06**  
USPC ..... **D16/101, 300-342, 900; D29/109-110;**  
**351/41, 44, 51-52, 62, 158, 92,**  
**351/103-123, 140-153, 63, 59, 45-46;**  
**2/426-432, 447-449, 441, 434-437,**  
**2/13, 15; D21/483, 659-661; D14/372**  
See application file for complete search history.

(56) **References Cited**  
U.S. PATENT DOCUMENTS  
D400,905 S \* 11/1998 Wang ..... D16/303  
D420,378 S \* 2/2000 Wu ..... D16/321

D524,846 S \* 7/2006 Teng ..... D16/326  
D549,270 S \* 8/2007 Daems et al. .... D16/321  
7,255,435 B2 \* 8/2007 Pratt ..... 351/44  
D552,665 S \* 10/2007 Mage ..... D16/326  
D586,841 S \* 2/2009 Yang ..... D16/326  
D587,741 S \* 3/2009 Chen ..... D16/326  
D638,876 S \* 5/2011 Sheldon ..... D16/326  
D663,764 S \* 7/2012 Serlenga ..... D16/326  
D670,325 S \* 11/2012 Chen ..... D16/326  
8,303,109 B2 \* 11/2012 Matera ..... 351/62  
D700,648 S \* 3/2014 Siracusa ..... D16/311

\* cited by examiner  
*Primary Examiner* — Raphael Barkai  
(74) *Attorney, Agent, or Firm* — Skaar Ulbrich Macari, P.A.

(57) **CLAIM**  
We claim the ornamental design for protective eyewear, as shown and described.

**DESCRIPTION**  
FIG. 1 is a perspective of our protective eyewear.  
FIG. 2 is a front elevation view thereof.  
FIG. 3 is a rear elevation view thereof.  
FIG. 4 is a top plan view thereof.  
FIG. 5 is a bottom plan view thereof; and,  
FIG. 6 is a side elevation view thereof.  
The broken lines in the drawings illustrate features of the article to which the design is applied that forms no part of the claim.

**1 Claim, 5 Drawing Sheets**

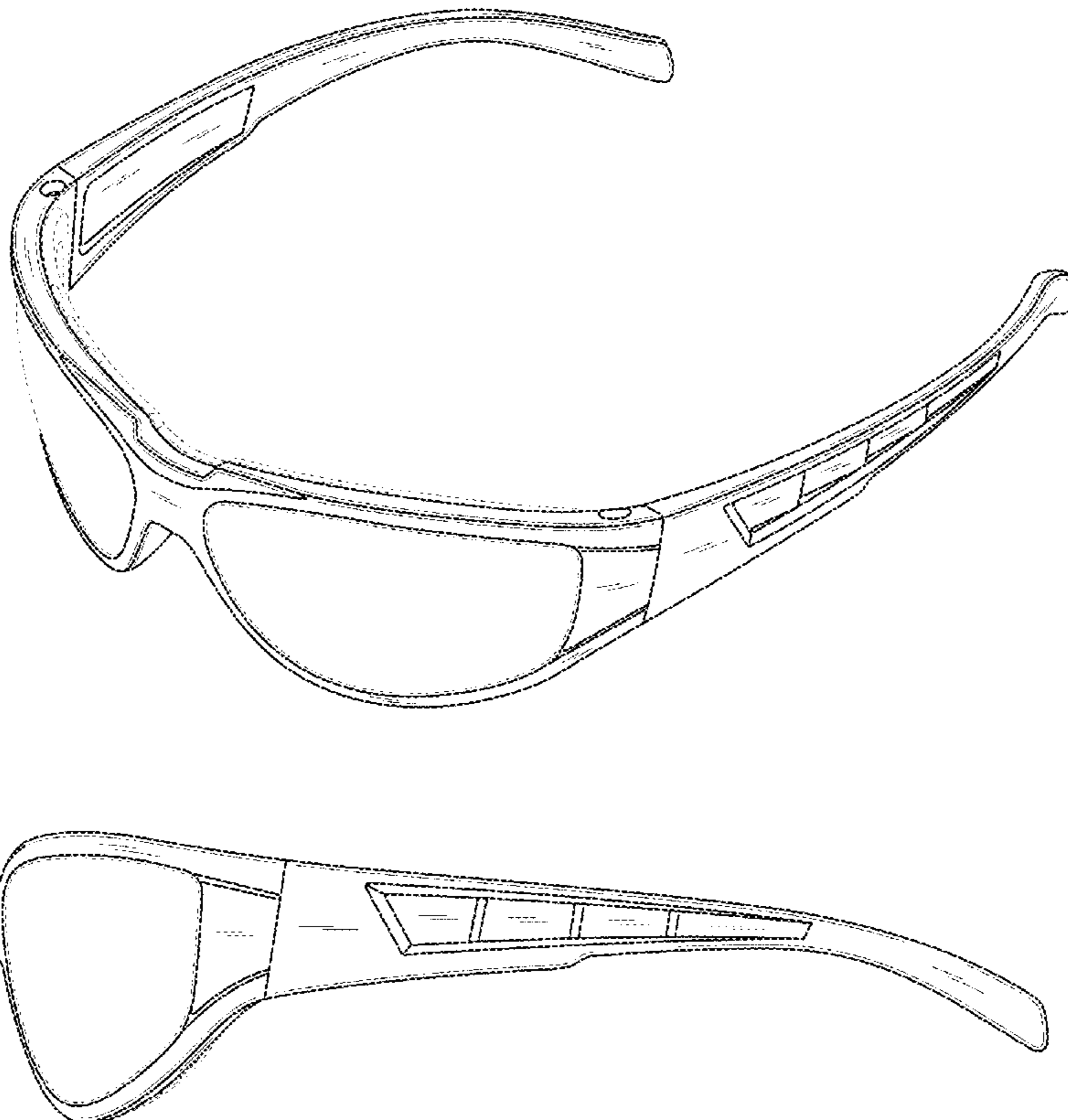

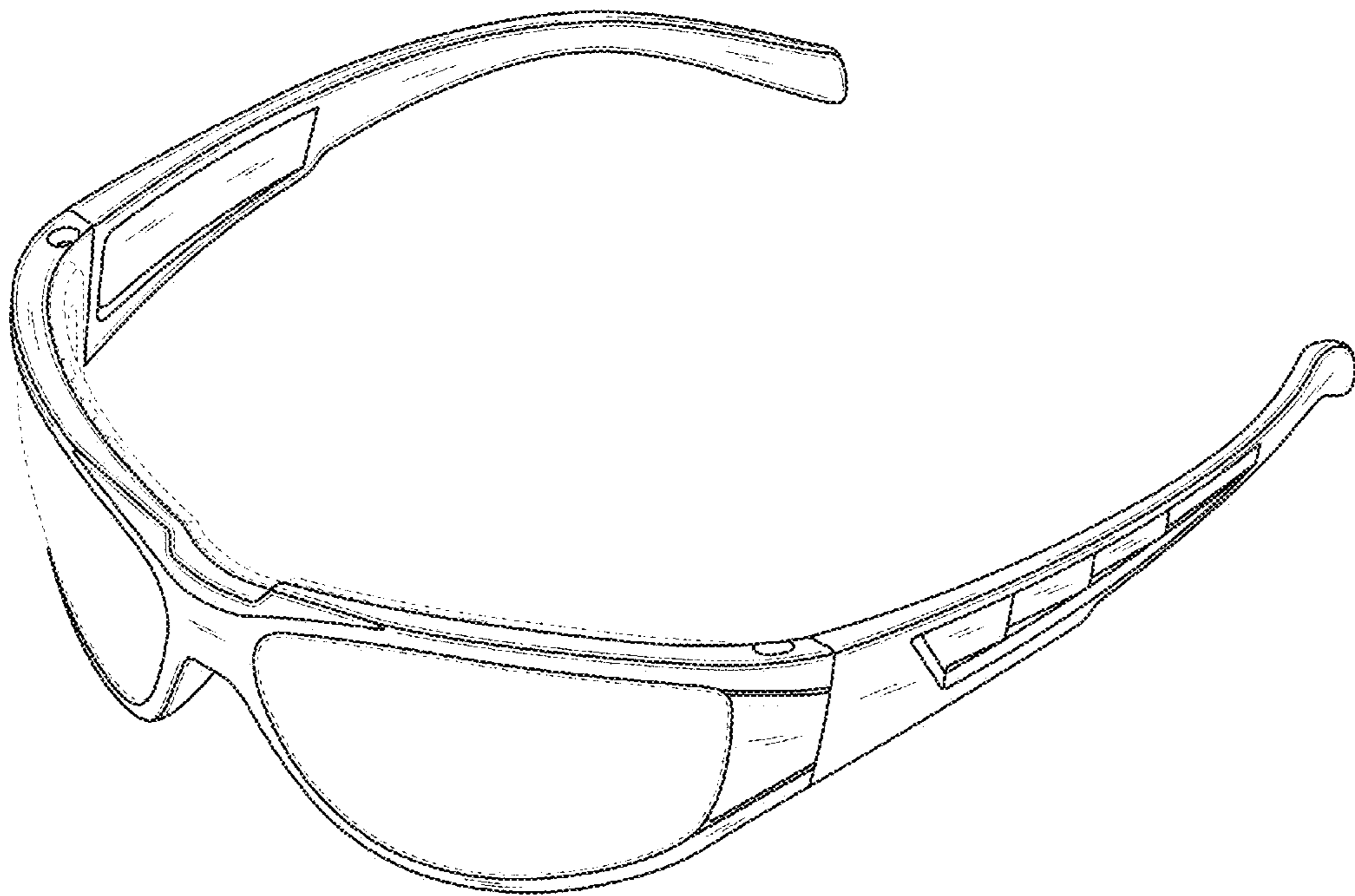

Fig. 1

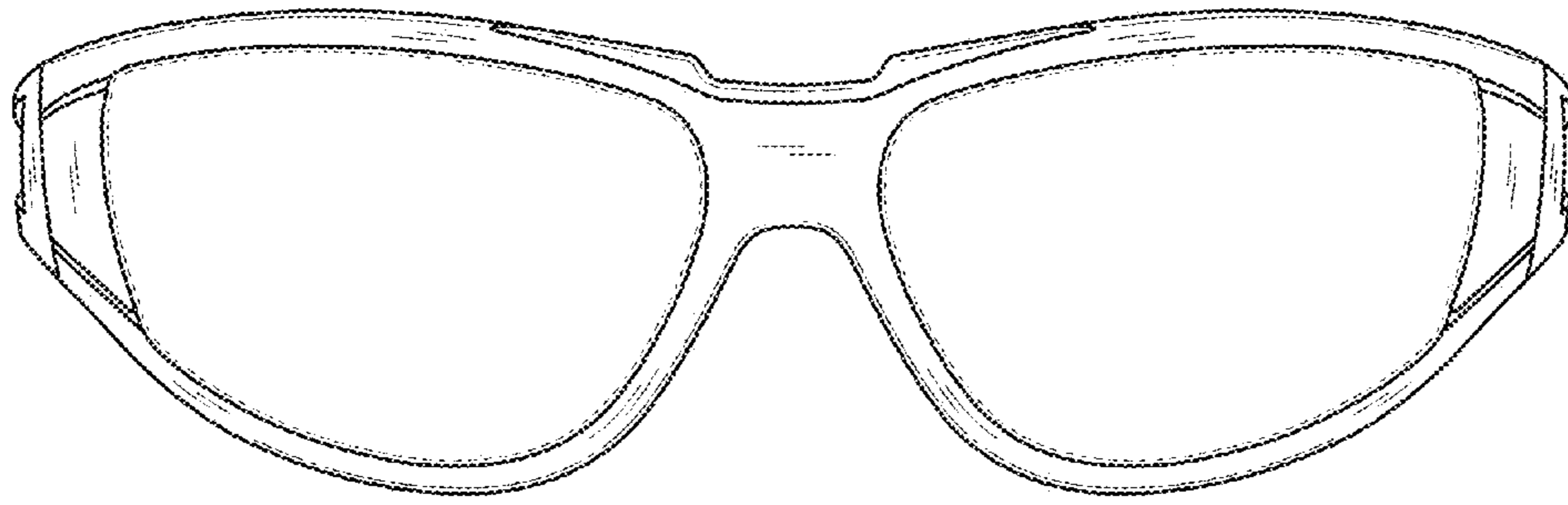

Fig. 2

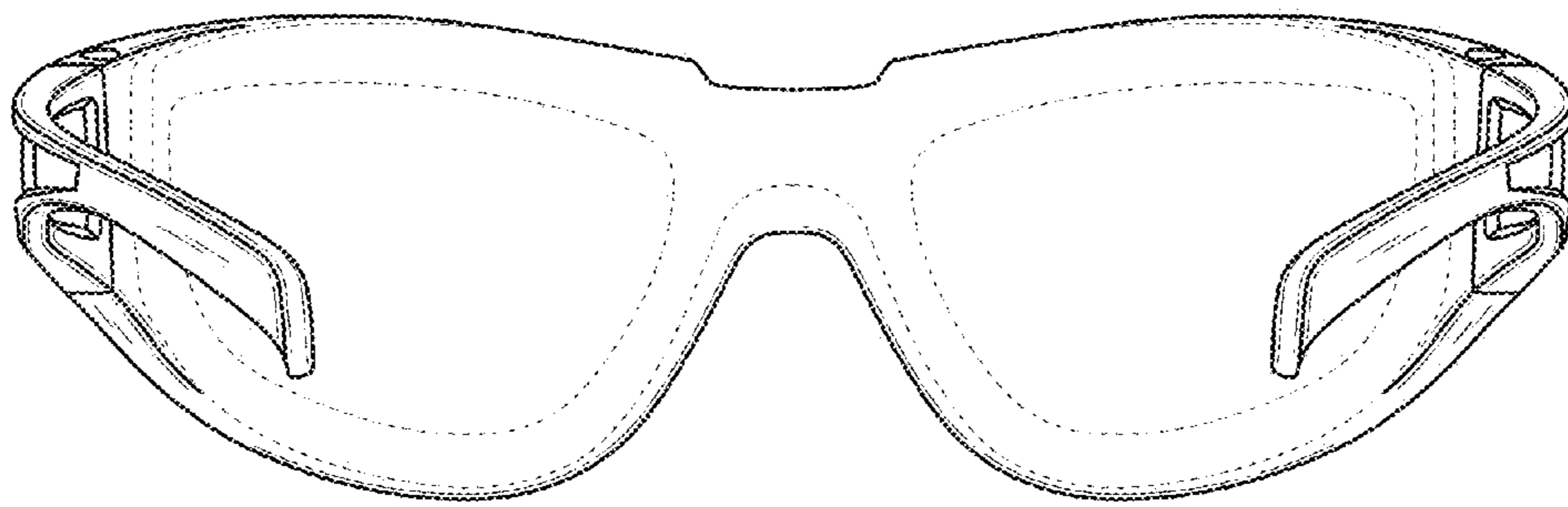

Fig. 3

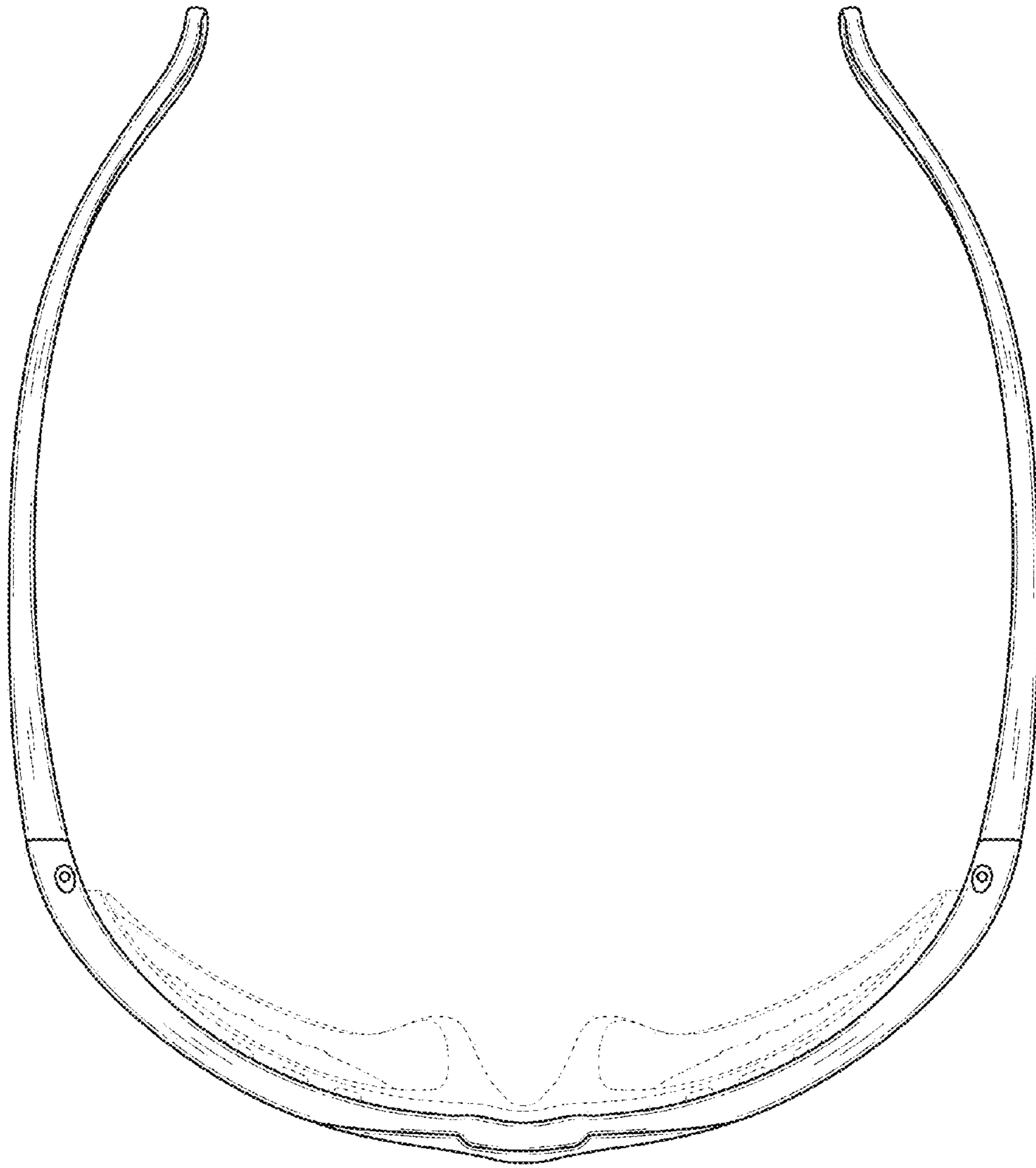

Fig. 4

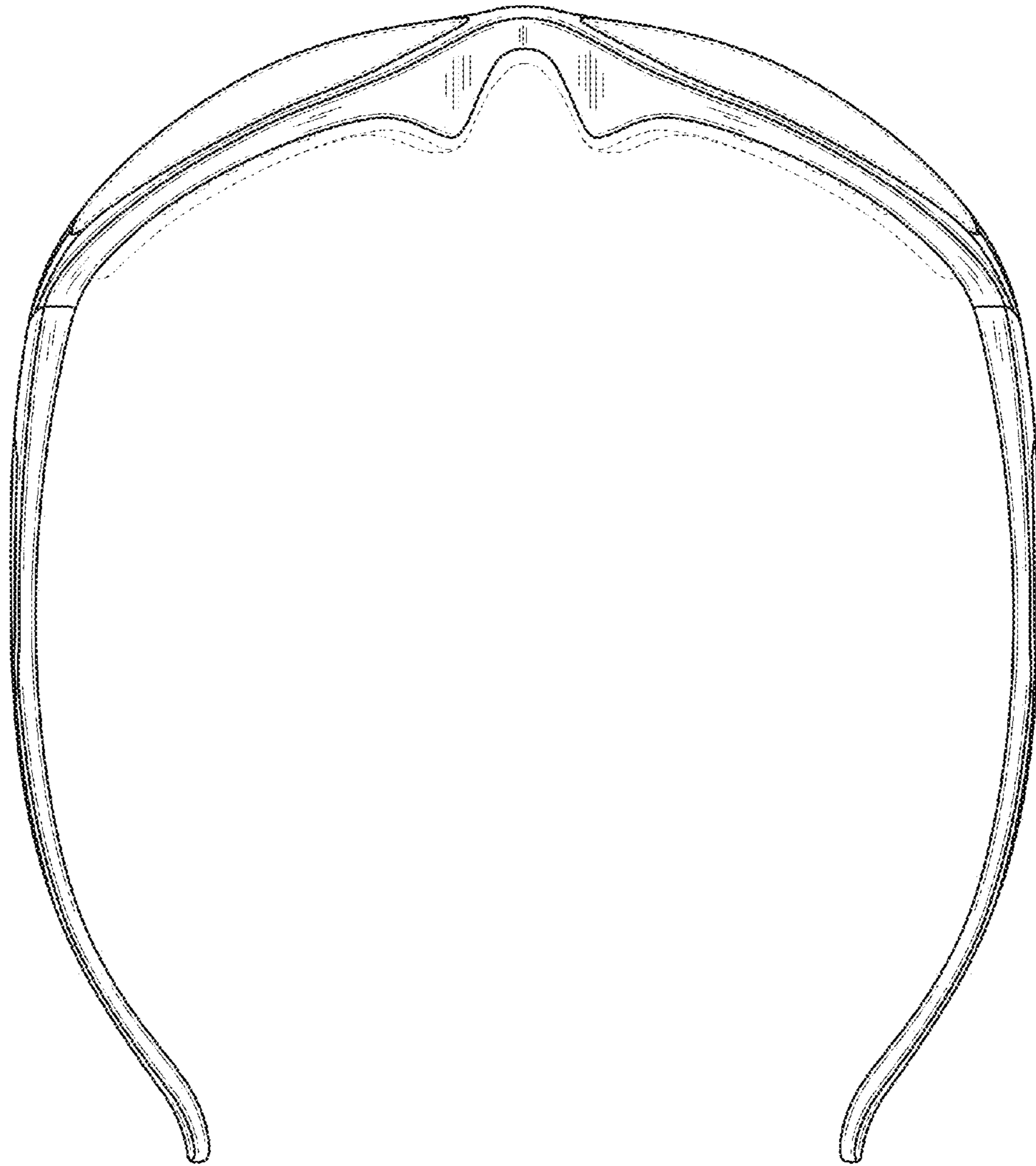

Fig. 5

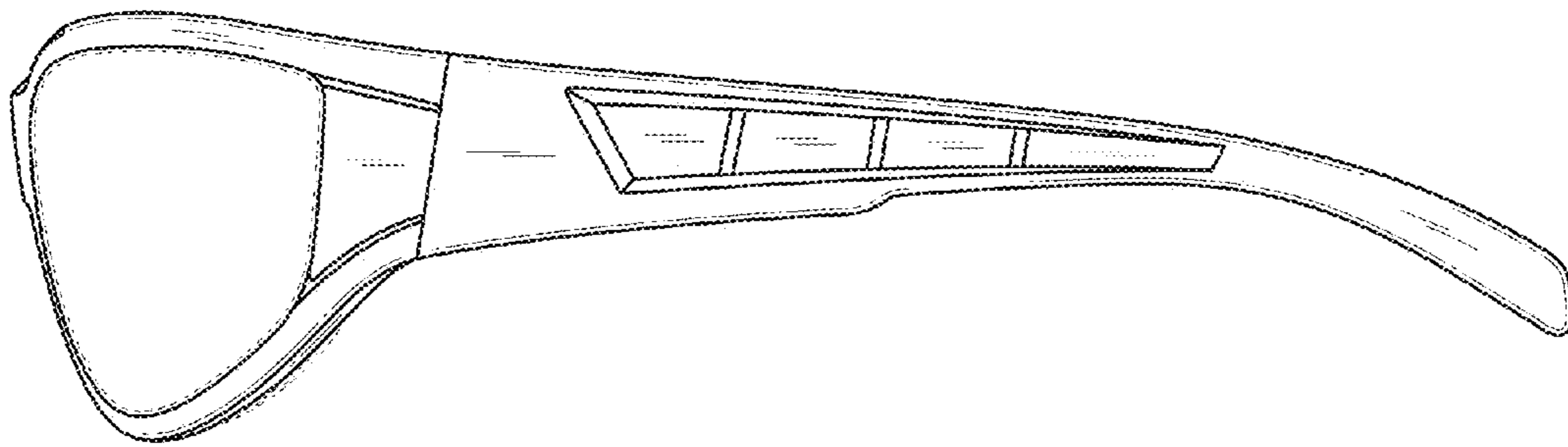

Fig. 6