



US00D710387S

(12) **United States Design Patent**
Aglassinger

(10) **Patent No.:** **US D710,387 S**

(45) **Date of Patent:** **** Aug. 5, 2014**

(54) **SOUND REPRODUCTION EQUIPMENT**

(56) **References Cited**

(71) Applicant: **Robert Bosch GmbH**, Stuttgart (DE)

U.S. PATENT DOCUMENTS

(72) Inventor: **Hans-Peter Aglassinger**, Esslingen (DE)

3,525,552	A *	8/1970	Oberthur	303/9.75
3,985,201	A *	10/1976	Kloster	181/163
4,190,739	A *	2/1980	Torffield	381/305
6,204,830	B1 *	3/2001	Raussi	345/10
D597,557	S *	8/2009	Hu	D14/496
D651,618	S *	1/2012	Barley	D14/496
D660,287	S *	5/2012	McManigal	D14/217
D680,086	S *	4/2013	Kaku	D14/125
D681,612	S *	5/2013	Palacios	D14/238.1
D692,460	S *	10/2013	Zunker	D14/496
8,553,890	B2 *	10/2013	Yokota	381/1
D696,297	S *	12/2013	Fang	D14/496
8,616,327	B1 *	12/2013	Palacios	181/175

(73) Assignee: **Robert Bosch GmbH**, Stuttgart (DE)

(**) Term: **14 Years**

(21) Appl. No.: **29/453,103**

(22) Filed: **Apr. 25, 2013**

* cited by examiner

(30) **Foreign Application Priority Data**

Oct. 25, 2012 (EM) 002124578

Primary Examiner — Prabhakar Deshmukh

(74) *Attorney, Agent, or Firm* — Maginot, Moore & Beck

(51) **LOC (10) Cl.** **14-03**

(57) **CLAIM**

The ornamental design for sound reproduction equipment, as shown and described.

(52) **U.S. Cl.**

USPC **D14/496**

DESCRIPTION

(58) **Field of Classification Search**

USPC D14/204, 204.1, 210-216, 172, 209.1,
D14/496, 474, 160.167, 168, 188,
D14/203.1-203.8, 238.1, 260, 265;
181/143, 144, 147, 148, 150-153, 157,
181/198, 199, 175, 210, 211, 123-125;
381/300-306, 332, 333, 336, 345,
381/361-364, 1, 2, 61, 71.1, 73.1, 94.1

FIG. 1 is a perspective view of sound reproduction equipment showing my new design;
FIG. 2 is a front elevation view thereof;
FIG. 3 is a rear elevation view thereof;
FIG. 4 is a right side elevation view thereof;
FIG. 5 is a left side elevation view thereof;
FIG. 6 is a top plan view thereof; and,
FIG. 7 is a bottom plan view thereof.
The broken lines indicate unclaimed portions and form no part of the claimed design.

See application file for complete search history.

1 Claim, 7 Drawing Sheets

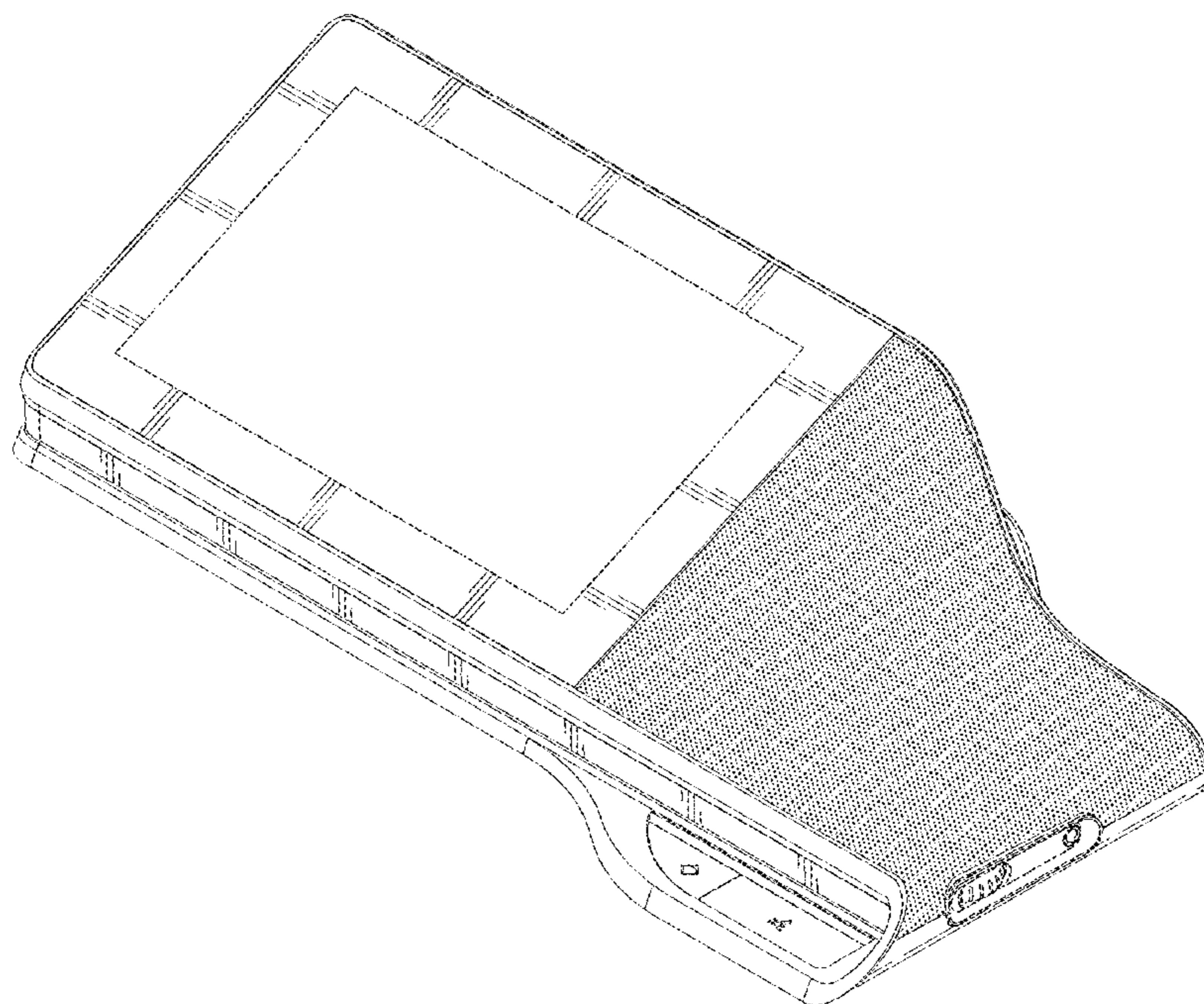

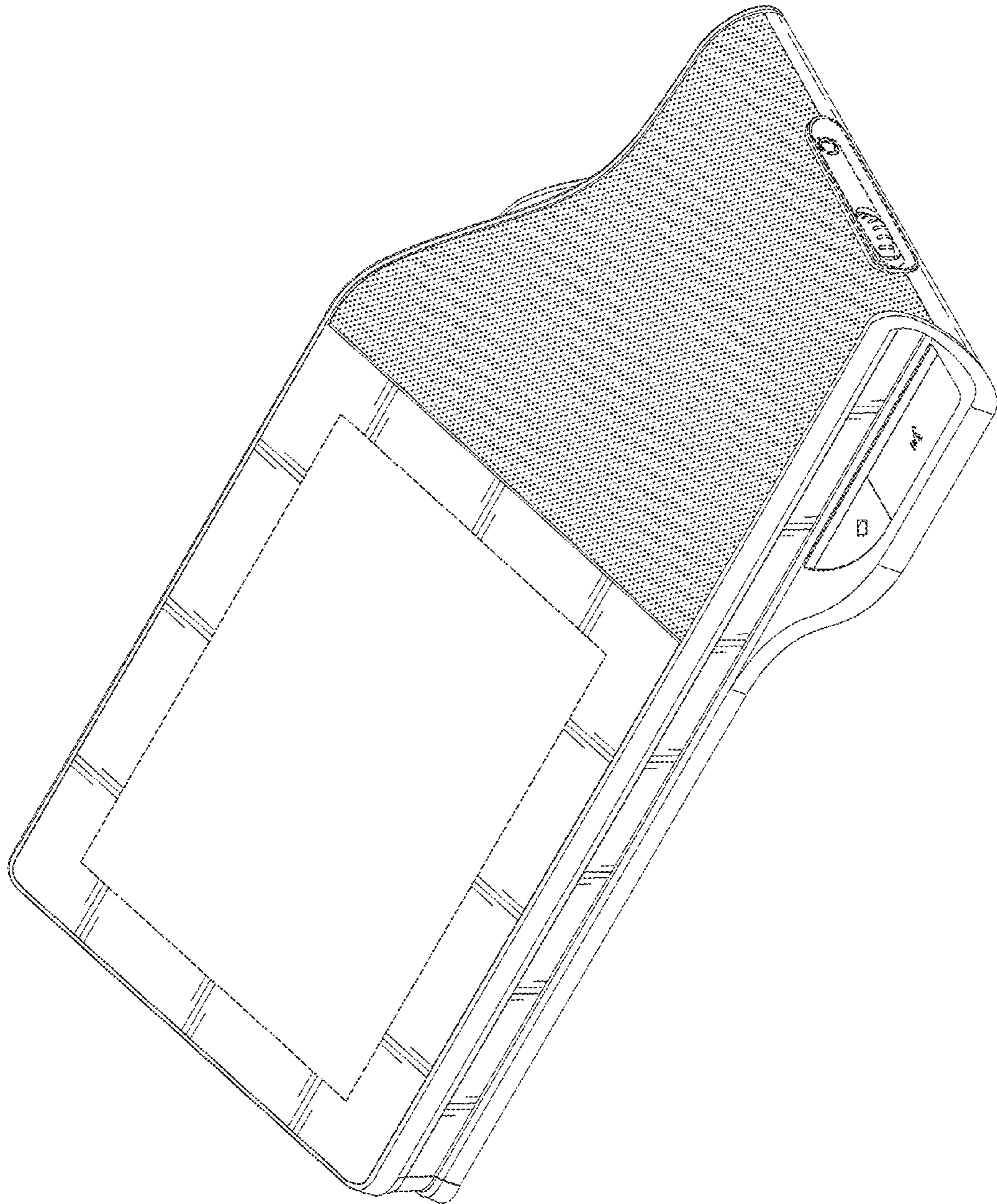

Fig. 1

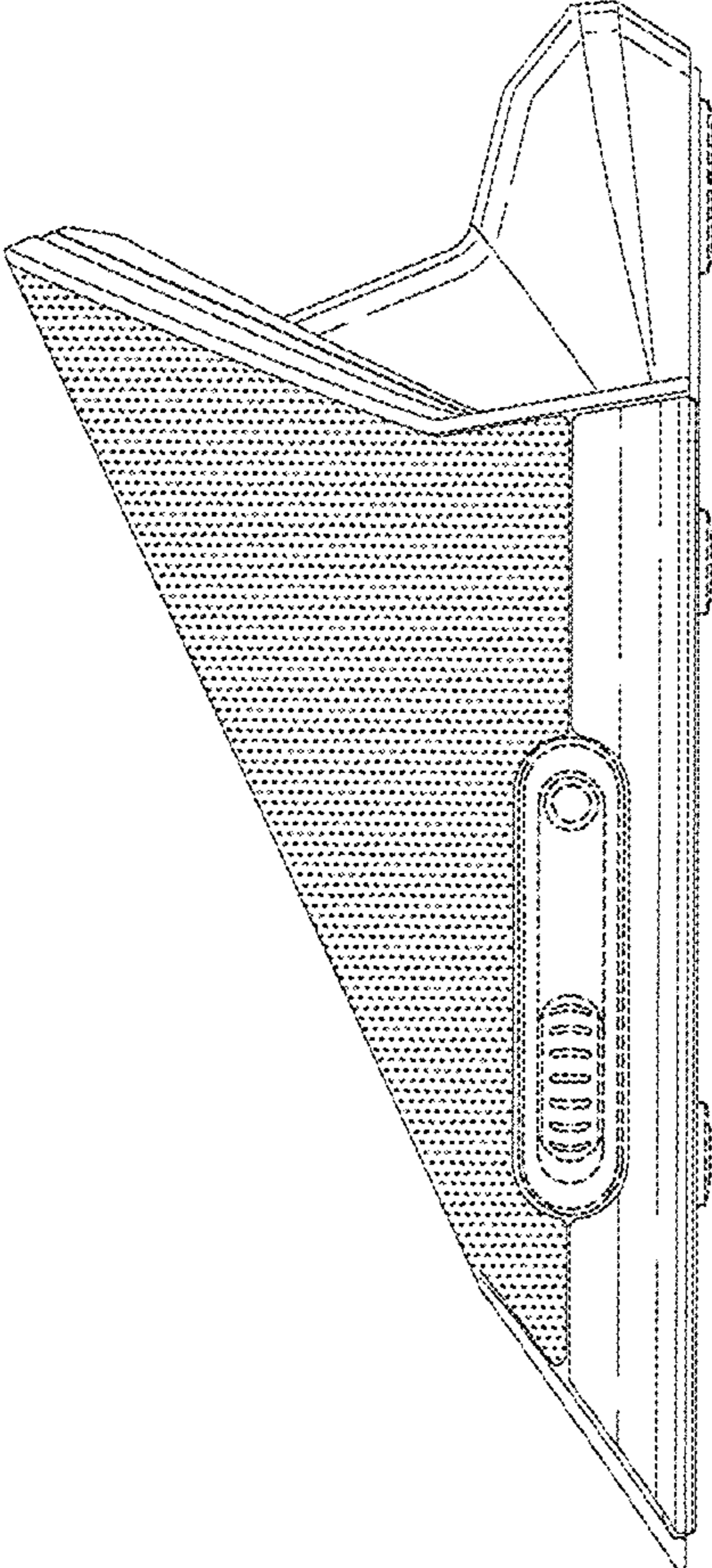

Fig. 2

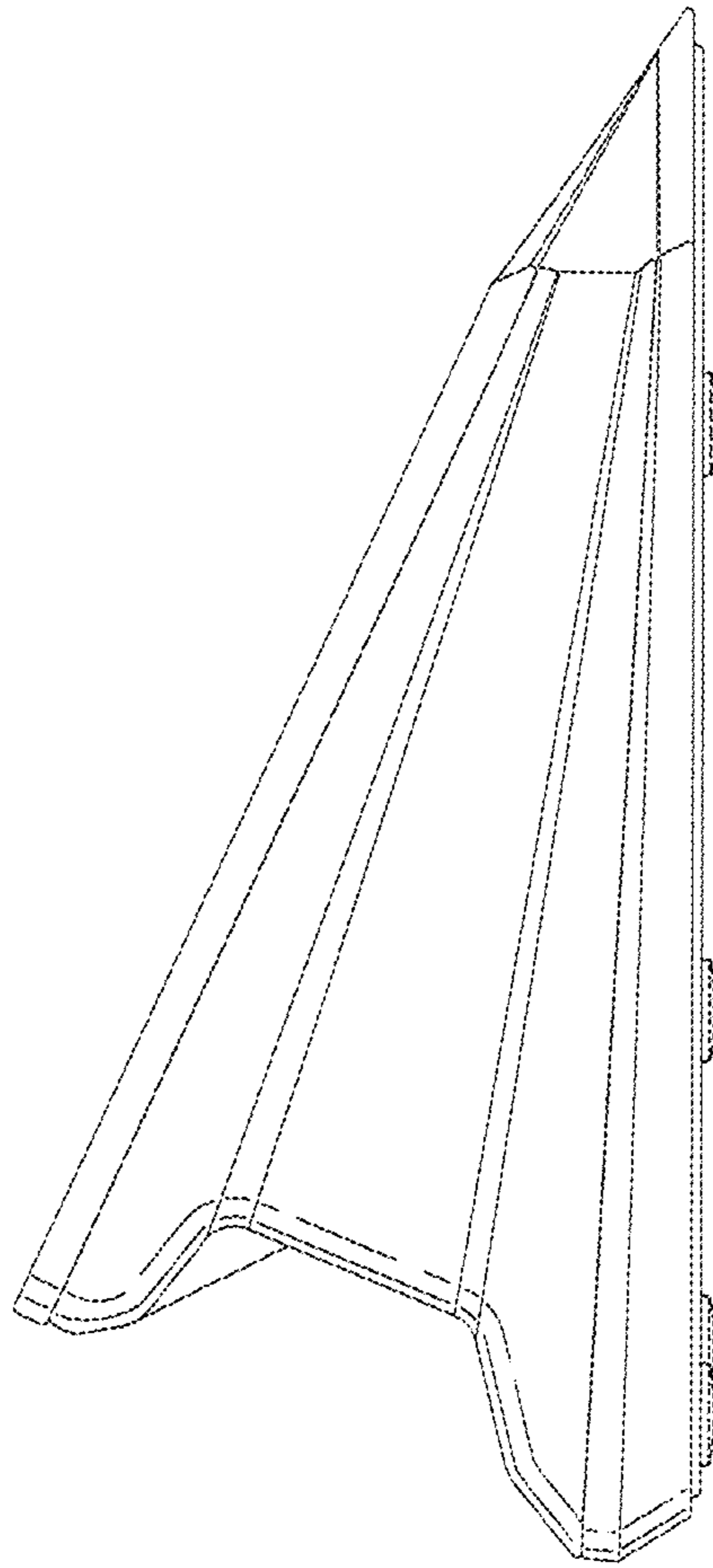

Fig. 3

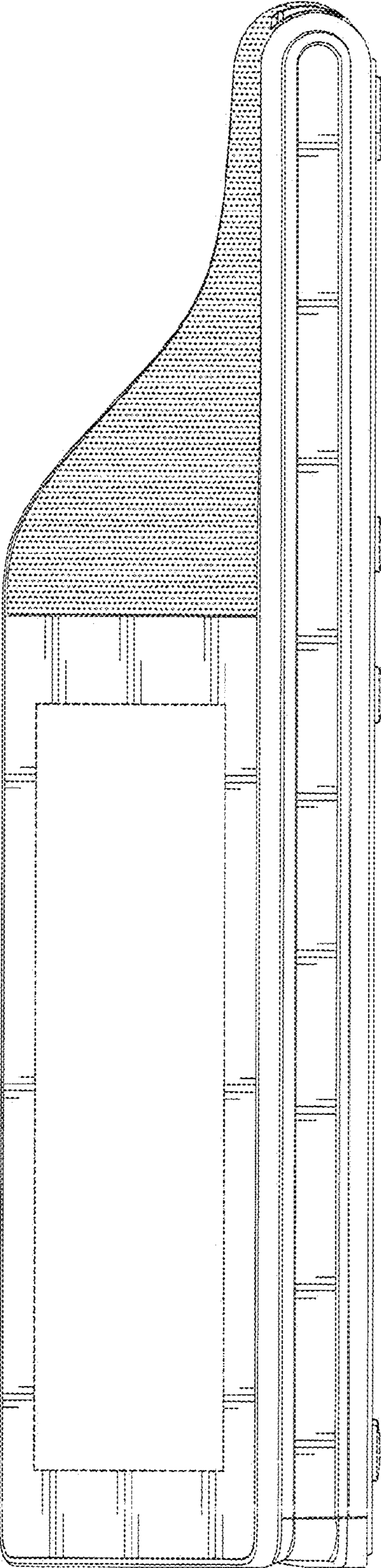

Fig. 4

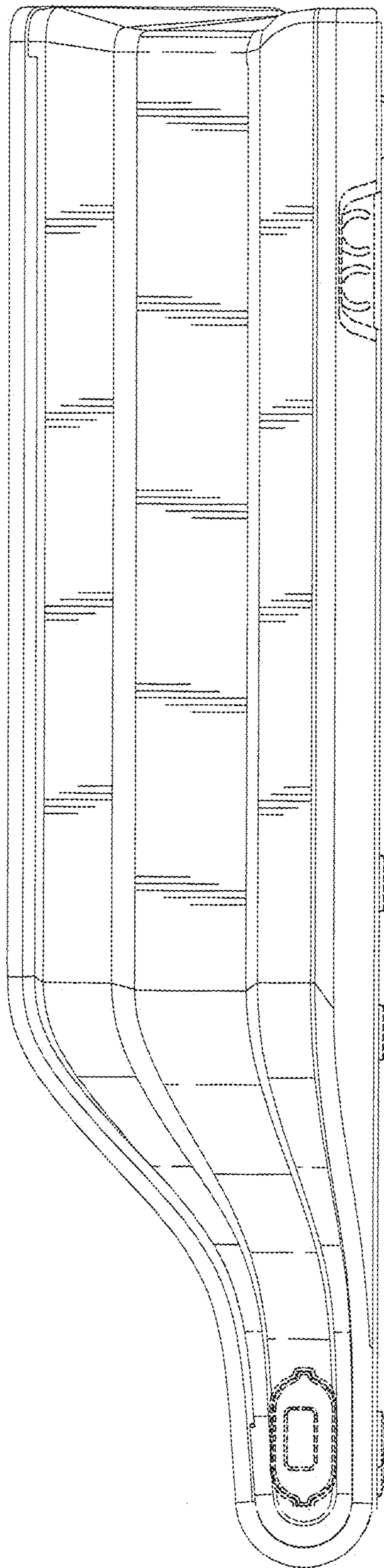

Fig. 5

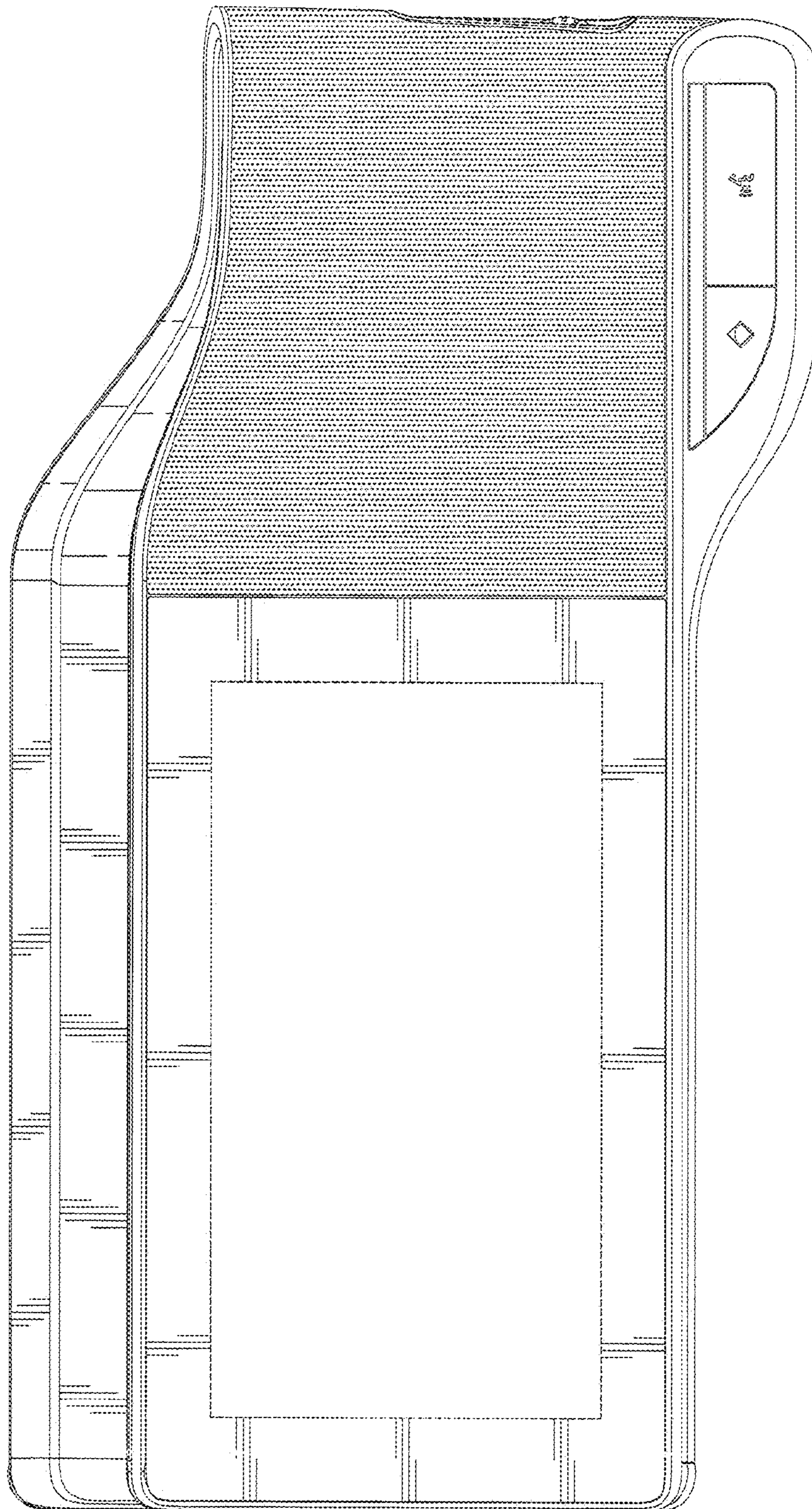

Fig. 6

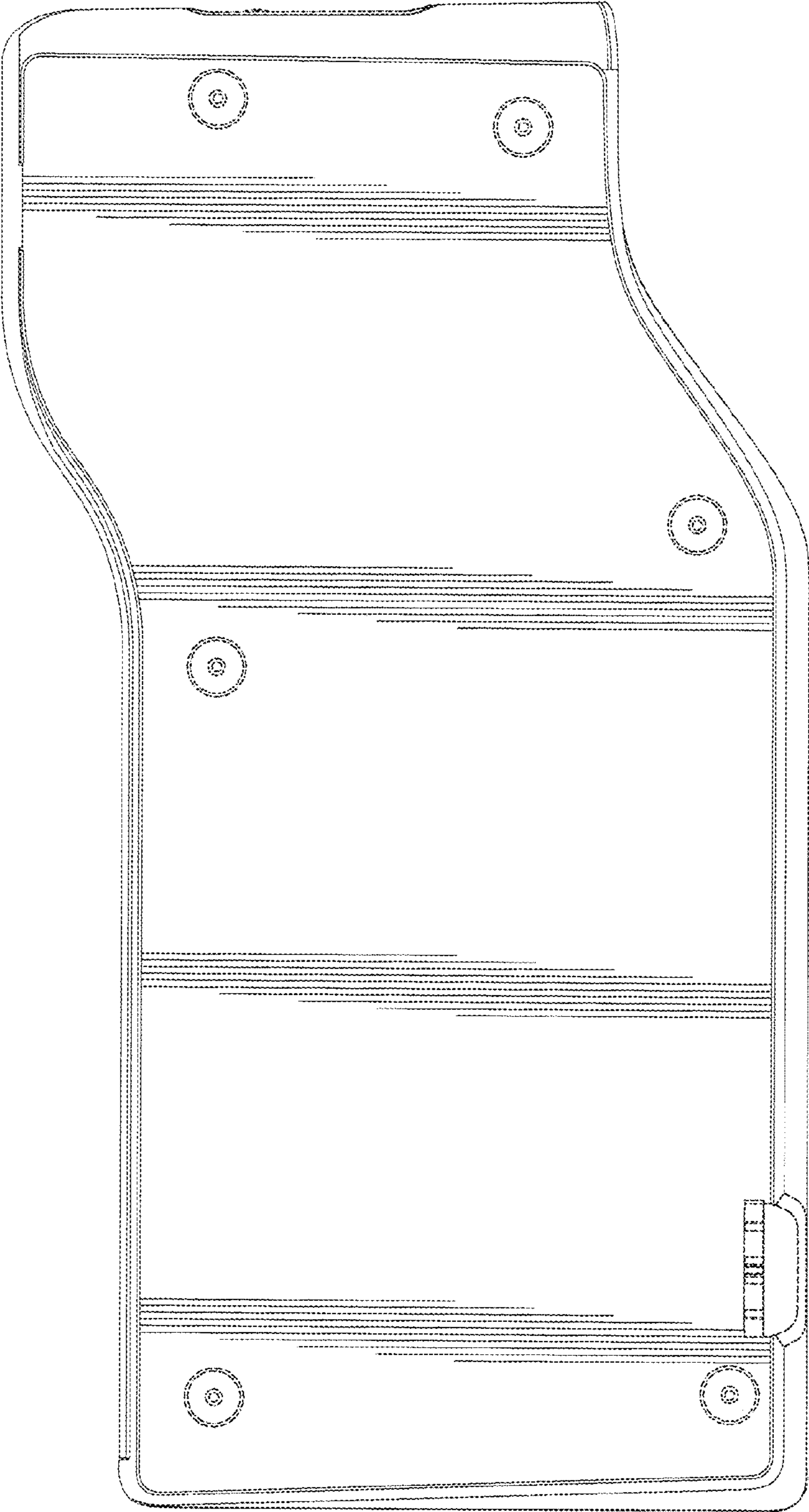

Fig. 7