



US00D710330S

(12) **United States Design Patent**
Miller

(10) **Patent No.:** **US D710,330 S**

(45) **Date of Patent:** **** Aug. 5, 2014**

(54) **COVER FOR REMOTE CONTROLLER FOR SET TOP SATELLITE T.V. BOX**

(71) Applicant: **Richard E. Miller**, Homer City, PA (US)

(72) Inventor: **Richard E. Miller**, Homer City, PA (US)

(**) Term: **14 Years**

(21) Appl. No.: **29/472,932**

(22) Filed: **Nov. 18, 2013**

(51) **LOC (10) Cl.** **14-03**

(52) **U.S. Cl.**
USPC **D14/218**

(58) **Field of Classification Search**
USPC D14/218, 455, 400, 454; D13/168;
D21/566; D10/104, 106; 345/169;
348/14.05, 114, 211.99, 734;
340/825.24; 341/22; 455/92, 95, 128,
455/151.1-151.4, 352, 355, FOR. 121;
700/65

See application file for complete search history.

(56) **References Cited**

U.S. PATENT DOCUMENTS

D459,346 S *	6/2002	Powell	D14/250
D460,445 S *	7/2002	Nguyen et al.	D14/250
D485,834 S *	1/2004	Davetas	D14/250
D504,677 S *	5/2005	Kaminski et al.	D14/218
D524,298 S *	7/2006	Hedderich et al.	D14/218
D527,375 S *	8/2006	Flora et al.	D14/218
D540,539 S *	4/2007	Gutierrez	D3/269
D565,554 S *	4/2008	Fan	D14/218

D605,634 S *	12/2009	Lewis et al.	D14/218
D620,925 S *	8/2010	Geck et al.	D14/218
D624,903 S *	10/2010	Wlotzka	D14/218
D631,098 S *	1/2011	Ashida et al.	D21/333
D631,871 S *	2/2011	Demskie et al.	D14/218
D636,761 S *	4/2011	Hansen et al.	D14/218
D656,127 S *	3/2012	Kay et al.	D14/218

* cited by examiner

Primary Examiner — John Windmuller

(74) *Attorney, Agent, or Firm* — The Webb Law Firm

(57) **CLAIM**

The ornamental design for a cover for remote controller for set top satellite T.V. box, as shown and described.

DESCRIPTION

FIG. 1 is a top view of a cover for remote controller for set top satellite T.V. box showing my new design;
 FIG. 2 is a bottom view thereof;
 FIG. 3 is a front view thereof;
 FIG. 4 is a rear view thereof;
 FIG. 5 is a left side view thereof;
 FIG. 6 is a right side view thereof;
 FIG. 7 is an upper right rear perspective view thereof;
 FIG. 8 is a lower left front perspective view thereof;
 FIG. 9 is a cross-sectional view thereof taken along lines 9-9 shown in FIG. 1; and,
 FIG. 10 is a cross-sectional view thereof taken along lines 10-10 shown in FIG. 1.
 The broken lines in the figures depict portions of the remote controller that form no part of the claimed design.

1 Claim, 7 Drawing Sheets

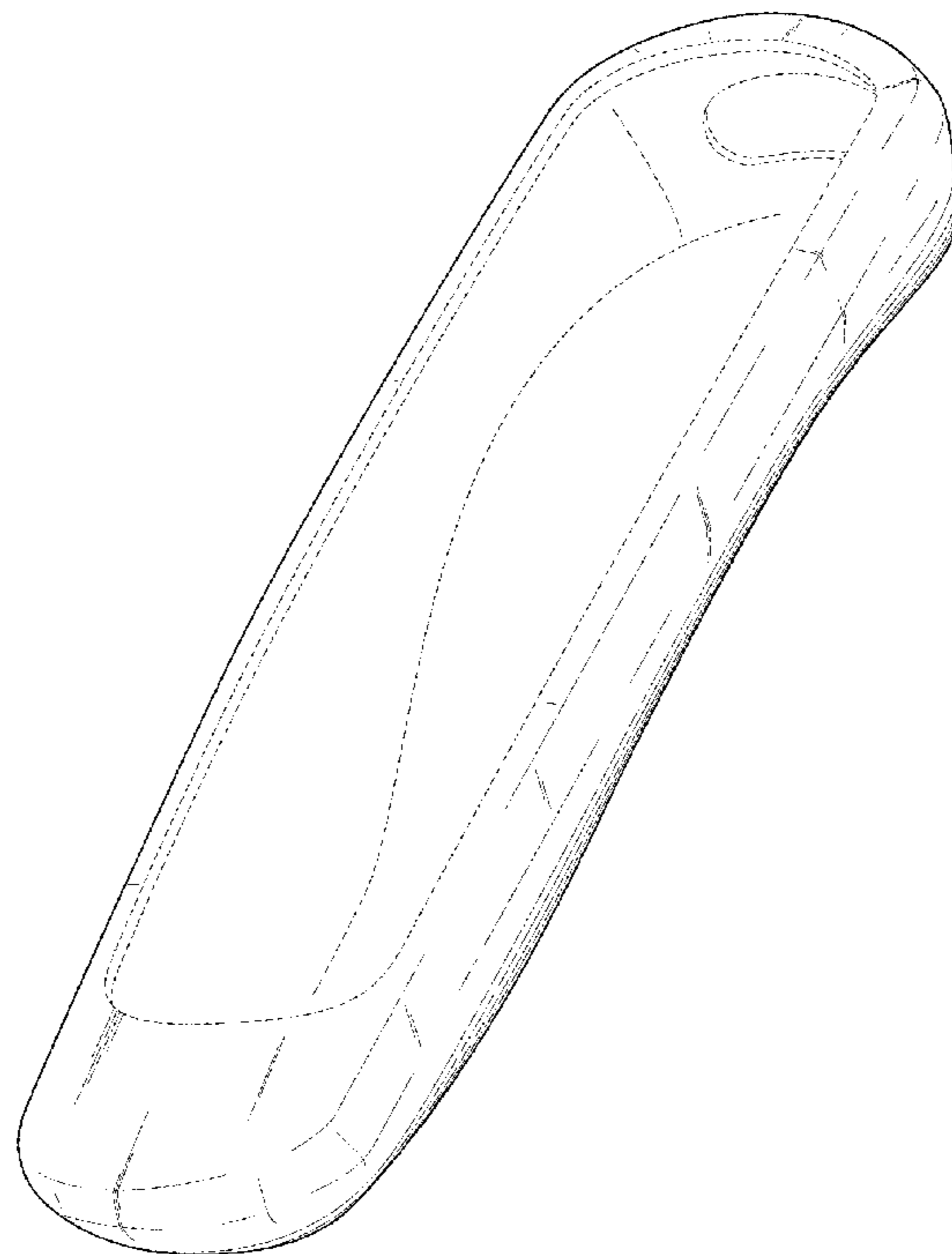

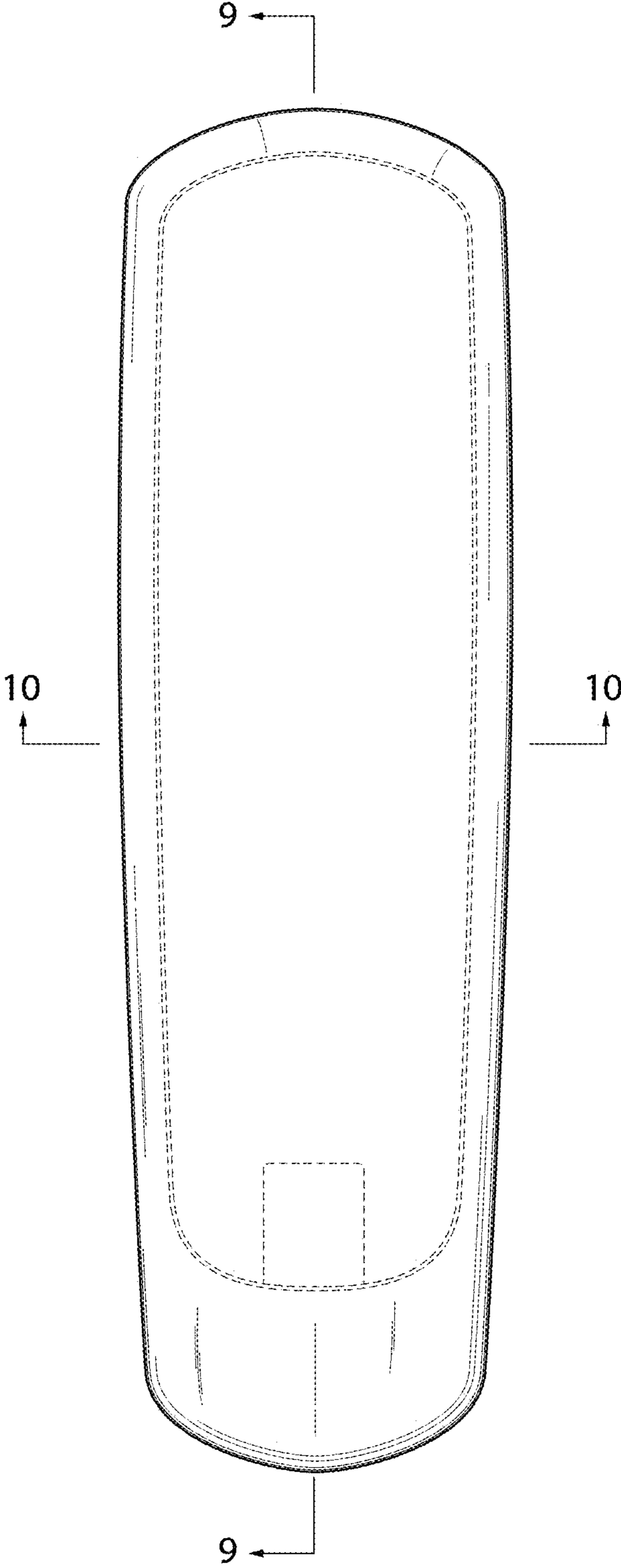

FIG. 1

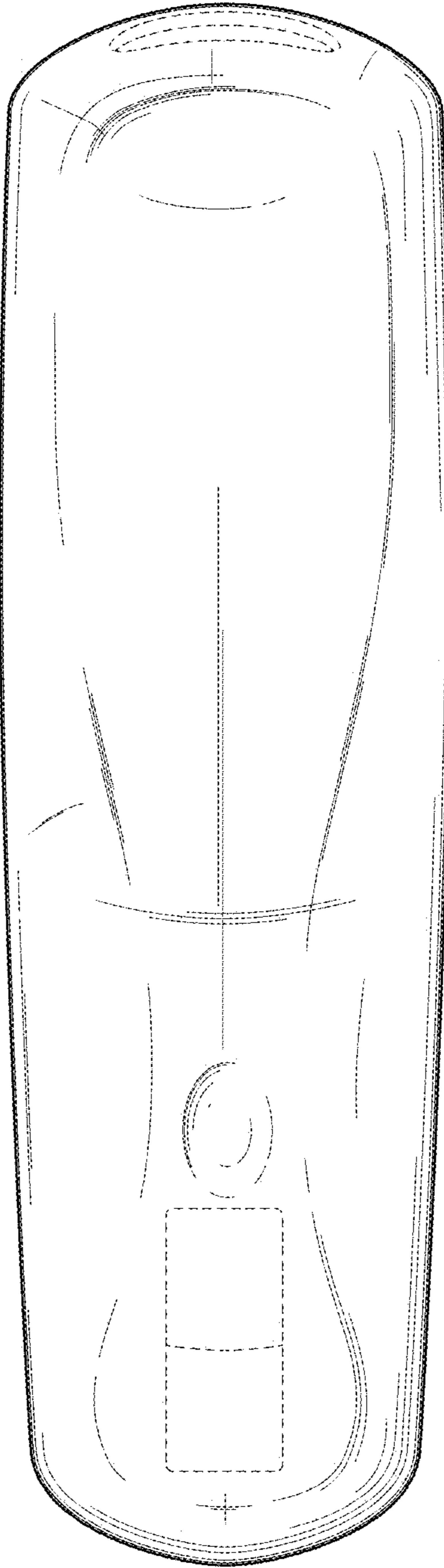

FIG. 2

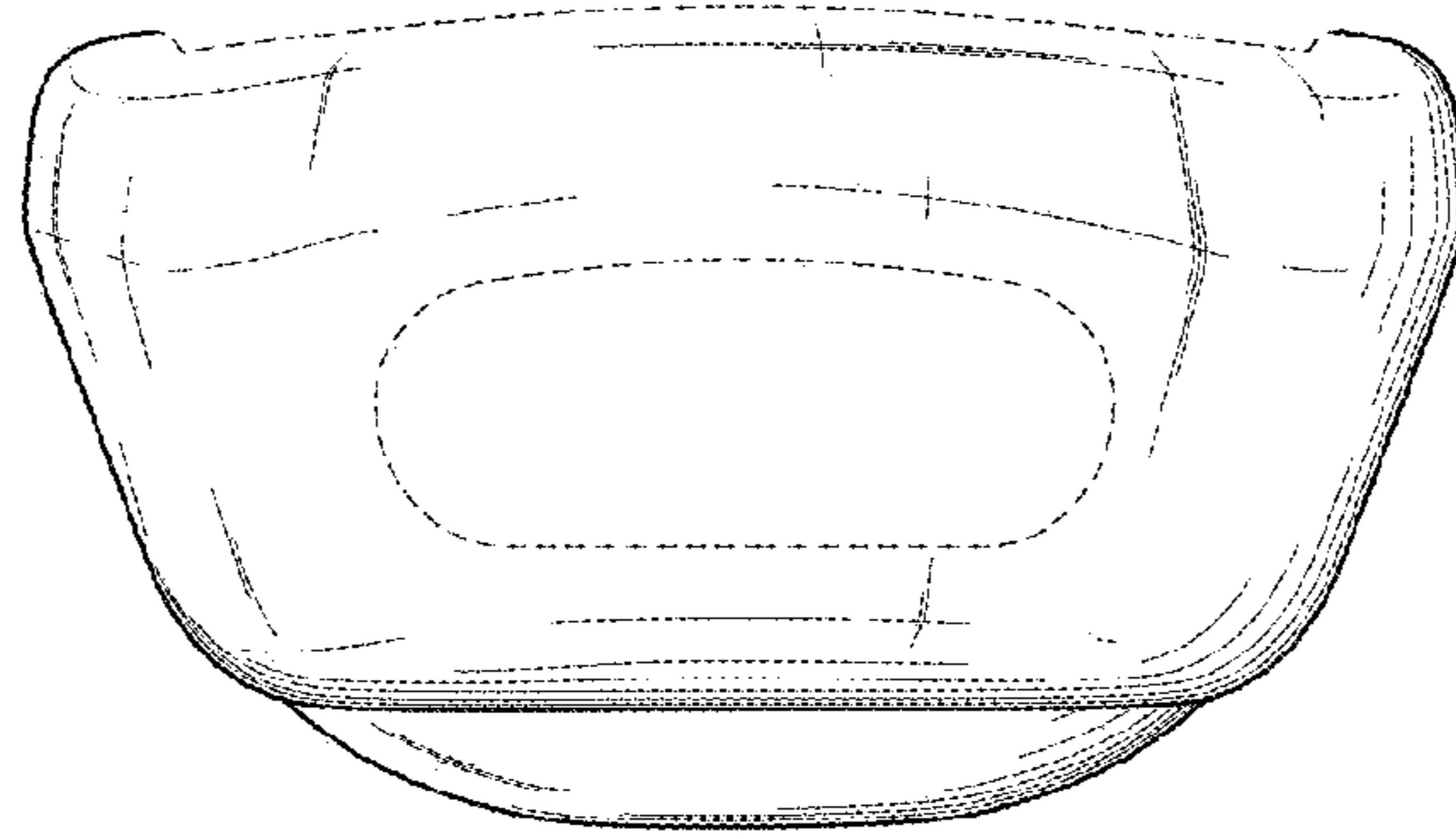

FIG. 3

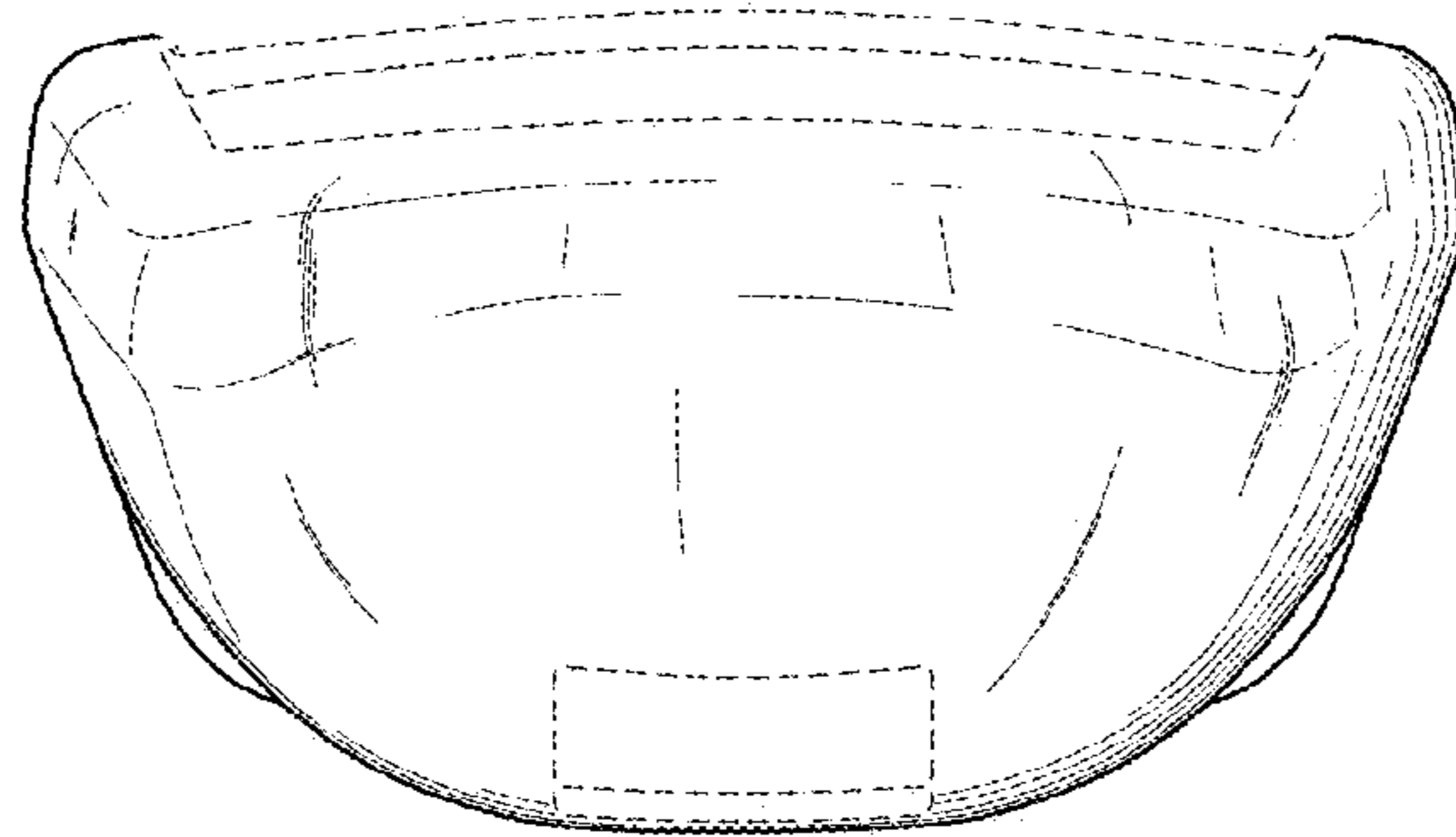

FIG. 4

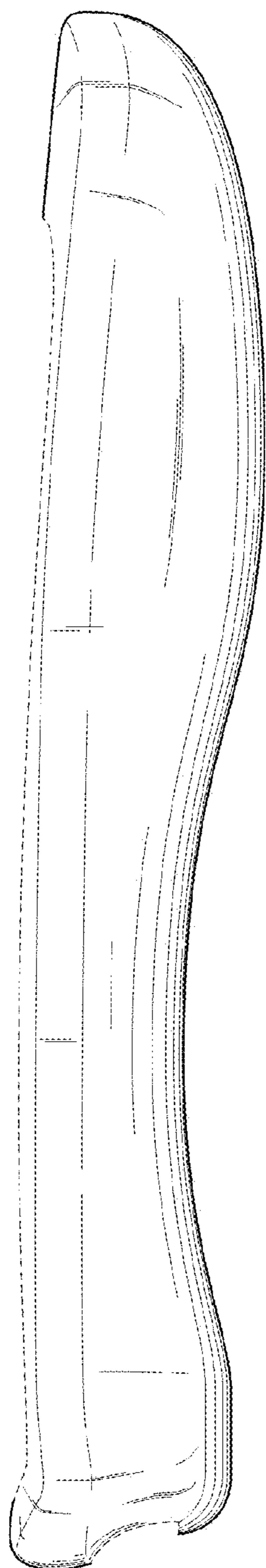

FIG. 5

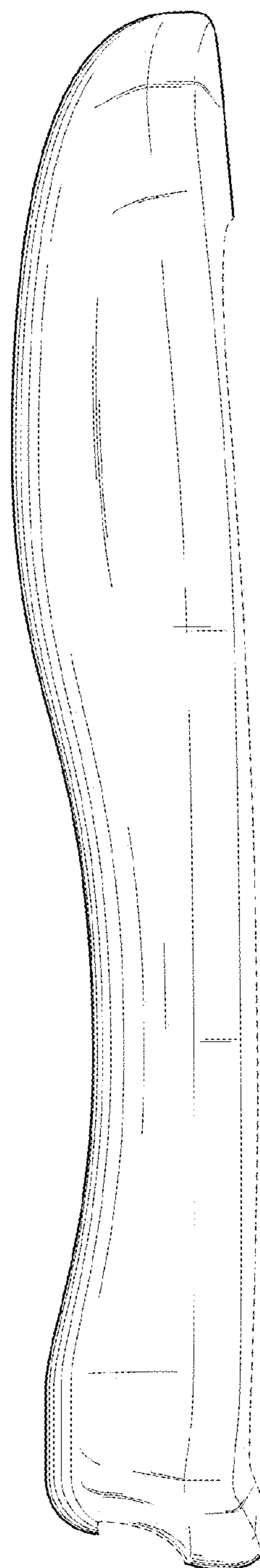

FIG. 6

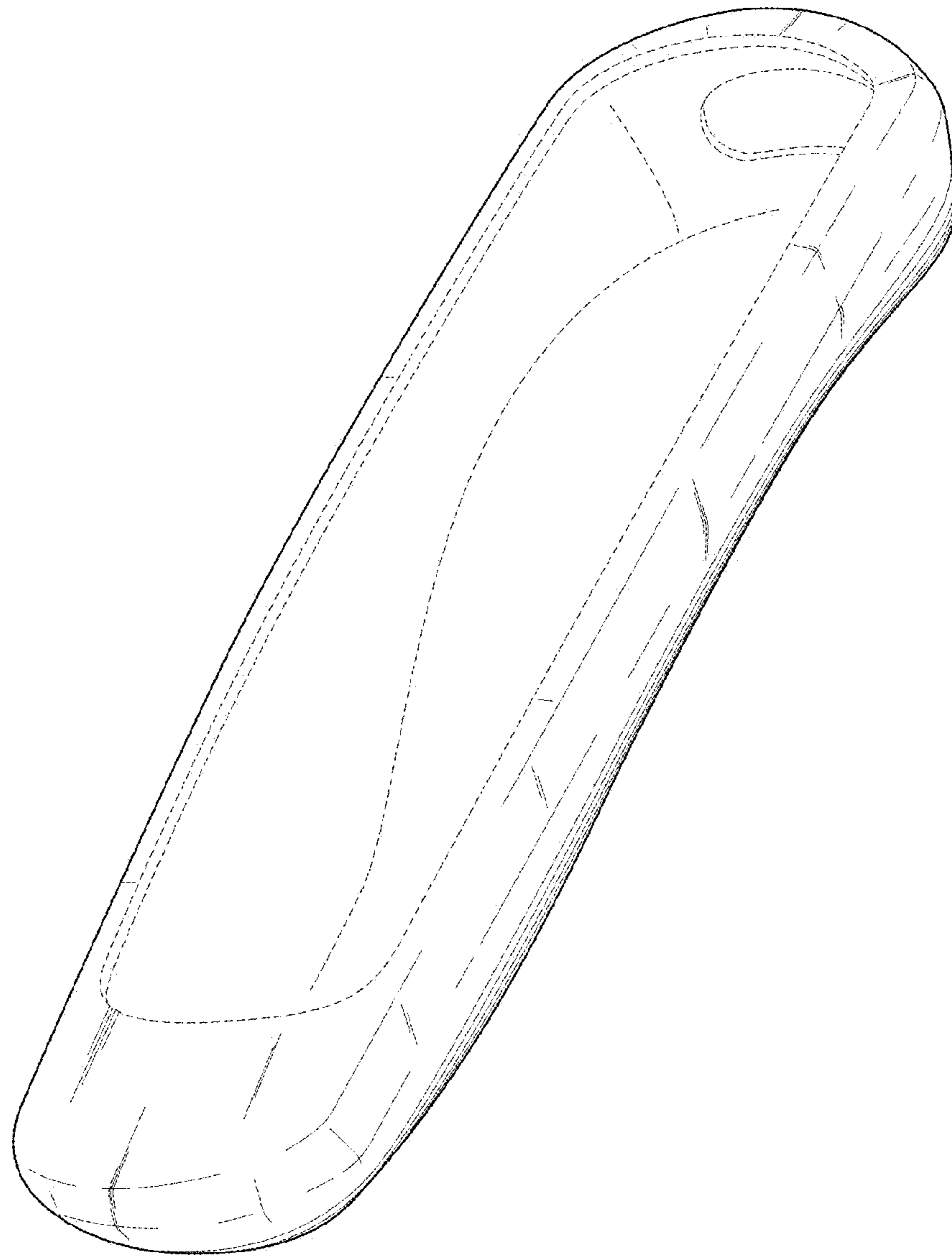

FIG. 7

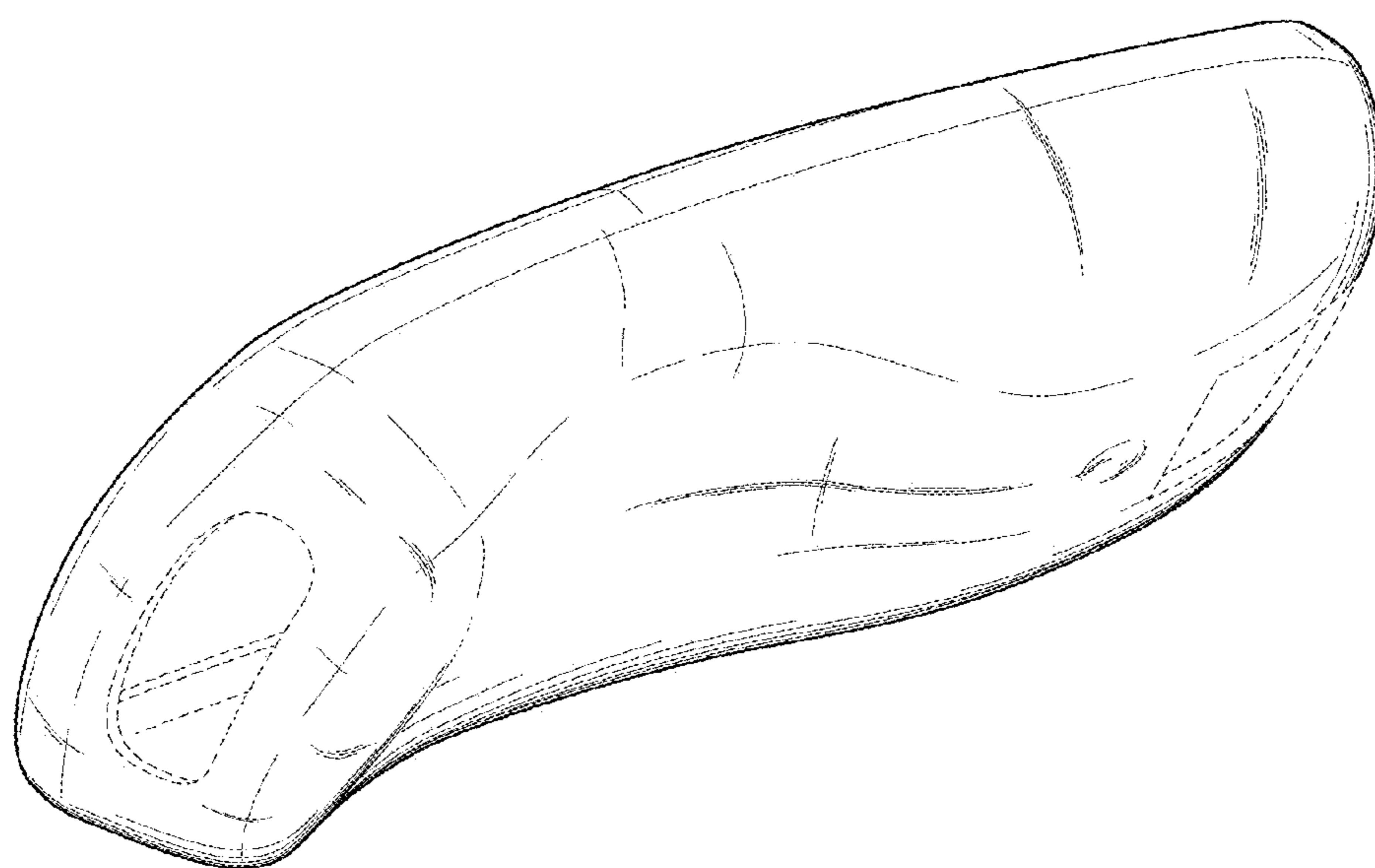

FIG. 8

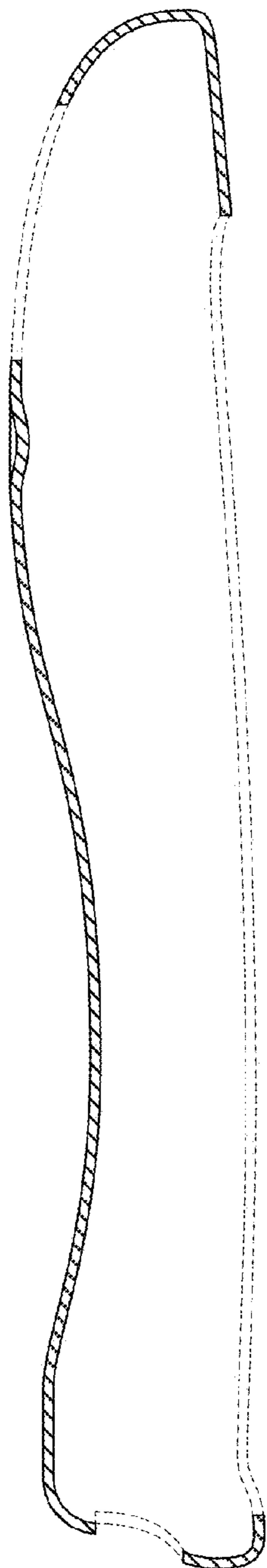

FIG. 9

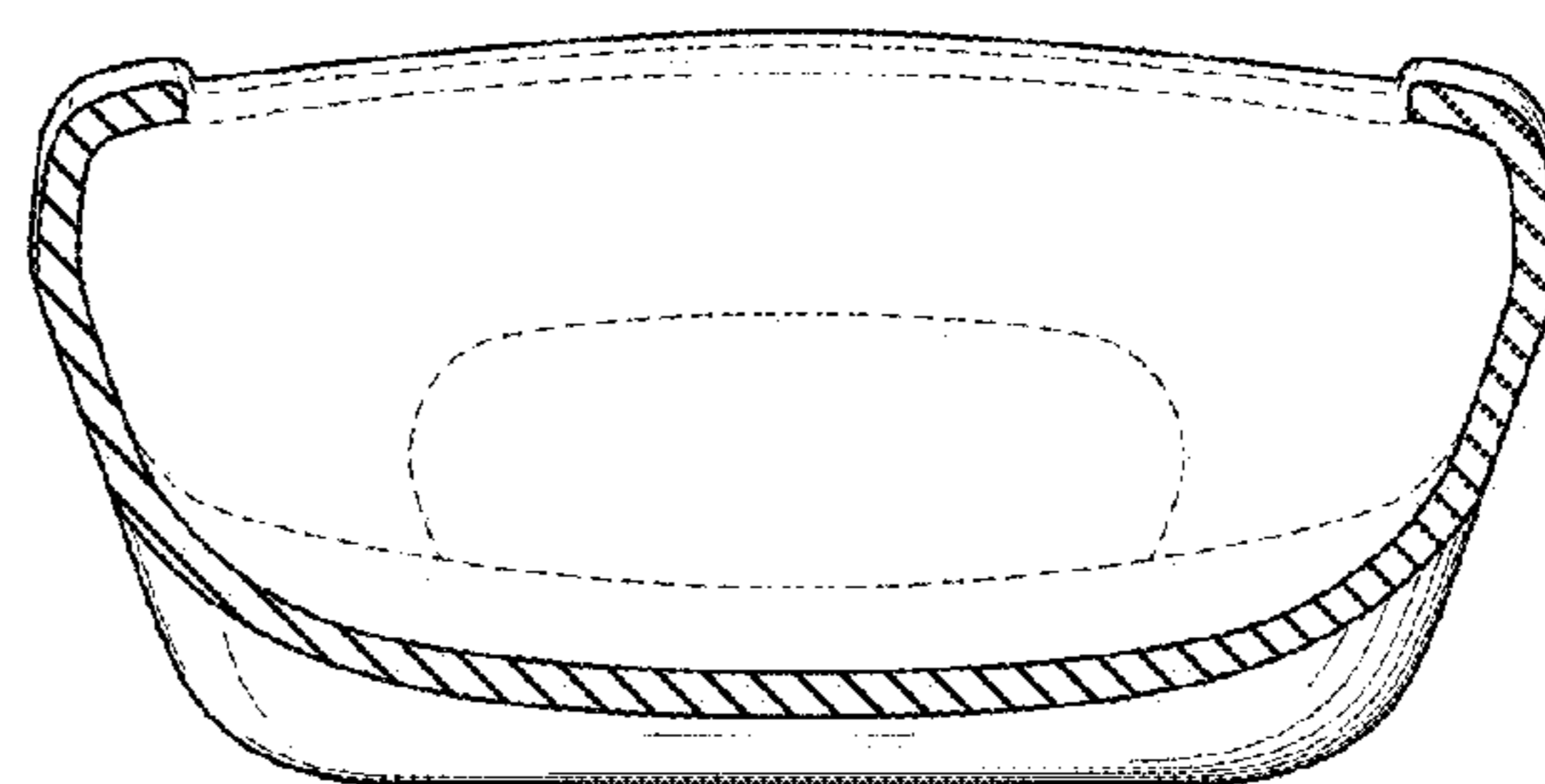

FIG. 10