



US00D710232S

(12) **United States Design Patent**
Bedrik

(10) **Patent No.:** **US D710,232 S**

(45) **Date of Patent:** **** Aug. 5, 2014**

(54) **HORN**

(76) Inventor: **Val Bedrik**, Elk Grove, CA (US)

(**) Term: **14 Years**

(21) Appl. No.: **29/430,251**

(22) Filed: **Aug. 23, 2012**

(51) **LOC (10) CI.** **10-05**

(52) **U.S. CI.**
USPC **D10/120; D14/187**

(58) **Field of Classification Search**
USPC D10/116.1-120; D14/187;
446/200-213; 116/142 FP
See application file for complete search history.

(56) **References Cited**

U.S. PATENT DOCUMENTS

D46,294 S *	8/1914	Rubes	D10/120
D46,404 S *	9/1914	Lougee	D14/187
1,941,233 A *	12/1933	Staley	181/126
3,450,226 A *	6/1969	Kessler	181/180
4,686,928 A	8/1987	Weisenberger		
5,460,116 A	10/1995	Gyorgy		

5,662,064 A 9/1997 Gyorgy
D487,030 S 2/2004 Davies
2006/0150890 A1* 7/2006 Cohen 116/142 FP

* cited by examiner

Primary Examiner — George D Kirschbaum
(74) *Attorney, Agent, or Firm* — Crossley Patent Law;
Micah C. Gunn

(57) **CLAIM**
The ornamental design for a horn, as shown and described.

DESCRIPTION

FIG. 1 is a right elevation view of a horn showing my new design;
FIG. 2 is a left elevation view thereof;
FIG. 3 is a front elevation view thereof;
FIG. 4 is a rear elevation view thereof;
FIG. 5 is a top plan view thereof;
FIG. 6 is a bottom plan view thereof; and,
FIG. 7 is an isometric view thereof.
The broken lines in FIG. 2 of the drawings depict a logo as environmental subject matter only and form no part of the claimed design.

1 Claim, 3 Drawing Sheets

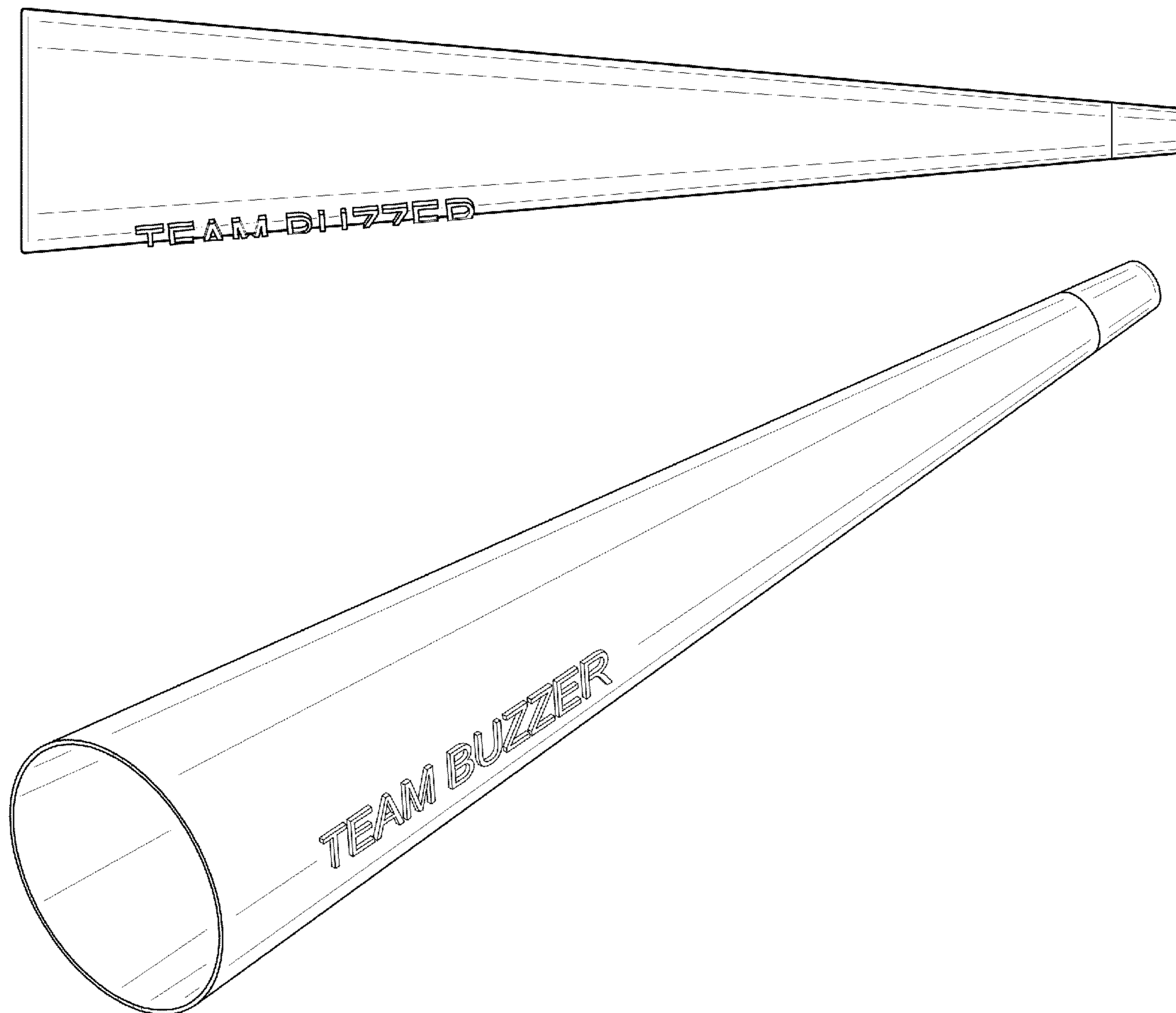

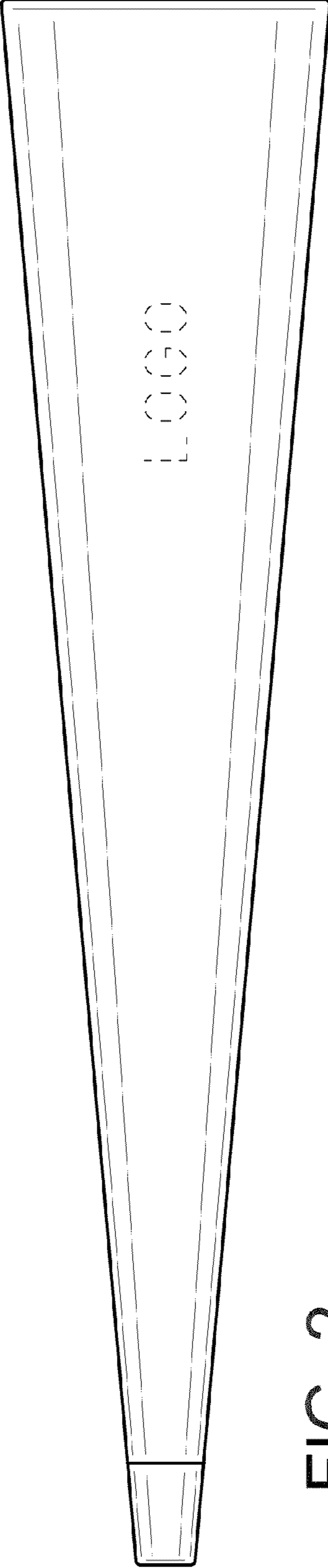
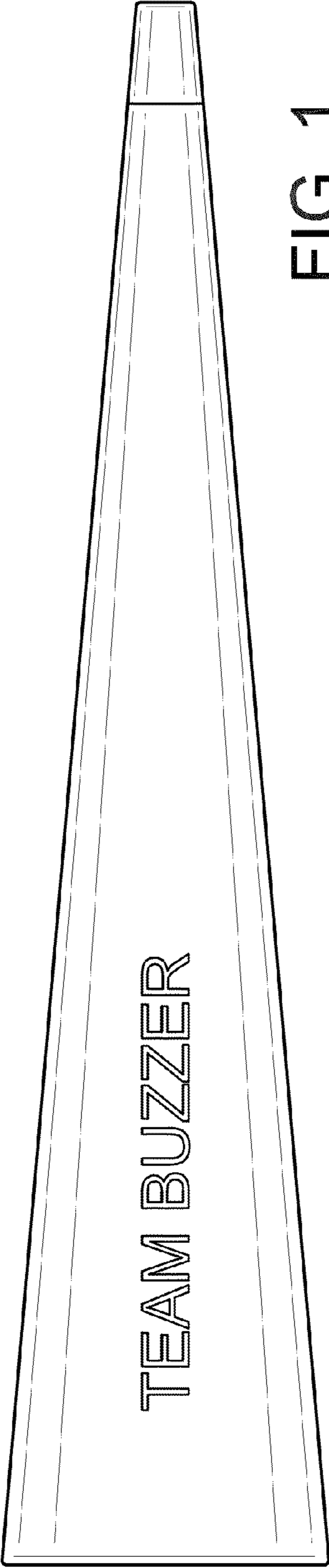

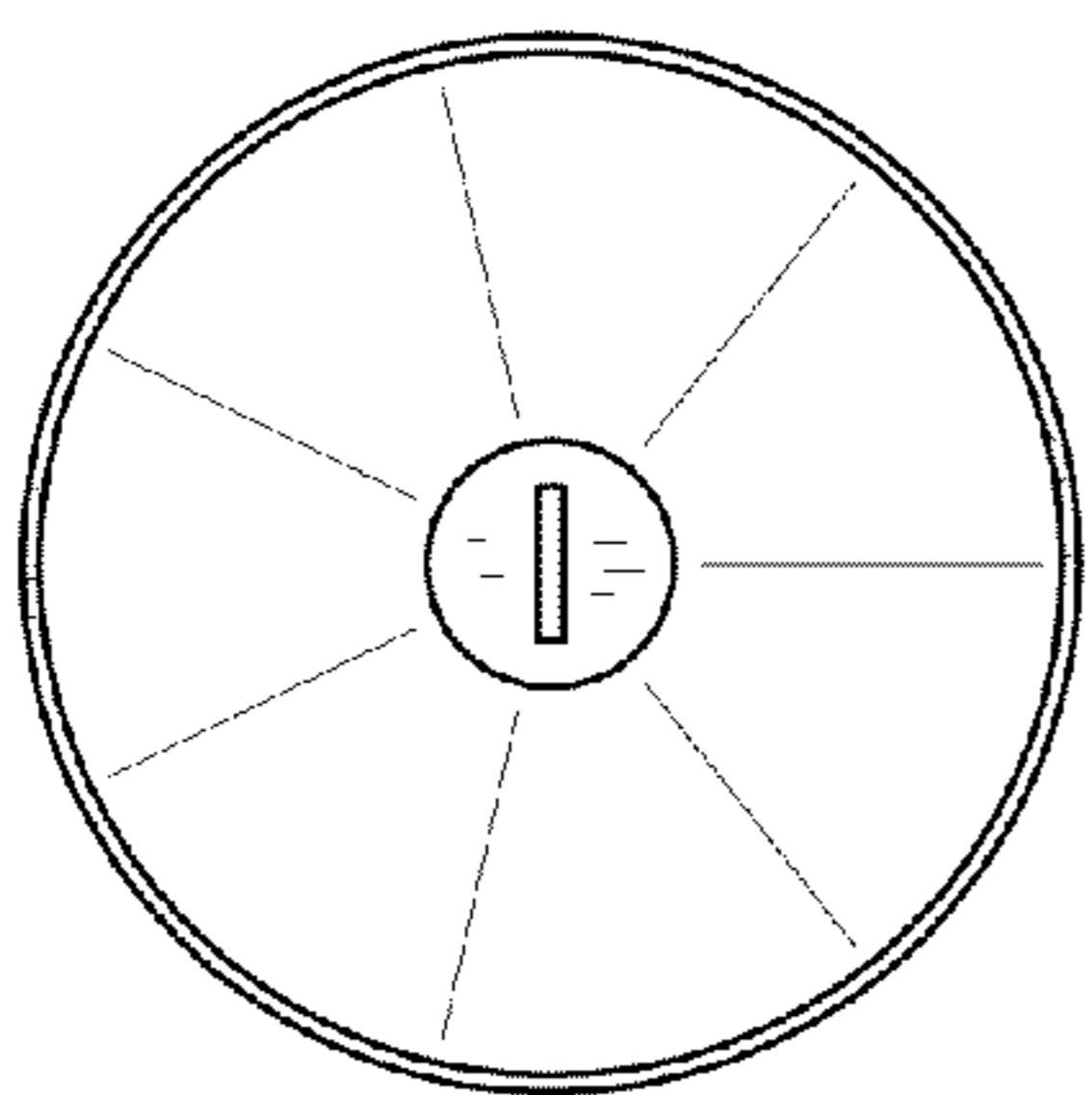

FIG. 3

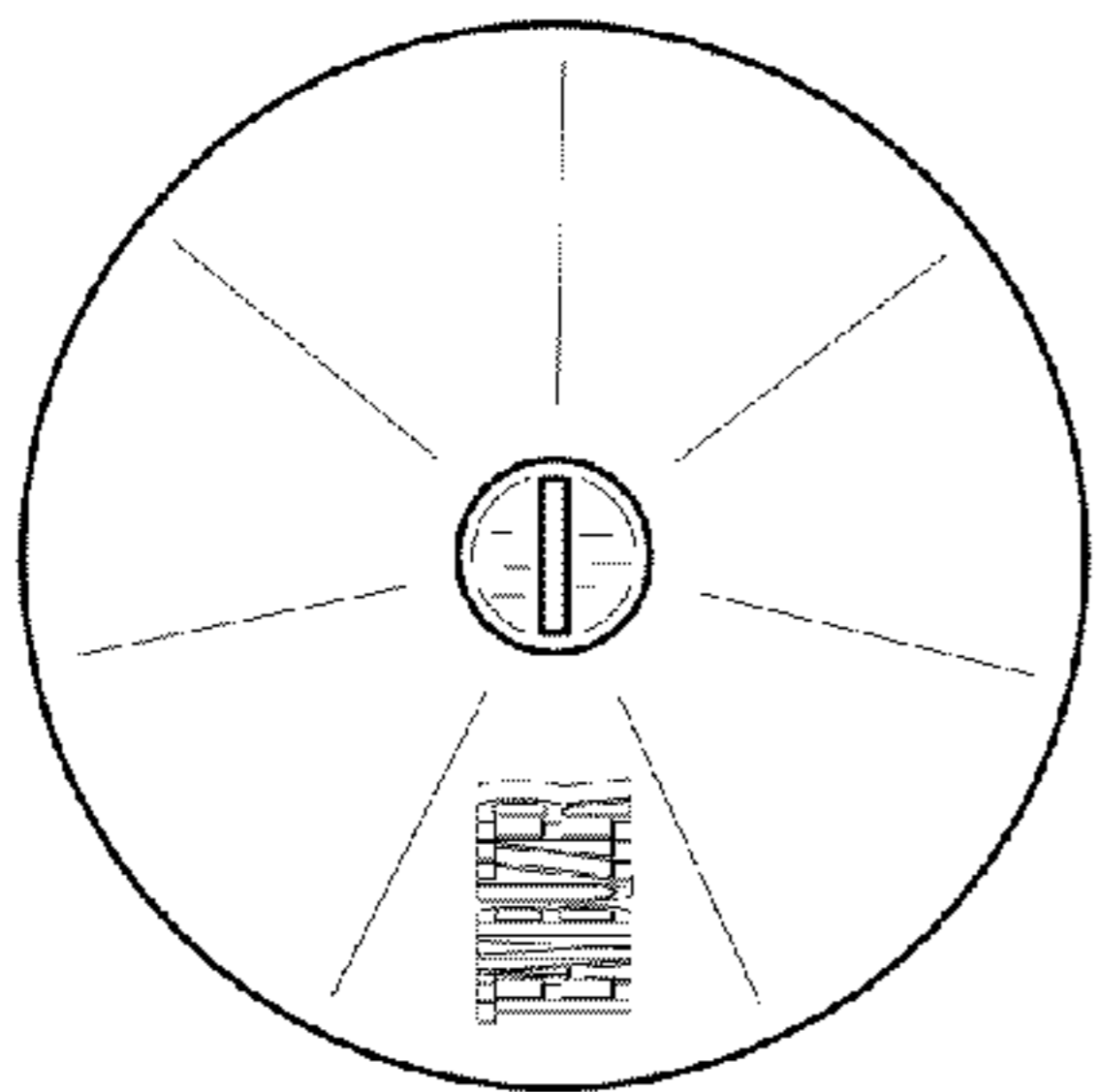

FIG. 4

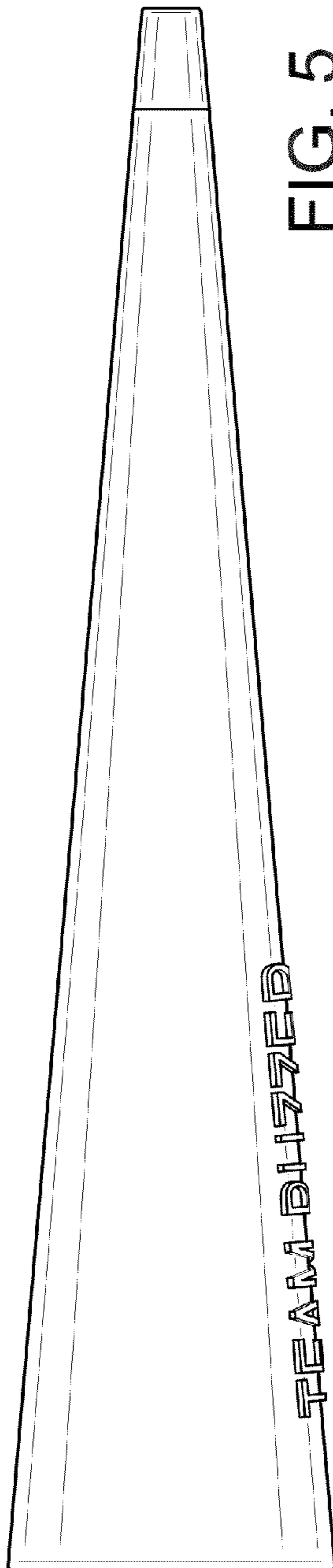

FIG. 5

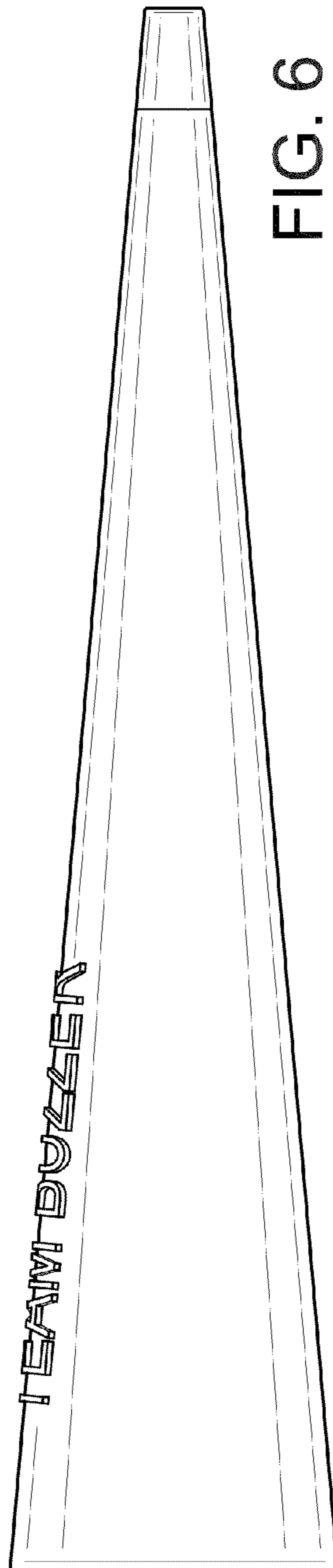

FIG. 6

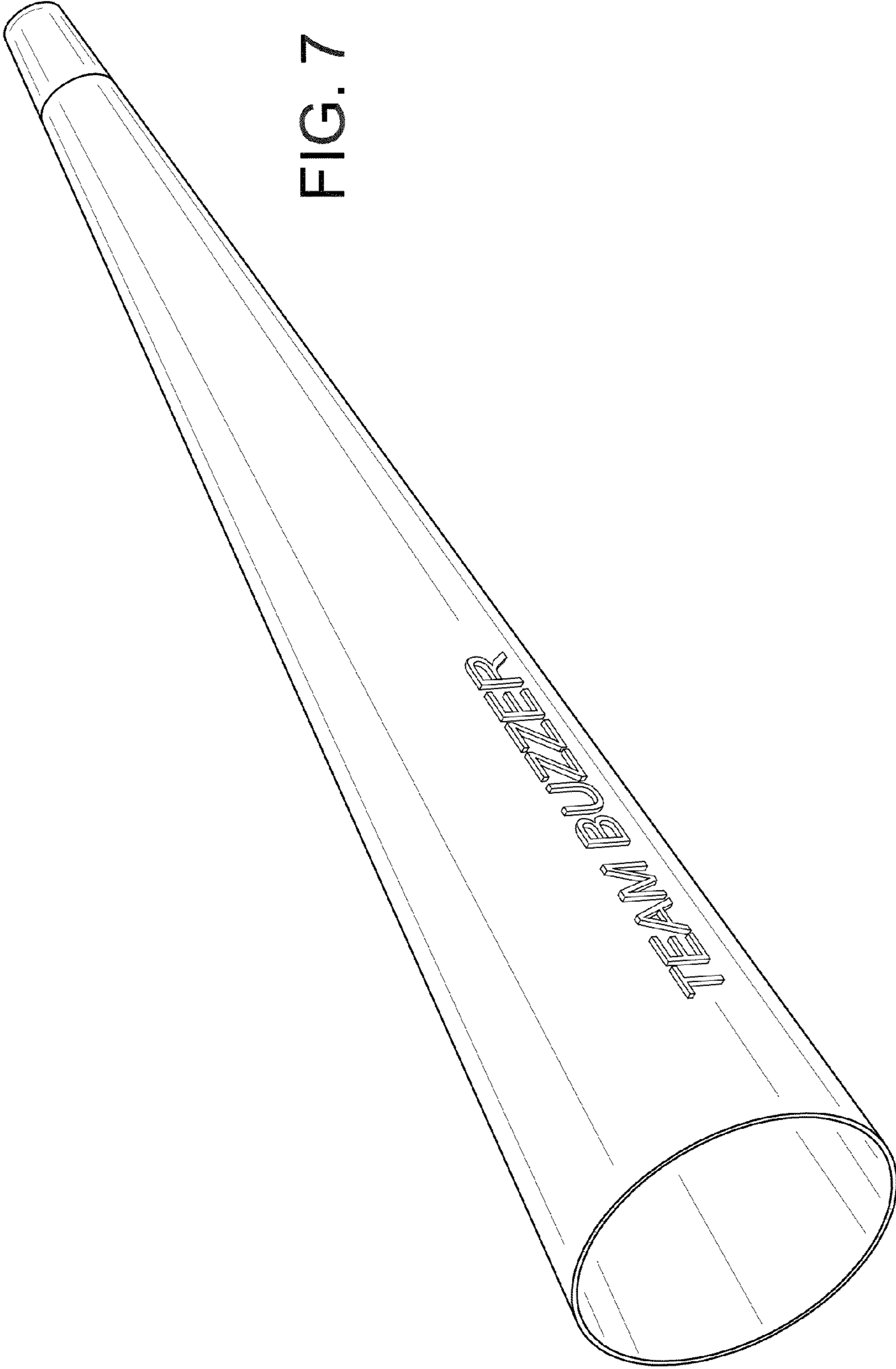

FIG. 7